



Smartmail Marketing Customer Guide

The guide and its amendments are available at canadapost.ca/postalguide

Effective May 1, 2023

Personalized Mail™



Send one to one

Postal Code Targeting



Discover similar customers

Neighbourhood Mail™



Reach every mailbox



Important updates

Posted on March 31, 2023	Effective on May 1, 2023		
Description of change	Location: Module	Location: Amendment/ Revision	Location: Section
New requirement for Neighbourhood Mail items weighing over 50 g	Service overview, Designing requirements, Preparing requirements, Depositing and General Terms and Conditions with a Standing Offer Agreement	v 2.0	Neighbourhood Mail Unacceptable items, Designing Neighbourhood Mail, Preparing Neighbourhood Mail, When depositing Neighbourhood Mail items, Section 9 Customer's Obligation

Posted on November 21, 2022	Effective on January 9, 2023		
Description of change	Location: Module	Location: Amendment/ Revision	Location: Section
Various modifications including updated the Data Schedule	Data and targeting	v 1.0	Throughout section
Clarified Unacceptable items for Postal Code Targeting	Service Overview	Amendment/ Revision v 1.0	Postal Code Targeting Unacceptable items

When the document is amended or revised, the version number will be modified as follows:

- an amendment increases the first digit in the version (e.g., version 2.0, 3.0)
- a revision increases the second digit in the version (e.g., version 1.1, 1.2)
- the version number restarts at 1.0 every January of a given year.

Helping you elevate the customer experience



Canada Post Smartmail Marketing™ provides a more intelligent approach to direct mail. Being able to leverage direct mail's physical power in combination with data intelligence will inspire stronger engagement and incite action, putting your brand in your customer's hand.



Direct mail gets noticed, opened and read, our brains are hard-wired to pay more attention to it. 74% of Canadian consumers always or sometimes notice advertising in direct mail.



Target and personalize your marketing message to reach the right people and increase its effectiveness. 86% of Canadian consumers open mail that's personally addressed to them.



Include direct mail in your marketing mix for greater attention, heightened emotional engagement and stronger brand recall. **Integrated direct mail and digital campaigns elicit 39% more attention** (time spent than digital campaigns alone).

Get better marketing results

Reaching the right audience, at the right time, with the right message is critical to marketing success. Millennials, GenXers and Boomers interact with media differently – driving them to act requires personalized communication and a full understanding of what motivates each group.



Marketing to Millennials

Don't believe the myth that Millennials only react to digital. Research shows that they eagerly engage with physical because they desire real experiences.

[Learn more. Get the report.](#)



Marketing to Gen Xers

Generation X is a small but powerful generation who were the first to grow up with the internet. Research shows they value physical, but are equally comfortable online.

[Learn more. Get the report.](#)



Marketing to Boomers

Boomers are more technically savvy than many think, but the fact remains – print is particularly powerful for this group. Research has shown that Boomers remain highly engaged with traditional media, and enjoy the tangible nature of direct mail.

[Learn more. Get the report.](#)

™ Trademarks of Canada Post Corporation.

Table of contents

Introduction	6
Process map	6
Useful links	6
Key support documents	7
How to reach us	7
Service overview	8
Smartmail Marketing at a glance	9
Features and options	11
Undeliverable Mail	13
Non-mailable matter	14
Solicitations by mail	14
Markings	14
Data and targeting	15
Information to help with your marketing campaign	17
Solutions at a glance	18
How to access Smartmail Marketing data	19
2023 data schedule	19
Audience insights	20
Pricing	21
Personalized Mail	22
Postal Code Targeting	22
Neighbourhood Mail	22
Designing requirements	27
Designing Machineable Mail – Standard items	28
Designing Machineable Mail – Oversize items	38
Designing Special Handling mail	43
Designing Neighbourhood Mail	48



Preparing requirements	52
Preparing Machineable Mail	56
Preparing Special Handling	60
Preparing Neighbourhood Mail	70
Creating an Order	76
How to place an Order	77
Additional information for Neighbourhood Mail items	79
Depositing	81
Required at the time of deposit	82
Find a Deposit Location	83
When depositing Neighbourhood Mail items	85
Paying and Terms	86
General Terms and Conditions with a Standing Offer Agreement	92
Appendices	103
Appendix A: Brick-piled mail items	104
Appendix B: Pallet construction specifications	106
Appendix C: Weighted average weight	107
Appendix D: Postal Code Targeting Orders	108



Introduction

Purpose of the customer guide

The *Smartmail Marketing Customer Guide* is designed to give information you need to get the most from the various solutions of direct mail. It explains the qualifications, and other terms and conditions under which these services are provided. Please ensure that you are using the most current version of the guide, including all amendments, which help you meet the requirements of the service.

Process map



Useful links

Quick links to supporting documents and tools:

General information

Addressing guidelines	canadapost.ca/addressing
Delivery standards	canadapost.ca/deliverystandards
Labels	canadapost.ca/labels
Non-mailable matter	canadapost.ca/nonmailable
Postal Indicia	canadapost.ca/postal-indicia

Tools

Electronic Shipping Tools (EST)	canadapost.ca/EST
Machineable Mail Advisor	canadapost.ca/mmadvisor
Precision Targeter™ –	
Neighbourhood Mail	canadapost.ca/precisiontargeter

Best practices

[Personalized Mail](#)
[Postal Code Targeting](#)
[Neighbourhood Mail](#)

Depositing mail

Deposit locations tool
canadapost.ca/depositlocations
Induction locations and cut-off times
canadapost.ca/cutofftimes

Customer guides

The guide and its amendments
canadapost.ca/notice

™ Trademarks of Canada Post Corporation.

Key support documents

Personalized Mail

[When to Say YES! Personalized Mail](#)

[How to videos – Machineable Mail](#)

[Machineable Mail – Self-Assessment Tool](#)

Postal Code Targeting

[Postal Code Targeting – Self-Assessment Tool](#)

[Sizing Template – Horizontal orientation](#)

[Sizing Template – Vertical orientation](#)

Neighbourhood Mail

[How to create a direct mail campaign in EST 2.0](#)

[How to create an Order in EST 2.0](#)

[EST 2.0 Neighbourhood Mail cheat sheet](#)

[How to import an NM import file into EST 2.0](#)

[Import File Specifications](#)

[Steps to export NM container labels as XML](#)

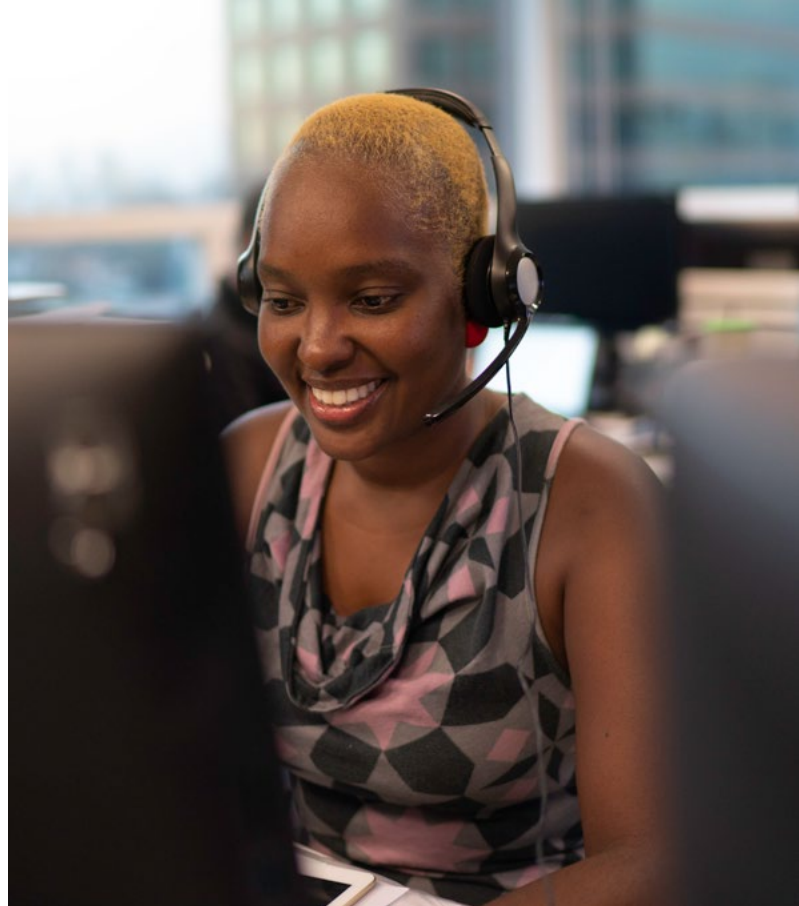

How to reach us

For enquiries regarding	Website/email	Call
General information on products and services	canadapost.ca/postalservices	Commercial Service Network 1-866-757-5480
Electronic Shipping Tools (EST)	canadapost.ca/newuser	Technical Help Line 1-877-376-1212
Payment and account information	cmg@canadapost.ca	Credit Management Group 1-800-267-7651
Data products and services	data.solutionscentre@canadapost.ca	1-877-281-4137

Smartmail Marketing
Service
overview



Smartmail Marketing™

Service overview

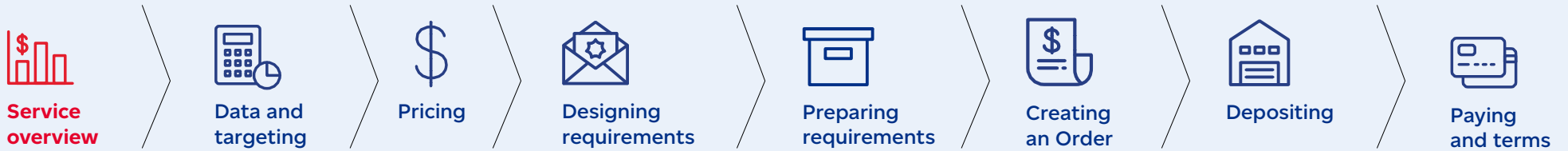

Smartmail Marketing at a glance

Description	Personalized Mail	Postal Code Targeting	Neighbourhood Mail
Service description	<p>Targets an address and/or individual.</p> <p>The intent is to motivate an individual to take action by:</p> <ul style="list-style-type: none"> • promoting a product, service, program or event; • soliciting donations or contributions. Includes thank-you letters soliciting future donations with a tax receipt from registered charitable organizations; • reporting on financial performance, primarily for promotional purposes; • supporting your loyalty card program (excludes credit and/or debit cards with or without reward points). <p>Mini-catalogues are acceptable as Personalized Mail. A mini-catalogue is defined as printed matter with a list of items for sale containing item description, item numbers and/or prices. Mini-catalogues must contain a minimum of eight pages or panels and meet Machineable Standard Personalized Mail service requirements.</p>	<p>Targets a defined postal code area.</p> <p>It helps to identify and reach postal codes that match the profile of your ideal prospects, so you can expand into new markets, target look-alike audiences, reach specific communities and optimize your targeting by suppressing existing audiences to focus on acquisition.</p>	<p>Targets a neighbourhood.</p> <p>Items consists of printed and non-printed matter such as product samples. The service provides the delivery of information and/or advertising material.</p> <p>Multiple formats are acceptable. Some examples are:</p> <ul style="list-style-type: none"> • catalogues • community newspapers • co-op mailings • flyers • samples
Unacceptable items	<p>Items with the primary intent to provide businesses and consumers with educational material, transactional or informational communications.</p>	<p>Voter Notification cards and ballots, or any item sent to an individual that has been personalized through content or creative artwork.</p>	<p>Any item that is considered non-mailable.</p> <p>Any item weighing over 50 g if such item has not received Canada Post's pre-authorization for deposit (see the Designing Neighbourhood Mail section for details).</p>

Description	Personalized Mail	Postal Code Targeting	Neighbourhood Mail
Minimum volume	<p>Machineable: 100 items</p> <p>Special Handling: 1,000 items</p>	<p>Machineable: 100 items</p> <p>Special Handling: 1,000 items</p>	<ul style="list-style-type: none"> • Complete distribution of one route; or the complete distribution to only residences, apartments, farms, businesses, or any combination, on a given route. • When mailing to more than one route: <ul style="list-style-type: none"> – Less than full coverage of a given route is permitted (these items will be delivered in no particular order until depleted).
Delivery standards ^{1,2}	<p>Machineable</p> <p>Major urban centres: 3 - 5 business days</p> <p>Non-major urban centres: 3 - 5 business days</p> <p>Northern/remote centres: 3 - 9 business days</p> <p>Machineable Oversize and Special Handling</p> <p>Major urban centres: 3 - 8 business days</p> <p>Non-major urban centres: 3 - 9 business days</p> <p>Northern/remote centres: 3 - 13 business days</p>	<p>Machineable:</p> <p>Major urban centres: 3 - 5 business days</p> <p>Non-major urban centres: 3 - 5 business days</p> <p>Northern/remote centres: 3 - 9 business days</p> <p>Special Handling:</p> <p>Major urban centres: 3 - 8 business days</p> <p>Non-major urban centres: 3 - 9 business days</p> <p>Northern/remote centres: 3 - 13 business days</p>	<p>Transportation time</p> <p>Major urban centres³: 2 - 7 business days</p> <p>Non-major urban centres: 2 - 9 business days</p> <p>Northern/remote centres: 2 - 13 business days</p> <p>Comprised of two components, transportation time and delivery cycle,⁴ which added together determine the delivery standard.</p> <p>Delivery cycle</p> <p>Thickness/weight = days</p> <p>19 mm (0.75 in.)/up to 200 g = up to 3 days</p> <p>25 mm (1 in.)/up to 300 g = up to 4 days</p> <p>25 mm (1 in.)/up to 500 g = up to 9 days</p>
Features	<ul style="list-style-type: none"> • Mail Forwarding 	N/A	<ul style="list-style-type: none"> • Consumers' choice
Options	<ul style="list-style-type: none"> • Return Address • Return to Sender 	N/A	<ul style="list-style-type: none"> • Transportation • Specified delivery start date

1. Delivery standards are calculated from the day of deposit (day 0) plus the number of business days required for delivery. The number of days excludes the day of the mailing, weekend and statutory holidays. Weekend and statutory holiday deposits are considered deposited on the following day.
2. Estimates in business days. Delivery standards are not guaranteed. Detailed information can be found at: canadapost.ca/deliverystandards.

3. Transportation time applies to moving local mail to other facilities within that geographic area. In all other areas (e.g., rural), local means the specific delivery office from which the items will be delivered.
4. For non-letter carrier routes, the delivery cycle, in business days, is 1 day for items up to 500 g (17.64 oz.) and 3 to 5 days for items up to 1,000 g (35.3 oz.) with a maximum thickness of 3.81 cm (1.5 in.).

Features and options

A **feature** is part of the basic service. An **option** is a service enhancement that is not provided automatically as part of the basic service.

Personalized Mail

Features

Mail Forwarding

Items that cannot be delivered as originally addressed because the addressee has moved will be forwarded to the addressee at no extra charge while there is a Mail Forwarding request in effect.

Mail bearing the name of the addressee followed by the words “OR OCCUPANT” or similar wording, or mail bearing a non-personalized descriptor, such as “OCCUPANT”, will not be forwarded. In such cases, the item will be delivered to the original destination address.

Mail Forwarding is not available for items in the Dimensional Personalized Mail category.

Options

Return Address

If a return address is used, there must be only one return address showing and it must be Canadian. Dual return addresses are also acceptable as long as there is one Canadian return address. Canada Post does not return items to addresses outside of Canada.

The return address printed on the item may vary provided the mailing originates from the same mail owner (e.g., customer number must be the same on all items).

Return to Sender

Personalized Mail items that cannot be delivered as originally addressed will be returned to the sender if:

- the Return to Sender option was selected at the time the Order was created
- the item carries the correct Return Postage Guaranteed postal indicia. Visit canadapost.ca/postal-indicia for more information regarding this postal indicia
- no Mail Forwarding request in effect for that addressee, and
- only one return address appears on the outside of the item and that address is Canadian.

If there is no Mail Forwarding service in effect for the addressee and if the item does not bear the correct Return Postage Guaranteed postal indicia, the item will be treated as undeliverable and disposed of or recycled, as determined by Canada Post.

Mail bearing the name of the addressee followed by the words “OR OCCUPANT” or similar wording, or mail bearing a non-personalized descriptor, such as “OCCUPANT”, will not be returned to the sender. In such cases, the item will be delivered to the original destination address.

Return to Sender is not available for Dimensional Personalized Mail category or for metered items. Those items will be treated as undeliverable.

Postal Code Targeting

Features

Suppress your customers

Leverage the power of suppression and only target new prospects. Suppression is free up to a maximum of 25,000 records. If the data request is over 25,000 records, then you will be allowed two times the quantity requested for suppression. Suppression records above and beyond these limits will be subject to a fee.

Targeting Data

Use data insights to select your best postal codes (included with your campaign).

Summary Report

A summary report outlining the number of postal codes and addresses mailed to for post-campaign analysis.

Neighbourhood Mail

Features

Consumers' Choice

You can target more effectively by respecting the wishes of consumers who indicate that they do not wish to receive unaddressed material.

When a Canadian opts into Consumers' Choice, we will continue to deliver:

- Community newspapers (see the [Creating an Order](#) section).
- Mailings in the public (as opposed to commercial) interest from government departments/agencies at federal, provincial, territorial, municipal levels and band councils.
- Materials from Elections Canada, provincial/territorial chief electoral officers and municipal election officials (or the deputy returning officer), including material from political parties and electoral candidates during an election.

Visit canadapost.ca/precisiontargeter for the breakdown of delivery points with and without these notices.

Options

Transportation

If you wish to deposit the entire mailing at a single deposit location, we will transport your items to the delivery office(s) for a fee. There is no transportation fee when you transport your items directly to the appropriate delivery facility(ies).

Specified delivery start date

If you wish to specify a delivery start date for your entire mailing (i.e., begin delivery on the same day in all delivery installations), you must select this option when you create your Order in EST.

For specific deposit requirements, see the "[Depositing](#)" section.

Undeliverable Mail

Personalized Mail

Items are treated as undeliverable if:

- the item does not bear a complete and valid address
- the item is addressed to a non-existent address
- the addressee refuses the item
- delivery is prohibited by law
- the item cannot otherwise be delivered to the address.

We will either dispose of or recycle Undeliverable items at our discretion.

Postal Code Targeting

Items are undeliverable if:

- the non-personalized address is invalid or unreadable
- the addressee refuses the item
- delivery is prohibited by law
- the item cannot otherwise be delivered to the address.

We will either dispose of or recycle Undeliverable items at our discretion.

Neighbourhood Mail

We will either dispose of or recycle Undeliverable items at our discretion.

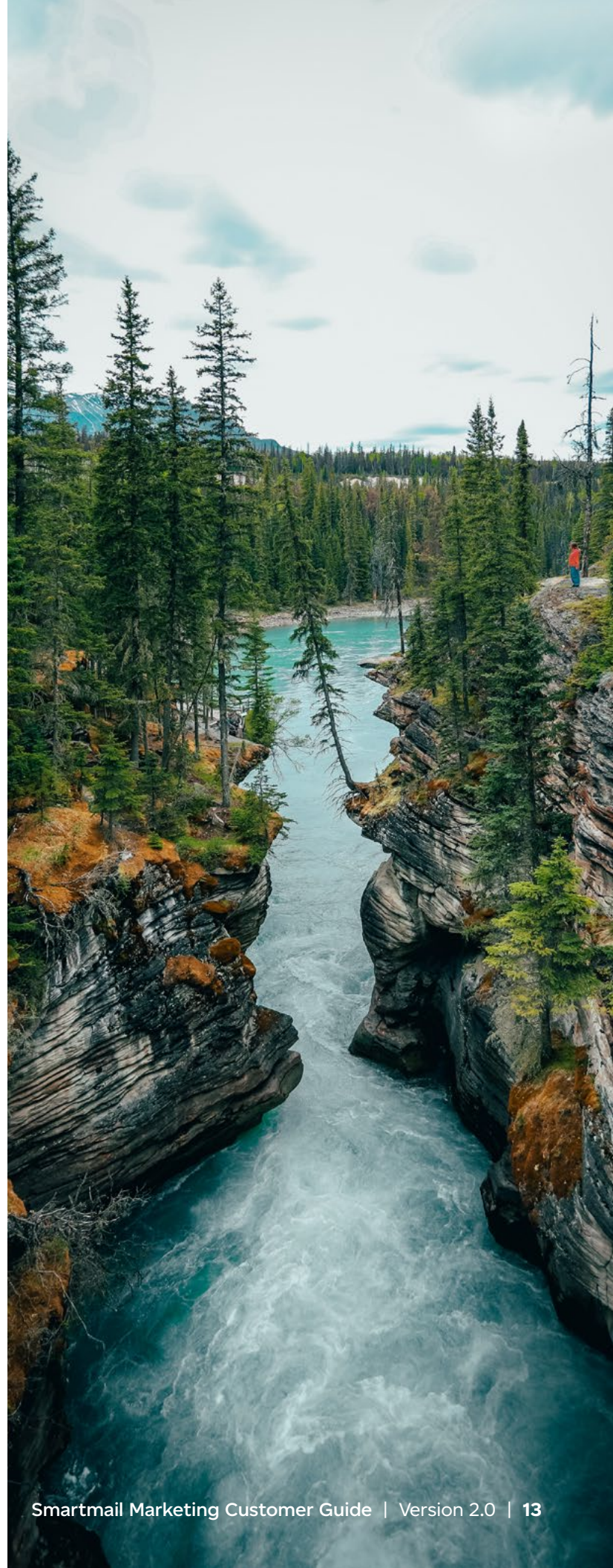

Non-mailable matter

Generally, non-mailable matter means any mail that:

- is prohibited by law (e.g., illegal, obscene, fraudulent)
- is non-mailable due to the fact that it fails to meet certain physical characteristics or marking requirements
- contains products or substances that could:
 - injure a person handling the mail
 - damage postal equipment or other items
 - trap other items

Solicitations by mail

Solicitations (offers) having the general appearance of a bill, invoice, or statement of account where there is no obligation to make a payment in relation to the offer unless accepted, must adhere to the regulatory obligations detailing wording and format

Markings

Customers may use the “Delivered by” logo on items delivered by Canada Post with the prior written consent of the Director, Marketing and Brand or her/his designate. They can be contacted at info.brand@canadapost.ca. Visit canadapost.ca/logo for available artwork.

Any unauthorized use is an offence under the [Canada Post Corporation Act](#) and Regulations as well as being an infringement of Canada Post’s trademarks and official marks.

An item will be considered non-mailable if, on the outside, it is marked or labelled with any of the following that were not provided or authorized by Canada Post:

- Certain markings that could be confused with Canada Post’s designators, services, or indicia. These must not be used. Some examples include:
 - any design likely to be mistaken for a postage stamp, meter impression, service label or any other mark suggesting that postage has been paid,

- contains cannabis. Refer to [ABCs of mailing](#) of the *Canada Postal Guide* for specific requirements on the promotion of cannabis.
- contains sexually explicit material unless it is sent in an opaque envelope with the words “ADULT MATERIAL” or similar wording.

For information on unacceptable items, refer to the [Non-mailable Matter](#) section of the *Canada Postal Guide*.

requirements. For the official requirements of the [Solicitations by Mail Regulations](#) made under the [Canada Post Corporation Act](#), go to the government of Canada, Justice Laws website.

- any label or endorsement implying that it will be given special handling, delivered faster, such as Priority Mail, Express Mail, or be provided with any service that has not been purchased by the customer. (However, the customer may include labels on items that are directed to the addressee as an instruction that is clearly related only to the enclosure and would not otherwise result in the item being non-mailable matter. Examples of acceptable wording include “URGENT”, “RUSH” and “IMPORTANT COMMUNICATION ENCLOSED”), and
- any facsimile of any label, endorsement or marking used by Canada Post that might cause confusion so as to affect its handling, e.g., confusion as to the service the customer has paid for.

It is your obligation to obtain approval for any proposed endorsement or other markings from Canada Post prior to printing.



Smartmail Marketing Data and targeting

Find and target the right audience
to increase sales, gain insights and
reduce costs



Smartmail Marketing™

Data and targeting

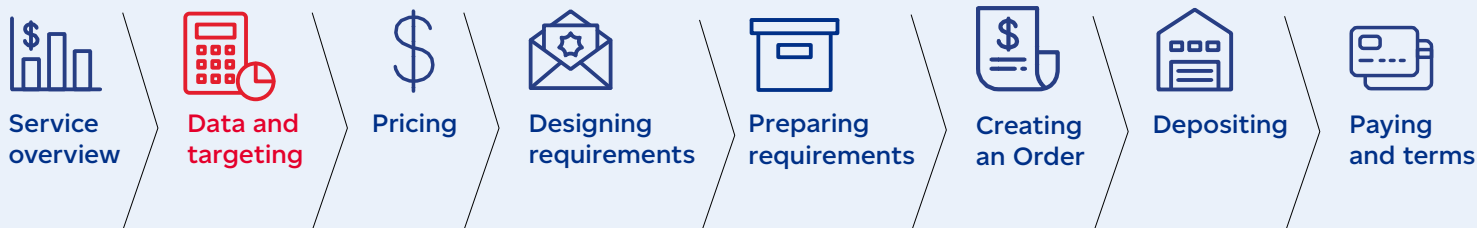

Data and Targeting provides a more in-depth look at Canada Post Data and Targeting Solutions as a component of Smartmail Marketing. Maximize the impact of your message by using data to target top customers/prospects, get your brand directly into the right hands and boost response rates in a cost-effective way.

1. Customer

Identify prospect customers who are more likely to buy your products and services.

2. Cost saving

Save money by not creating or mailing items that are not relevant to the recipient.

3. Result

Maximizes your return on investment.

4. Targeting your audience

- Know your customer base:
 - what is their behaviour?
 - where do they live?
 - what is their lifestyle?
 - which demographics are they part of?
- If you do not have a customer base:
 - use your geographic location to identify potential areas to mail.

5. Canada Post's targeting options

- Interests and Behaviours (e.g., hobbies, interests, travel, online shopping, etc.)
- Address Attributes (e.g., consumer names, telephone numbers, dwelling types, etc.)
- Lifestyle and Life Stage (e.g., Entertainment Fans, New Parents, Just Married, Movers, etc.)
- Demographics (e.g., age range, gender, income, education, etc.)

Information to help with your marketing campaign

Options	Personalized Mail	Postal Code Targeting	Neighbourhood Mail
Coverage	Mailing address (one address)	Postal code (approx. 20 addresses) by delivery mode	Postal routes (walks) (approx. 500 addresses) by delivery mode
Data	Provide a list of your current customers or targeted list rental.	Identify the postal codes you want to target and suppress your existing customer addresses from the list.	Target the best routes based on geography, and demographic information.
Addressing	Full address with or without a name	<p>Machineable: The PCT non-personalized address file is requested and received from Canada Post. The PCT file will be used to print the non-personalized address for Canada Post to deliver to the recipient.</p> <p>Special Handling: The PCT non-personalized address file is requested and received from Canada Post. The PCT file will be processed by a recognized SERP vendor for use in print and preparation for induction to Canada Post for delivery to the recipient.</p>	None

Applies to Neighbourhood Mail only: Target locally or nationally, directing the message to an area as small as a single postal route or to many postal routes across the country. You can further refine your targeting to reach specific address types.

Target the message to:

Houses

Include residential dwellings that may be: detached, semi-detached or attached in a row. These dwellings have separate entrances.

Apartments

Include self-contained residential units within a high-rise or low-rise multiple-unit building of three or more such units with a common main entrance to the building.

Businesses

Include buildings and structures where the primary activity is commercial, industrial or institutional (institutional includes but is not limited to churches, hospitals, nursing homes, and schools).

Farms

Include residential and business buildings associated with a defined area of land (e.g., fields) used to grow crops, raise animals or fish.

If a business is operated from a house or apartment which is also a residence, the point of call is classified as a house or apartment.

Where does it fit in your marketing plan?

When planning a mailing, there are two important steps that should be included in a campaign timeline after objectives and budgets are allocated:

1. **Campaign sizing:** Request a count for the target market you plan to mail to, including key targeting criteria. This step takes approximately 3 to 5 business days. A count request provides you with the estimated number of mail items that should be printed.
2. **Request your list:** Request data to match your count request. This step should be made well in advance of the print date and will take 5 to 10 business days to complete.

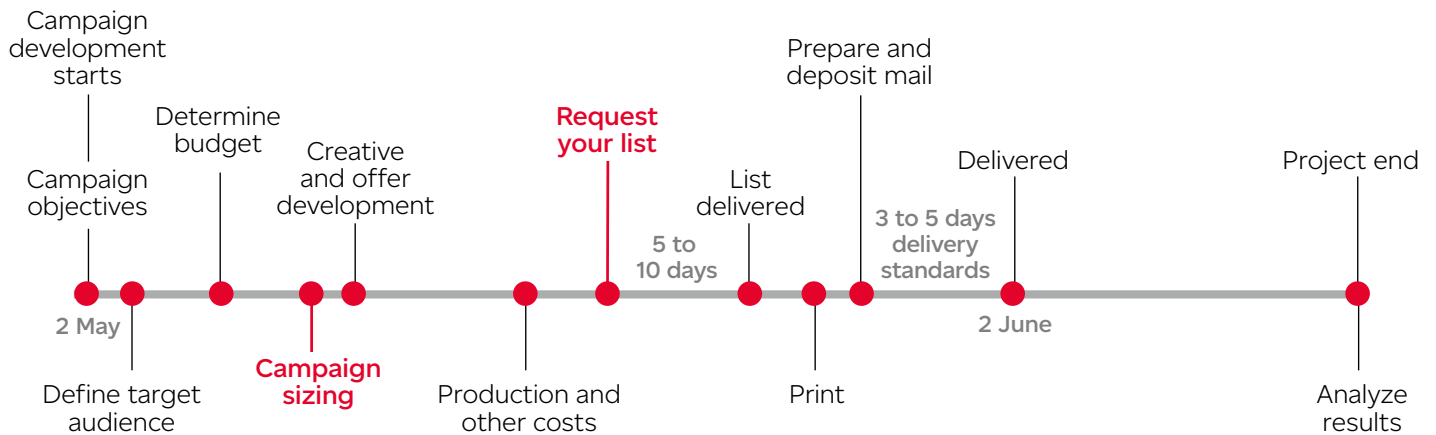

Solutions at a glance

Category	Personalized Mail	Postal Code Targeting	Neighbourhood Mail
Insights	Use data intelligence to uncover who your best audience is and where they live. These insights can be used to design campaign strategies that align to your goals.	Same as Personalized Mail	Same as Personalized Mail
Targeting	<ul style="list-style-type: none"> • Consumer lists • Business lists • Data Management Services • Professional Services 	<ul style="list-style-type: none"> • Professional Services • Industry Software 	<ul style="list-style-type: none"> • Professional Services • Precision Targeter
Measurement	Measure the results and impacts of your Smartmail Marketing campaign with Response Analysis and Foot Traffic Attribution.	Same as Personalized Mail	Same as Personalized Mail
Licensed Data Products	<ul style="list-style-type: none"> • Point of Call Address Data 	N/A	<ul style="list-style-type: none"> • Householder Data • Householder Elite Data

Canada Post can provide the most comprehensive compiled list that meets our addressing standards. Lists can include business names, consumer names, names where available or address only. Enhance your targeting data by targeting based on attributes that match your best prospects. Accessing lists or data from Canada Post is easy.

How to access Smartmail Marketing data

Talk to an expert by completing our [online form](#), an agent will review your submission and contact you.

If you have questions you can call us at 1-877-281-4137.

When does Canada Post upload data files?

For those interested in building and measuring their own Personalized Mail or Neighbourhood Mail campaigns, Licensed Data Products are available.

We make new data files available each and every month to ensure that you are always using the most up-to-date data. Once a Data Agreement has been completed and signed, we will provide you with the FTP Portal information for you to access the data going forward.

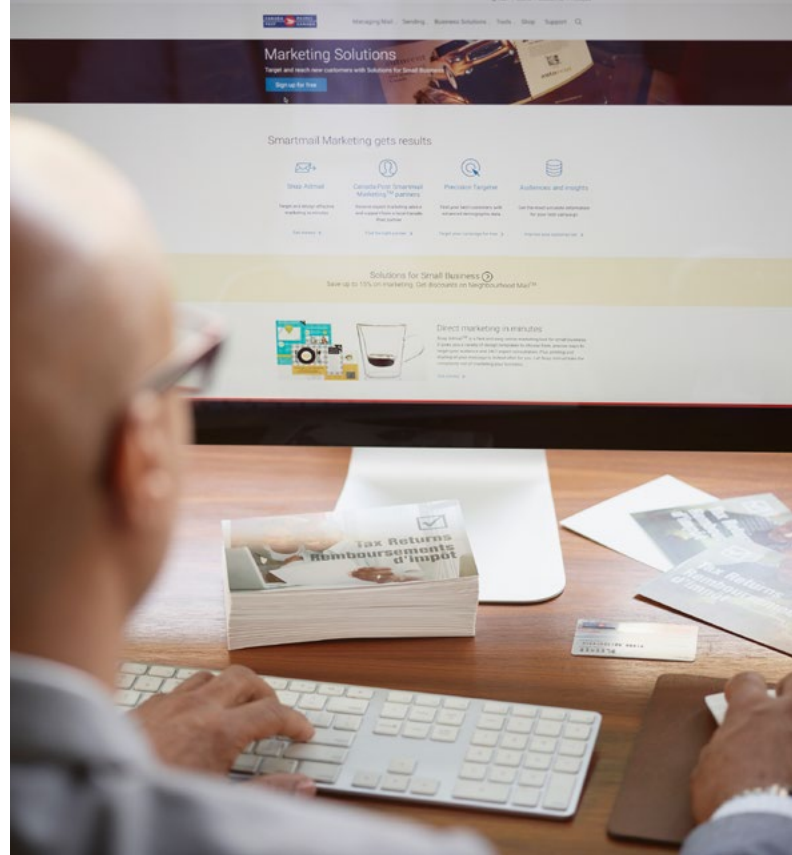

2023 data schedule

Data posted to FTP site	Restructure implementation date	Valid for mailings from
December 9, 2022	January 16, 2023	January 13, 2023 to February 16, 2023
January 6, 2023	February 20, 2023	February 17, 2023 to March 16, 2023
February 10, 2023	March 20, 2023	March 17, 2023 to April 13, 2023
March 10, 2023	April 17, 2023	April 14, 2023 to May 11, 2023
April 7, 2023	May 15, 2023	May 12, 2023 to June 15, 2023
May 5, 2023	June 19, 2023	June 16, 2023 to July 13, 2023
June 9, 2023	July 17, 2023	July 14, 2023 to August 17, 2023
July 7, 2023	August 21, 2023	August 18, 2023 to September 14, 2023
August 11, 2023	September 18, 2023	September 15, 2023 to October 12, 2023
September 8, 2023	October 16, 2023	October 13, 2023 to November 16, 2023
October 6, 2023	November 20, 2023	November 17, 2023 to December 14, 2023
November 10, 2023	December 18, 2023	December 15, 2023 to January 11, 2024
December 8, 2023	January 15, 2024	January 12, 2024 to February 15, 2024

Audience insights

Our audience insights provide information that can help you plan and analyze a marketing campaign.

We can help you:

- Profile (your database, your trade area, a customer address, a postal code list or geographical area)
- Determine market penetration
- Understand customer proximity to your store location
- Visualize your data on a map so you can explore marketing opportunities
- Measure campaign results

How can it help your marketing campaign?

Audience Insights can help you make decisions to plan an effective campaign and then analyze its performance.

Type and definition

Profile analysis

Understand the unique attributes of your customer profile analysis; features include:

- **Market demographic analysis** – find out who lives in and around your business for better targeting.
- **Customer demographic analysis** – tailor your message by audience life stage, lifestyle, ethnic origin, etc.

Response analysis

The response analysis report helps quantify the success of your marketing campaign and provides insight into the attributes that differentiate higher responding consumers (responders vs the target list).

Geolocation analysis

Profile visitors to your store using mobile traffic insights.

Foot traffic attribution

Provides insights into how your campaign has performed for a physical location.

Penetration analysis

Address to route: percentage of households that you have in a database file for each route.

Postal code to route: percentage of postal codes that you have in a database file for each route.

Proximity analysis

Identify how far customers are traveling to get to your store or physical location(s).

Visualize

See how your customer data intersects with store locations, previous campaign results and key audience characteristics to help refine your targeting strategy and maximize your direct mail results.



Smartmail Marketing Pricing

Our pricing is easier than you think – need more details on how it works.



Smartmail Marketing™

Pricing

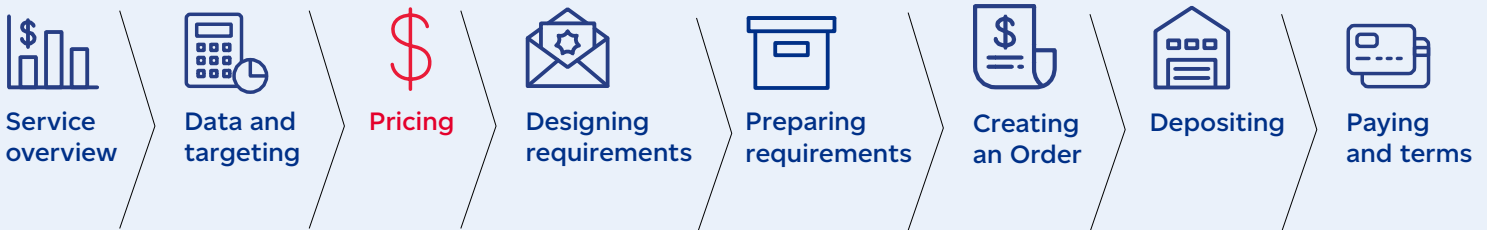

To access prices, you must meet all applicable requirements for the applicable service. Qualifying customers may have access to lower prices by signing an Agreement. All prices are subject to applicable rebates, discounts, fees, surcharges, adjustments and taxes.



Incentives

Qualifying customers may be offered discounts and/or rebates from time to time as part of promotional campaigns or in exchange for providing us with a testimonial about how our Smartmail Marketing services helped them meet their business goals.

Personalized Mail

Personalized Mail enhances one-to-one customer engagement to make the most of relationships driving greater loyalty and retention. Maximize relationships. Deepen connections. Get personalized.

For pricing information, visit canadapost.ca/notice.

Postal Code Targeting

Postal Code Targeting pairs targeting at the postal code level with customer suppression to efficiently optimize acquisition and promotion efforts. Effective costing. Efficient data. Surgically targeted.

For pricing information, visit canadapost.ca/notice.

Neighbourhood Mail

Neighbourhood Mail connects you to every home and apartment in specific neighbourhoods or regions anywhere across Canada. Hit everyone. Find customers. Reach wide.

For pricing information, visit canadapost.ca/notice.

PM = Personalized Mail

PCT = Postal Code Targeting

NM = Neighbourhood Mail

Service and description	PM	PCT	NM
<p>Phantom Pricing</p> <p>An amount of additional postage payable for the difference between the actual volume and the minimum volume of a mailing that does not meet the minimum volume requirement. The price charged will equal the lowest price in the category being accessed. Available for Personalized Mail and Postal Code Targeting.</p> <p>For example: 85 Machineable Mail items are deposited, when the minimum volume requirement is 100 mail items, so 15 mail items are subject to phantom pricing.</p> <p>Note: See the Personalized Mail and/or Postal Code Targeting price sheets for Special Handling phantom pricing.</p>	yes	yes	N/A
<p>Progressive Pricing</p> <p>Pricing process where the item is subject to a base price plus an additional per gram charge on each item that exceeds the base weight. Available for Personalized Mail, Postal Code Targeting and Neighbourhood Mail.</p>	yes	yes	yes
<p>Postal Indicia</p> <p>A postal indicia is a proof of payment and located in the postage zone on a mail item (download requirements, specifications and artwork from canadapost.ca/postal-indicia). Available for Personalized Mail and Postal Code Targeting.</p> <p>Postal indicia markings are not acceptable on Neighbourhood Mail items with the exception of the Business Reply Mail™ indicia and/or the “Basic Identifying Information” for Publications Mail™ items mailed as Neighbourhood Mail items.</p>	yes	yes	N/A
<p>Address Accuracy Program</p> <p>Address Accuracy is a program designed to improve delivery by encouraging you to accurately address mail. Each item must have a complete mailing address, including any required suite or unit information as well as the valid postal code for that address. Available for Personalized Mail.</p> <p>Participation in the Program is mandatory for all mailings greater than 5,000 items.</p> <p>If the percentage on the Statement of Accuracy (SOA) produced by Canada Post-recognized software is less than 95%, we will apply an adjustment to the mailing at the time the Order is transmitted electronically using EST or deposited at Canada Post.</p> <p>Address Accuracy adjustments are calculated as follows:</p> <p>Total volume x (95% – customer’s actual Address Accuracy %) x 5¢ = Total adjustment</p> <p>Failure to record the Address Accuracy percentage and expiry date on the Order will result in an adjustment to the cost of the mailing using the National Average Address Accuracy percentage of 56%. We encourage you to use our Data Management Services to clean and standardize your address lists while removing addresses that are undeliverable, duplicated, incorrect, or where occupants have requested to not be contacted. For more information visit canadapost.ca/datamanagementservices.</p>	yes	N/A	N/A

™ Trademarks of Canada Post Corporation.



Adjustments and surcharges

As per the terms and conditions, [Section 11 “Criteria for Qualification”](#), items presented to Canada Post for mailing may be verified to determine compliance with applicable terms and conditions. Items determined to have anomalies that may result in additional handling or expense to Canada Post or that may affect our quality of service may, at the discretion of Canada Post, be:

- returned at the customer’s expense, to be reworked by the customer, where possible
- processed and charged at the next or most appropriate Product or Service category, where available
- subjected to a surcharge; or
- refused for mailing.

The following provides detailed information on the adjustments and surcharges that may apply to your mailings if service requirements are not met.

Adjustments

Adjustments will apply in situations where inaccuracies are noted on an Order or during processing such as:

- errors in volume, weight, or service type selected
- failure to use the Electronic Shipping Tools (EST) software when mandatory for the declared service, or
- Address Accuracy requirements are not met.

Surcharges

“Item” level surcharge

Surcharge applied to all items in a given mailing when mandatory requirements are not met. In the case of multiple mailing anomalies, only one item level surcharge will be applied.

“Order” level surcharge

Surcharge applied when orders are not transmitted prior to deposit of mailing.

Note: Surcharges are applied to each requirement not met per service category based on the “actual” versus “declared” indicated on the Order and are invoiced with same method of payment as per the original Order. Item level surcharges under \$100 will automatically be applied at time of deposit.

5¢ Non-compliance item level surcharge

PM = Personalized Mail PCT = Postal Code Targeting

Invoice Description	Description Details	PM	PCT
2D barcode incorrect match	2D barcode information doesn't match Presort Mailing Plan	yes	yes
Address elements/format issues	Address elements or format did not meet the addressing requirements	yes	yes
Address labels not secured	Labels used for address are not secured to the mail item	yes	yes
Address slips from window	Content slipped within the window of the envelope making the address not possible to read	yes	yes
Brick-piling issues	Brick-piling specifications have not been met	yes	yes
Bundle labelling issues	Bundles have been incorrectly labelled	yes	yes
Bundle separation issues	The method used for separating the bundles (i.e., separator cards, edgemarking) does not meet the specifications	yes	yes
Bundle sequencing issues	Bundles have been incorrectly sequenced within a container	yes	yes
CDN Return Address issues	Canadian Return Address is not correct, is missing or is misplaced	yes	N/A
Container labels incorrect	Container labels do not match the content of the container	yes	yes
Container labels missing	Container labels are missing on one or more container	yes	yes
DMC code issues	Delivery Mode Code did not meet the standard for formatting and location, or is not valid, or is not visible	yes	yes
Enclosure non-compliance	Enclosures or inserts do not meet the specifications	yes	yes
Items improperly sealed	Mail items not properly sealed or unwrapped items are not properly sealed to support processing	yes	yes
Items sticking together	Mail items sticking together	yes	yes
Mail sequencing issues	Mail sequencing specifications not met	yes	yes
Minimum item size not met	Mail item minimum size requirement not met	yes	yes
Minimum item weight not met	Mail item minimum weight requirement not met	yes	yes
Mono/Pallet labels incorrect	Monotainer/pallet labels do not match the content of the container, are missing information or contain incorrect information	yes	yes
Mono/Pallet missing label	Monotainers/pallets labels are missing on one or more shipping unit	yes	yes
Pallet size/wrap issues	Issues with the pallet size or pallet wrapping	yes	yes
Plastic wrapper issues	Wrapper exceeds contents by more than allowable distance as per specs	yes	N/A
Product shape non-compliance	Shape of the mail item does not meet specifications	yes	yes
Quiet zone around add block	Quiet zone around the address block has been compromised	yes	yes
Strapping issues	Strapping used to secure the bundles is non-compliant	yes	yes

Order level surcharge (\$45.00)

PM = Personalized Mail

PCT = Postal Code Targeting

NM = Neighbourhood Mail

Invoice description	Description details	PM	PCT	NM
Non-transmitted Order surcharge	Order not transmitted prior to deposit of mailing	yes	yes	yes

The classification and amount of surcharge can change at any time immediately upon notice to you. This list is not meant to be exhaustive.





Smartmail Marketing Designing requirements

Design a connected customer
experience



Smartmail Marketing™

Designing requirements

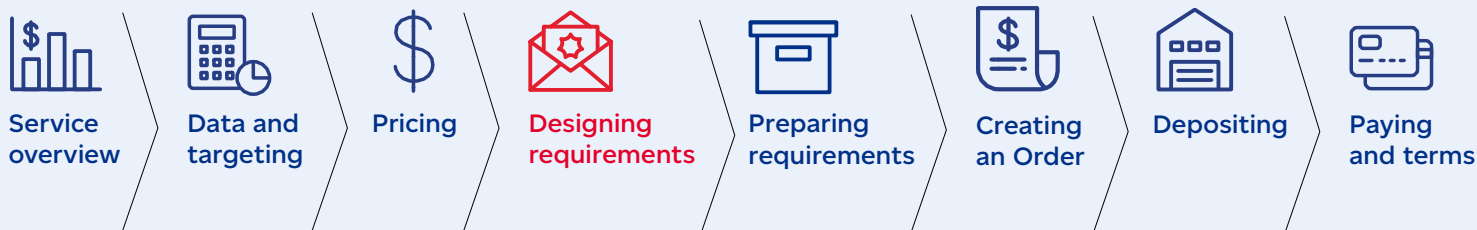

Designing Machineable Mail – Standard items

Mandatory requirements

Standard Items*	Length	Width	Thickness	Aspect Ratio (L/W)	Weight
Minimum	140 mm (5.6 in.)	90 mm (3.6 in.)	0.18 mm (0.007 in.)	1.3:1	2 g (0.07 oz.)
Maximum	245 mm (9.6 in.)	156 mm (6.1 in.)	5 mm (0.2 in.)	2.6:1	50 g (1.76 oz.)

*Square envelopes are acceptable, minimum 140 mm x 140 mm x 0.18 mm (5.5 in. x 5.5 in. x 0.007 in.) and maximum 156 mm x 156 mm x 5 mm (6.14 in. x 6.14 in. x 0.2 in.).

Note: Personalized Mail items within a given mailing can have different sizes, weights and thicknesses provided the items remain in the same weight category. Each item within a mailing must originate from the same mailer.

Machineability

Shape

Rectangular (square envelopes are acceptable).

Material

- Must be paper; items cannot be made or wrapped in plastic.
- Minimum paper weight for:
 - envelope: 75 gsm (approx. 20 lb. bond)
 - folded self-mailer: minimum 90 gsm (approx. 60 lb. text)
 - cards: minimum 160 gsm (approx. 60 lb. cover)
- Must be sufficiently flexible to bend; items cannot be rigid.

Enclosures

- Any paper enclosure is acceptable.
- Flexible magnets, single coin, key tags and plastic cards are acceptable when firmly attached.
- Liquids, powders and gels are unacceptable unless tested and approved by Canada Post prior to deposit.

Sealing (see [illustrated examples](#))

Envelopes: Must be closed and sealed with adhesive, with no more than 35 mm of the flap unsealed on each item.

Self-mailers: Must have the fold or continuous seal along the bottom edge.

Creative features

Items with the following features must be tested and approved by us prior to deposit:

- alternative sealing locations
- die-cuts placed along the top, leading or trailing edge
- zipper seals/perforations on the exterior items
- decorative and creative font
- non-paper enclosures within a self-mailer
- square self-mailers and cards
- tip-on placed on a card.

For Postal Code Targeting only:

- quiet zones contain text, graphics or dark colours.

Once tested and approved, the service ticket # must be written on the Order at the time of deposit ([Assess your Machineable Standard or Oversize mail items](#)).

Readability

Item readability	Personalized Mail	Postal Code Targeting
Postage zone (see postal indicia)	<p>The indicia must be placed on the front of the item (same side as the destination address).</p> <p>The top-right area is reserved for postage, measuring a width of 74 mm (2.9 in.) and a height of 35 mm (1.4 in.).</p> <p>The top-right area is reserved for postage meters, measuring a width of 100 mm (3.4 in.) and a height of 35 mm (1.4 in.).</p> <p>If the indicia is placed outside the postage zone it must be located above and to the right of the address.</p>	<p>The indicia must be placed on the front of the item.</p> <p>The top-right area is reserved for postage, measuring a width of 74 mm (2.9 in.) and a height of 35 mm (1.4 in.).</p>

Item readability	Personalized Mail	Postal Code Targeting
<p>Addressing</p>	<p>Each item must bear a complete address which includes an individual, company or non-personalized descriptor (e.g., “OCCUPANT”), street address, municipality, province and a valid postal code.</p> <p>Address zone Whether vertically or horizontally oriented, the complete address must appear inside the following area:</p> <ul style="list-style-type: none"> • 35 mm from the top. • 10 mm from the bottom, left and right edges. <p>Address labels and windows must be within the address zone.</p> <p>Quiet zone</p> <ul style="list-style-type: none"> • Around the address block, leave at least 5 mm clear of text, graphics and dark colours. • For window envelopes, ensure that the entire address remains fully visible through the window, even if the enclosure shifts within the envelope. 	<p>The destination address cannot include an individual, company or personalized descriptor. Each item must bear a complete non-personalized address which includes a street address, municipality, province and a valid postal code placed on two lines.</p> <p>Address zone Whether vertically or horizontally oriented, the complete non-personalized address must appear inside the following area:</p> <p>On the front of the item:</p> <ul style="list-style-type: none"> • the background must be clear of text, graphics and dark colours. <ul style="list-style-type: none"> – Horizontal – Must measure 120 mm long (from the bottom right edge) and 45 mm high. – Vertical – Must measure 45 mm long (from the bottom left edge) and 120 mm high. <p>Address labels and windows must be within the address zone.</p> <p>Quiet zone</p> <ul style="list-style-type: none"> • Around the address block, leave at least 5 mm clear of text, graphics and dark colours. • For window envelopes, ensure that the entire address remains fully visible through the window, even if the enclosure shifts within the envelope. <p>On the back of the item:</p> <ul style="list-style-type: none"> • the background must be clear of text, graphics and dark colours: <ul style="list-style-type: none"> – Horizontal – Must measure 140 mm long (from the bottom left edge) and 15 mm (0.6 in.) high. – Vertical – Must measure 15 mm (0.6 in.) long (from the bottom right edge, leading edge) and 140 mm (5.5 in.) high.
<p>Return address zone</p>	<ul style="list-style-type: none"> • The preferred location is on the front of the item above the address zone (35 mm from the top). • Must be the same orientation as the destination address. • A minimum vertical separation of 15 mm (0.6 in.) is required between the bottom of the return address and the top of the destination address. 	<p>If the creative includes an address (store location, etc.) in order to not be confused with a delivery address, options may include removing the province and/or postal code or placing the address elements on the same line.</p>

Item readability	Personalized Mail	Postal Code Targeting
Address fonts	<p>Commercially available fonts should be easy to read, have well-defined characters and:</p> <ul style="list-style-type: none"> • Not overlap to the line above or below. • Not contain text effects (i.e., shadow, emboss, etc.). • Not contain random heights within characters. • Not include calligraphy styles (i.e., <i>the quick brown fox jumps over the lazy dog</i>). <p>Fonts must be a dark colour (preferably black). There should be good contrast between address and background.</p>	Same as for Personalized Mail.
2D barcode requirements	The 2D barcoded postal indicia requirements can be found at canadapost.ca/postal-indicia .	Same as for Personalized Mail.

Failure to meet these mandatory requirements may result in mail delays or surcharges. Not all creative designs and sealing options are mentioned above, assessment of your physical mail item is recommended.

Additional requirements

Scented or allergen items

Ensure each item is mailable and consider the following:

- Scented items must be sealed in such a manner that prevents the scent from escaping. Similarly, liquids and powders must be packaged appropriately. A scented item produced using micro-encapsulated scent infused ink/lacquers does not need to be sealed provided the scented area is covered or contained within the mailed item.
- If an item contains a common allergen such as peanuts, sesame seeds, tree nuts (e.g., almonds, walnuts) or eggs, it must be packaged and labelled to minimize the potential for allergic reactions.

Promoting cannabis, accessories (including vaping products)

Ensure the design and content of your item is mailable, meets the requirements outlined in the [Cannabis Act](#) and adheres to the federal, provincial and territorial regulations. Detailed information can be found in [Promotion of cannabis](#) – ABCs of mailing of the *Canada Postal Guide*.



Illustrated examples – Standard Machineable Mail

Templates to help you design envelopes, self-mailers and cards are available in our [Machineable Mail Advisor tool](#).

Personalized Mail

1 Postage zone

Measures from the upper right corner 74 mm (2.9 in.) wide (100 mm width for postage meters) by 35 mm (1.4 in.) high. The indicia must be placed on the same side as the destination address (the front).

2 Return address

The preferred return address location is on the front of the item. Measured from the upper left corner of the envelope. A minimum of 15 mm (0.6 in.) between the bottom of the return address and the top of the destination address is required.

Horizontal orientation

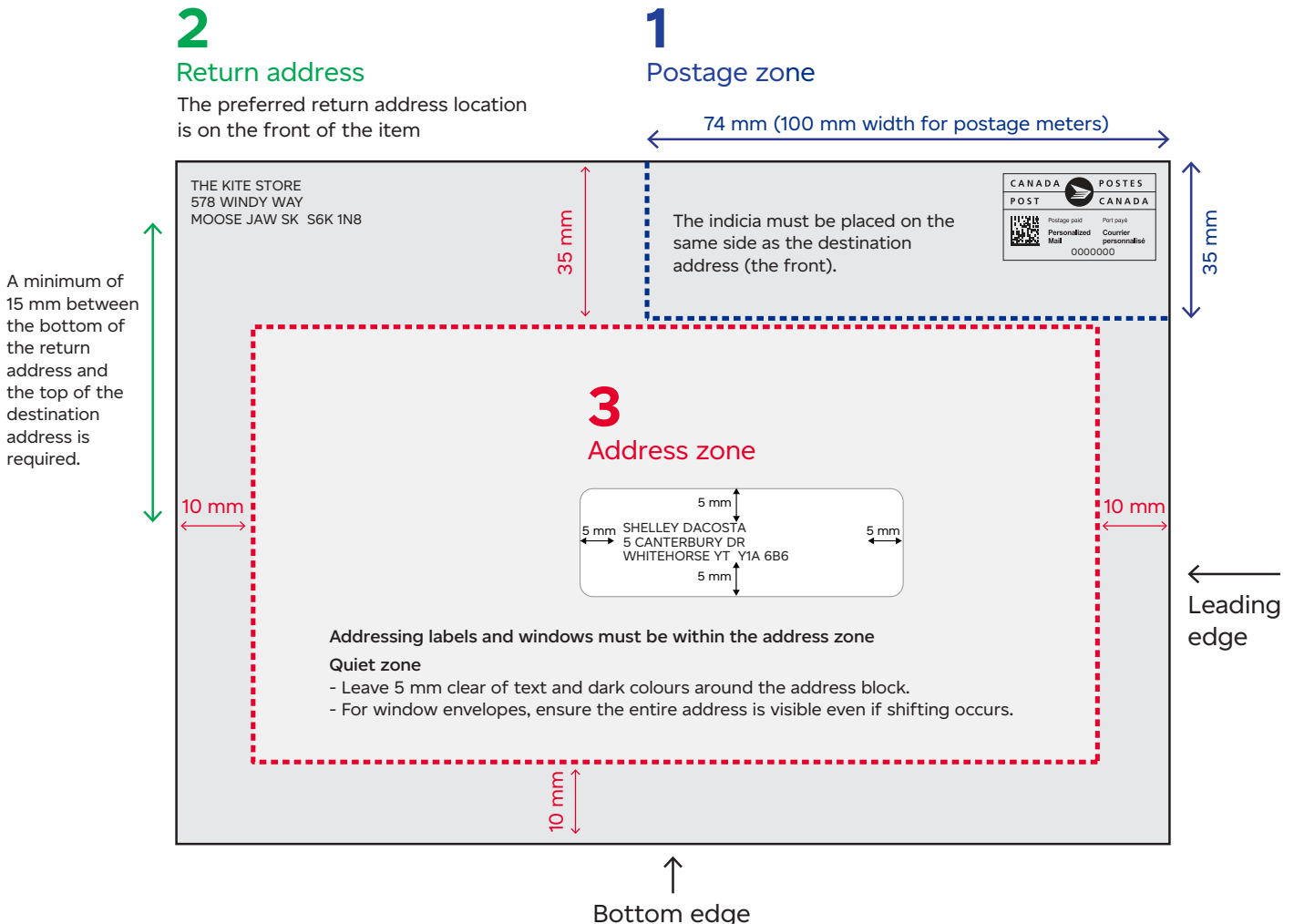

3 Address zone

Must be 10 mm (0.4 in.) from the left, right and bottom edges of the envelope, and 35 mm (1.4 in.) from the top. Addressing labels and windows must be within the address zone.

For the Quiet zone (areas you must leave clear of printing, images, and dark colours):

- Leave 5 mm (0.2 in.) clear of text and dark colours around the address block.
- For window envelopes, ensure the entire address is visible even if shifting occurs.

Whether horizontally or vertically oriented, the addressing requirements are the same.

Images are for illustration purposes only.

Vertical orientation

2
Return address

1
Postage zone

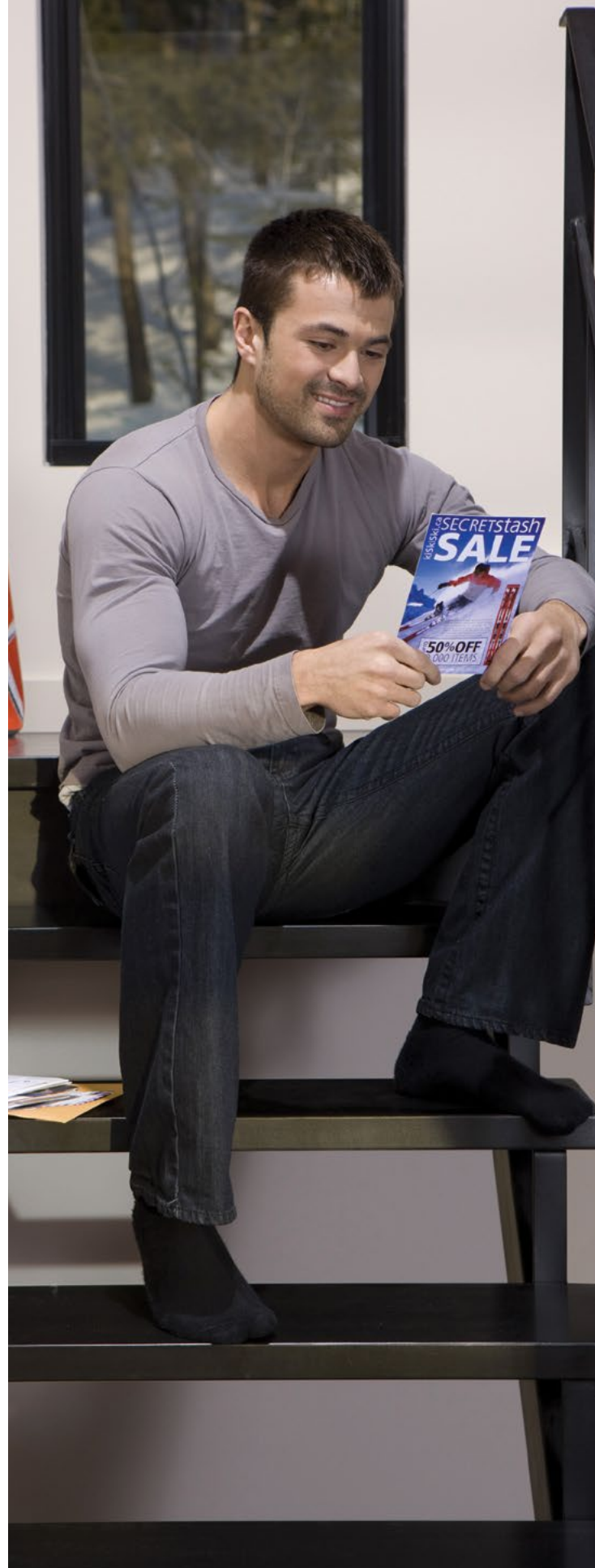
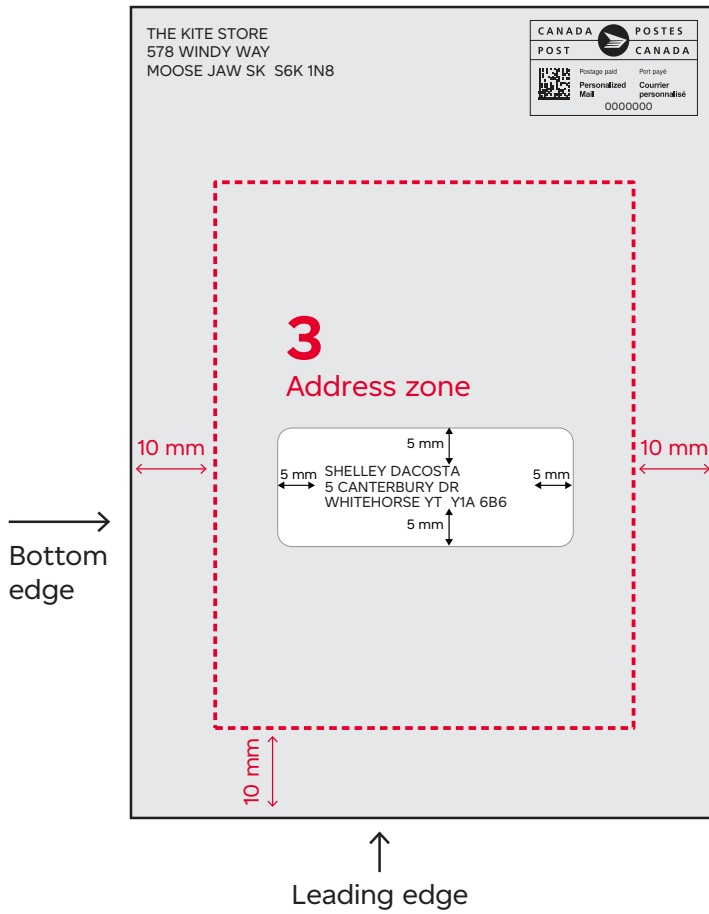

Illustrated example – Postal Code Targeting

Horizontal front orientation

1 Postage zone

Measures from the upper right corner 74 mm (2.9 in.) wide by 35 mm (1.4 in.) high.

2 Address zone

Measured from the bottom right corner of the piece. Must be located 120 mm (4.75 in.) from the leading edge and 45 mm (1.8 in.) from the bottom edge of the piece. Leave 10 mm (0.4 in.) clear from the leading and bottom edges of the piece. Leave 5 mm (0.2 in.) clear of text and dark colours around the address block.

Images are for illustration purposes only.

Horizontal front orientation

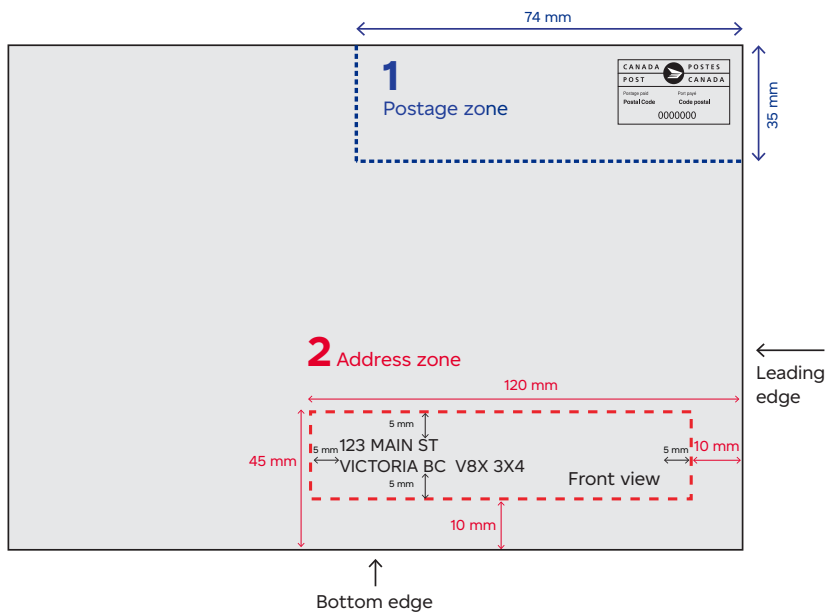

Horizontal back orientation

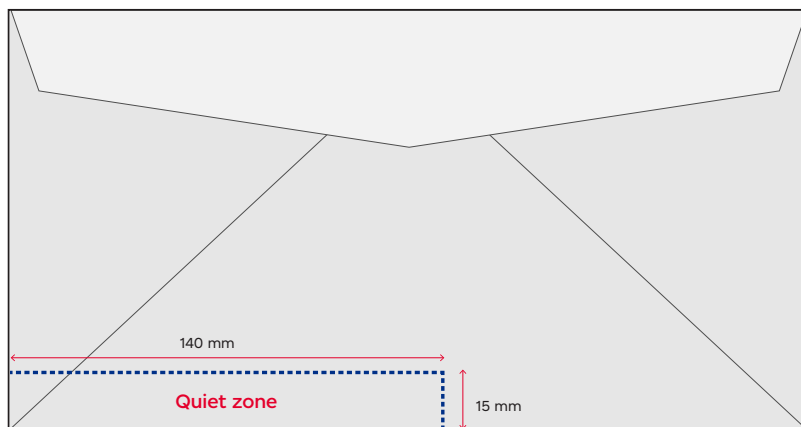

Quiet zone measures 15 mm (0.6 in.) from the leading edge and 140 mm (5.5 in.) from the leading edge.

Vertical front orientation

1 Postage zone

Measures from the upper right corner 74 mm (2.9 in.) wide (100 mm width for postage meters) by 35 mm (1.4 in.) high.

2 Address zone

Measured from the bottom edge of the piece. Must be located 120 mm (4.75 in.) from the leading edge and 45 mm (1.8 in.) from the bottom edge of the piece. Leave 10 mm clear from the leading and bottom edges of the piece. Leave 5 mm (0.2 in.) clear of text and dark colours around the address block.

Vertical front orientation

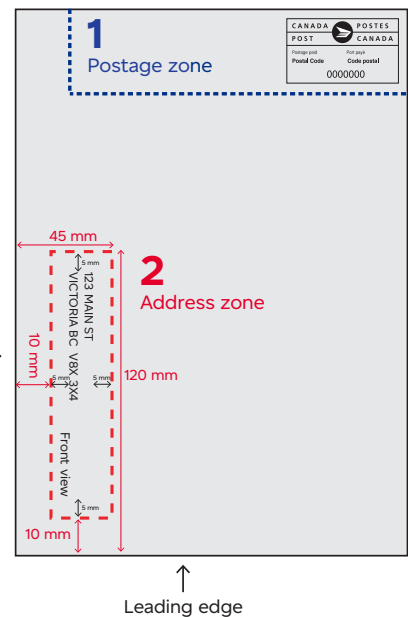

Vertical back orientation

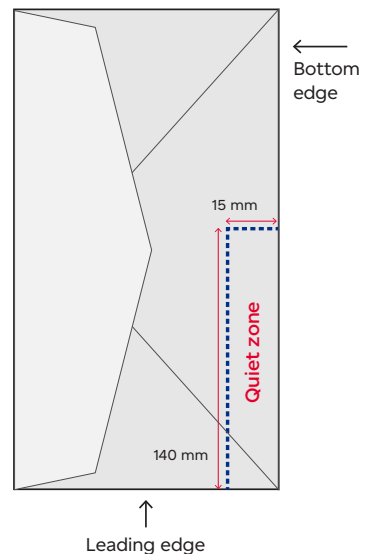

Horizontal front view with back quiet zone perspective

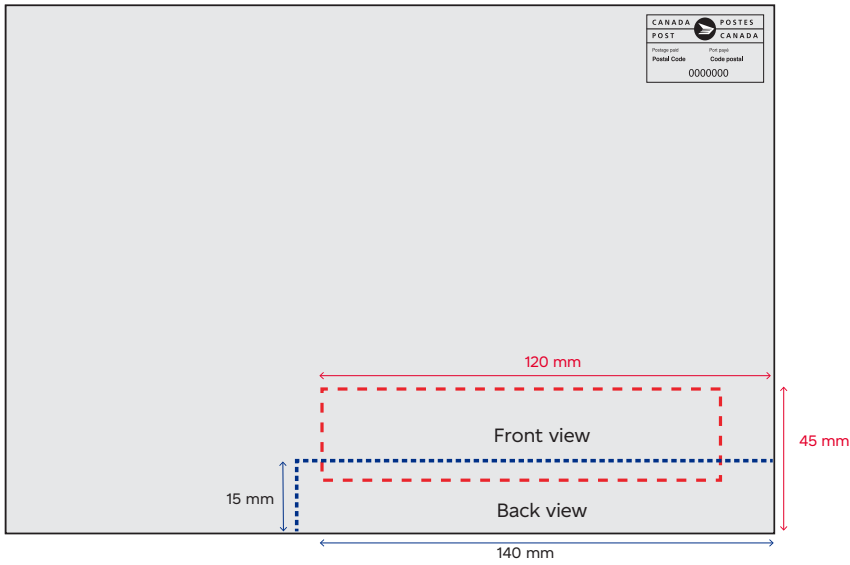

Vertical front view with back quiet zone perspective

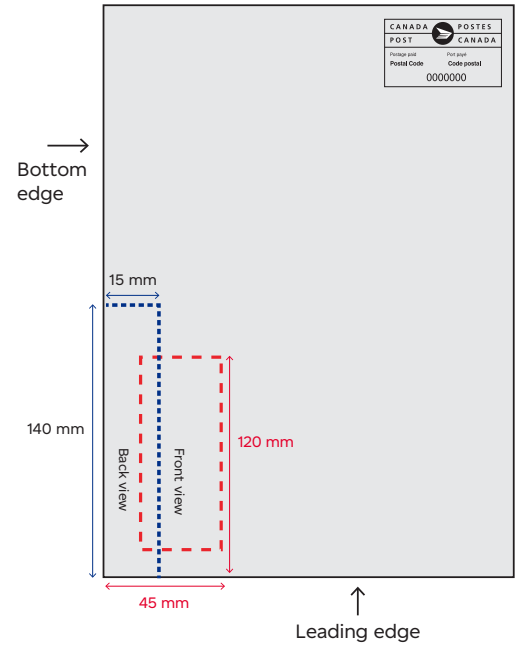

Acceptable sealing location

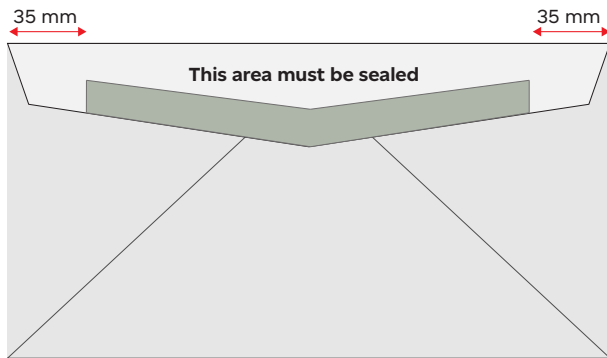

Envelopes must be closed and sealed with adhesive, with no more than 35 mm (1.4 in.) of the flap unsealed on each end.

To prevent envelopes from sticking together, do not apply an excessive amount of adhesive. Envelopes must not be sealed with staples, clasps or other similar devices.

Images are illustrations of acceptable sealing options.

Single sheet self-mailer

- Are formed by a single sheet of paper, folded once or multiple times into panels.
- Must have the fold or continuous seal along the bottom edge plus a clip/spot seal on top.

Images are illustrations of acceptable sealing options.

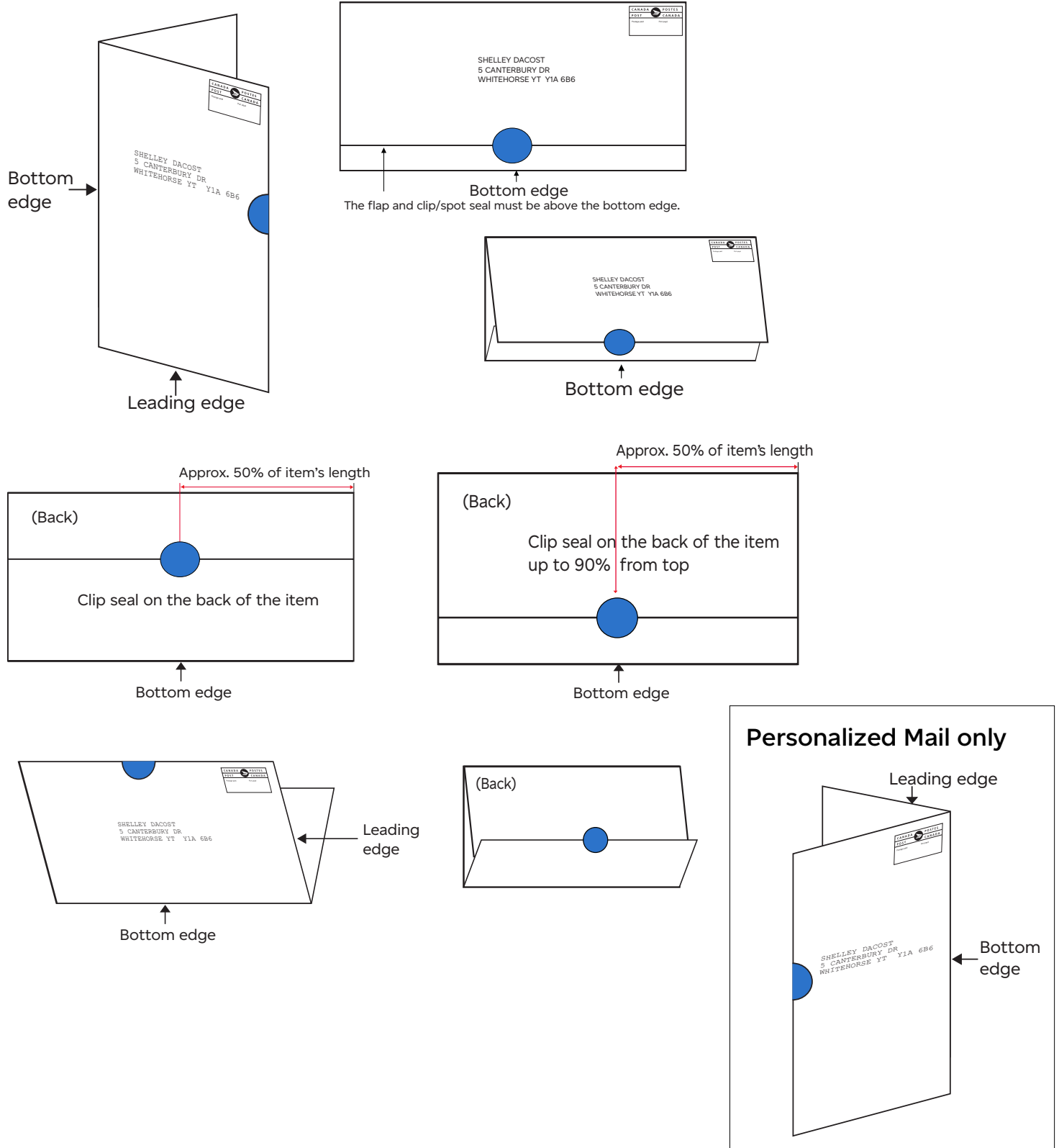

Multiple sheet self-mailer/Mini-catalogue

- Contain multiple sheets of paper, folded once or multiple times into panels and are bound/stitched together.
- Must have the fold or continuous seal along the bottom edge and either:
 - a clip/spot seal on top and leading edge; or
 - two clip/spot seals on the leading edge.

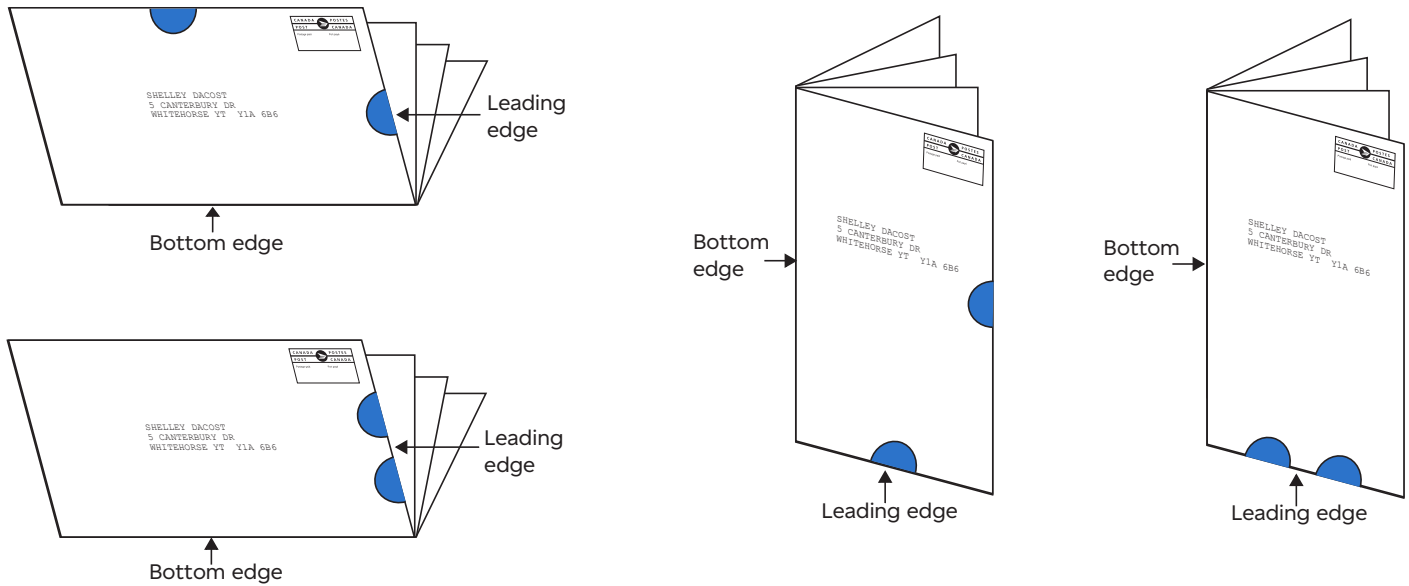

Designing Machineable Mail – Oversize items

Mandatory requirements – For Personalized Mail items only

Oversize Items	Length	Width	Thickness	Weight
Minimum	140 mm (5.6 in.)	90 mm (3.6 in.)	0.5 mm (0.02 in.)	10 g (0.4 oz.)
Maximum	380 mm (14.9 in.)	270 mm (10.6 in.)	20 mm (0.8 in.)	500 g (17.6 oz.)

Note: Personalized Mail items within a given mailing can have different sizes, weights and thicknesses provided the items remain in the same weight category. Each item within a mailing must originate from the same mailer.

Machineability

Shape

Must be rectangular or square

Material

- Must be paper or plastic
- Minimum paper weight for:
 - envelope: 90 gsm (approx. 60 lb. text)
 - folded self-mailer: 90 gsm (approx. 60 lb. text)
 - card and postcard: 160 gsm (approx. 60 lb. cover)
- Minimum plastic requirements (wrapper):
 - covered with transparent or opaque material (max. haze of 75%, 159 gloss unit or less)
 - must be at least 0.03 mm (0.001 in.) thick and be low-slip coated.
- Items can be packaged in flexible or rigid material
- Items must remain horizontal when held by the edge in one hand
- Unwrapped item cover pages are strong enough to withstand machine processing without damage (at least twice as thick as the inside pages).

Enclosures

- Any paper enclosure is acceptable.
- Flexible magnets, single coin, key tags and plastic cards are acceptable when firmly attached.
- Liquids, powders and gels are unacceptable unless tested and approved by Canada Post prior to deposit.
- Enclosures within a wrapper/envelope, must closely fit the outer wrapper/envelope.

Sealing

Envelopes and wrapped items must be closed and sealed with adhesive, with no more than 35 mm of the flap unsealed on each end. To prevent items from sticking together, do not apply an excessive amount of adhesive. Envelopes must not be sealed with staples, clasps or other similar devices.

Creative features

Items with the following features must be tested and approved by us prior to deposit:

- alternative sealing locations
- tip-on placed on a card
- zipper seals/perforations on the exterior items
- die-cuts placed along the top, leading or trailing edge
- non-paper enclosures within a self-mailer
- decorative and creative font

Once tested and approved, the service ticket # must be written on the Order at the time of deposit.

Readability

Addressing

Each item must bear a complete address which includes an individual, company or non-personalized descriptor (e.g., "OCCUPANT"), a street address, municipality, province and a valid postal code.

Address zone

Whether vertically or horizontally oriented, the complete address must appear inside the following area:

- 10 mm (0.4 in.) from the bottom, left and right edges;
- for **horizontal address orientation**, one-quarter of the items height measured from the top edge down;
- for **vertical address orientation**, one-fifth of the items length measured from the edge above the address down.

Address labels and windows must be within the address zone.

Quiet zone

- Clear of text, graphics and dark colours, above the top line of the address block, leave at least 6 mm (0.24 in.); 10 mm (0.4 in.) to the left, right and below of the address block.
- For window envelopes, ensure that the entire address remains fully visible through the window, even if the enclosure shifts within the envelope.

Postage zone

- The top-right area is reserved for postage, measuring a width of 74 mm (2.9 in.) and a height of 35 mm (1.4 in.).
- The indicia must be placed on the front of the item (same side as the destination address).
- If the indicia is placed outside the postage zone it must be located above and to the right of the address.

Return address zone

- The preferred location is on the front of the item above the address zone (one-quarter [horizontal]/one-fifth [vertical] from the top).
- Must be the same orientation as the destination address.
- A minimum vertical separation of 18 mm (0.71 in.) is required between the bottom of the return address and the top of the destination address.

Address fonts

Commercially available fonts should be easy to read, have well-defined characters and:

- Not overlap to the line above or below
- Not contain text effects (i.e., shadow, emboss, etc.)
- Not contain random heights within characters
- Not include calligraphy styles (i.e., *the quick brown fox jumps over the lazy dog*).

Fonts must be a dark colour (preferably black). There should be good contrast between address and background.

Failure to meet these mandatory requirements may result in mail delays or surcharges. Not all creative designs and sealing options are mentioned above, assessment of your physical mail item is recommended ([Assess your Machineable Standard or Oversize mail items](#)).

Additional requirements

Scented or allergen items

Ensure each item is mailable and consider the following:

- Scented items must be sealed in such a manner that prevents the scent from escaping. Similarly, liquids and powders must be packaged appropriately. A scented item produced using micro-encapsulated scent infused ink/lacquers does not need to be sealed provided the scented area is covered or contained within the mailed item.
- If an item contains a common allergen such as peanuts, sesame seeds, tree nuts (e.g., almonds, walnuts) or eggs, it must be packaged and labelled to minimize the potential for allergic reactions.

Promoting cannabis, accessories (including vaping products)

Ensure the design and content of your item is mailable, meets the requirements outlined in the [Cannabis Act](#) and adheres to the federal, provincial and territorial regulations. Detailed information can be found in [Promotion of cannabis](#) – ABCs of mailing of the *Canada Postal Guide*.

Illustrated example – Oversize Machineable Mail

Templates to help you design envelopes, self-mailers and cards are available in our [Machineable Mail Advisor](#) tool.

1 Postage zone

Measures from the upper right corner 74 mm (2.9 in.) wide by 35 mm (1.4 in.) high. The indicia must be placed on the same side as the destination address (the front).

2 Return address

The preferred return address location is on the front of the item (1/4 horizontal or 25% of total width) in the top left corner. A minimum of 18 mm (0.71 in.) between the bottom of the return address and the top of the destination address is required.

3 Address zone

Address zone for horizontal orientation, must be 10 mm from the left, right, bottom edges of the envelope, and 1/4 or 25% from the top.

For vertical orientation the zone is 10 mm (0.4 in.) from the left, right, bottom edges of the envelope, and from the top, 1/5 or 20% of total height.

Addressing labels and windows must be within the address zone. For the address label, leave 6 mm (0.24 in.) from the top and 10 mm to the left, right and below clear of print and dark colours around the address block. For window envelopes, ensure the entire address is visible even if shifting occurs.

Images are for illustration purposes only.

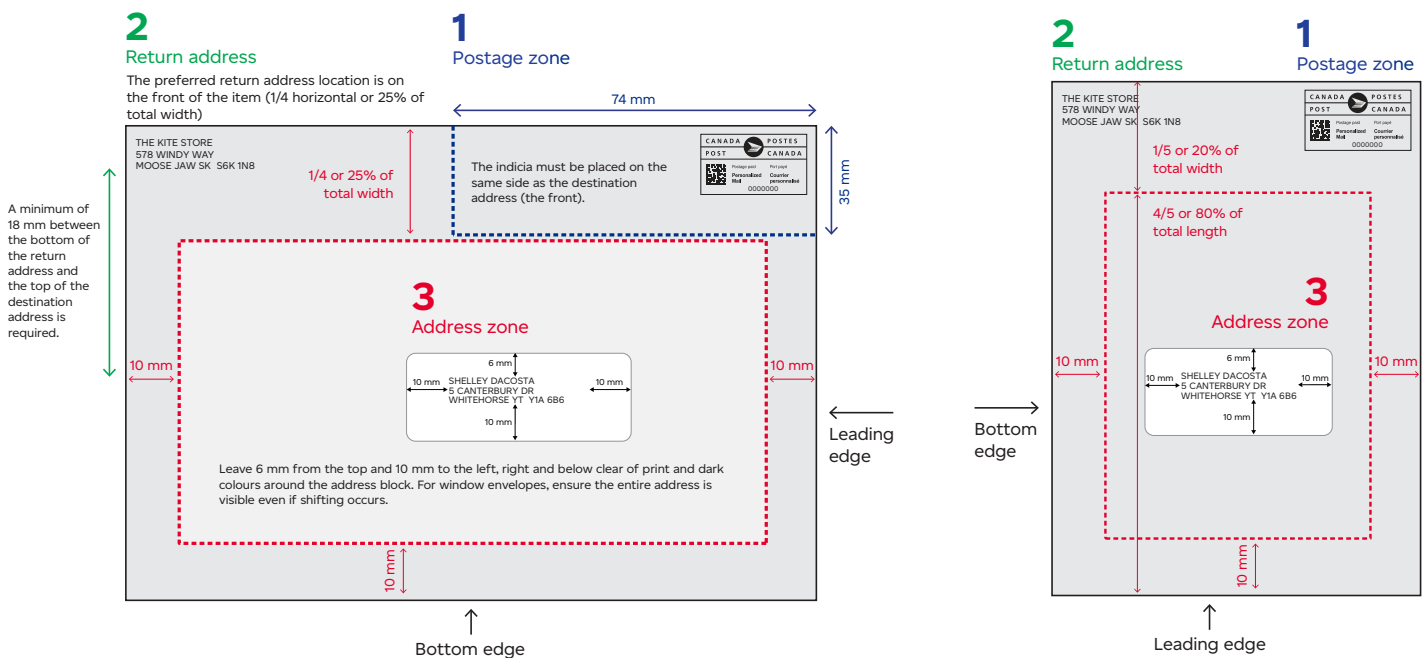

Assess your Machineable Standard or Oversize mail items

Assess your mail items before mailing

To ensure that your **Personalized Mail** or **Postal Code Targeting** mailing can be processed on our machines and that your mail items meet the requirements for Machineable Mail, we offer free evaluation services. You have several assessment options.

Standard self-assessment tool

Complete your own self-assessment by using our “Standard Self-Assessment Tool”:

- Postal Code Targeting: [Postal Code Targeting – Self-assessment tool](#)
 - Personalized Mail: [Machineable Mail – Self-assessment tool](#).
-

Electronic sample evaluation

Contact a Commercial Service Network (CSN) representative at 1-866-757-5480 to provide an electronic sample (PDF format) of your mail item. The electronic sample must clearly show how the item will be constructed, and include:

- finished item size (e.g., length, width, thickness and approximate weight)
- paper basis weight
- fold locations (self-mailers)
- sealing location and sealing method (self-mailers and envelopes)
- window location (if applicable) and address location.

Our CSN representative may request additional testing if the electronic sample does not provide enough information. Physical approval testing is required when Creative Features are used (see the Mandatory Requirements section for details).

Additionally, for Postal Code Targeting items:

- quiet zones (front and back).
-

Physical approval testing

Customers requiring a physical test of their mail items on our mail processing equipment must send 200 samples of the final version of the mailing by calling a CSN representative at 1-866-757-5480 to obtain a service ticket number and the address to send your samples to. This process is optional, unless your mail item utilizes Creative Features defined in the Mandatory Requirements section.

1. To test readability:

- Personalized Mail items must be addressed
- Postal Code Targeting items must be addressed with a non-personalized address.

2. You can use the same address on all items. Any valid Canadian address is acceptable.

When 200 samples are not available for physical testing, the Mail Standards and Testing team can provide feedback on a to-scale mock-up (prototype). To have your prototype evaluated, contact the CSN at 1-866-757-5480.

Note: We cannot provide approval on a prototype. This service is meant to provide feedback on designs prior to producing 200 items for physical testing.

Designing Special Handling mail

Mandatory requirements – Personalized Mail and Postal Code Targeting items only

Category	Size	Length	Width	Thickness	Weight
Standard	Minimum	100 mm (3.9 in.)	70 mm (2.8 in.)	0.18 mm (0.007 in.)	N/A
	Maximum	245 mm (9.6 in.)	156 mm (6.1 in.)	5 mm (0.2 in.)	100 g (3.5 oz.)
Oversize	Minimum	100 mm (3.9 in.)	70 mm (2.8 in.)	0.18 mm (0.007 in.)	N/A
	Maximum (flexible)	380 mm (14.9 in.)	380 mm (14.9 in.)	35 mm (1.4 in.)	1.36 kg (3 lb.)
	Maximum (rigid)	380 mm (14.9 in.)	130 mm (5.1 in.)	35 mm (1.4 in.)	1.36 kg (3 lb.)
Dimensional (Personalized Mail only)	Minimum	100 mm (3.9 in.)	70 mm (2.8 in.)	35 mm (1.4 in.)	N/A
	Maximum	380 mm (14.9 in.)	130 mm (5.1 in.)	60 mm (2.4 in.)	1.36 kg (3 lb.)

Requirements

Shape

Any, including odd shapes.

Material

Minimum paper weight for:

- envelope and self-mailer: 60 gsm (approx. 16 lb.)
- card and postcard: 135 gsm (approx. 50 lb.)

Any paper type may be used for the outer covering of the mail item. The following are examples:

- coated paper
- paper containing:
 - raised or special effect printing
 - background patterns or watermarks
 - bright colours.

Transparent wrapping (recommended thickness):

- Plastic bag – at least 0.05 mm
- Plastic film – at least 0.02 mm
- Oversized items exceeding 380 mm x 130 mm in size should be flexible in order to fit into mail receptacles.

Enclosures

For efficient handling and processing, ensure that enclosures:

- cannot damage other mail or cause injury to postal employees (magnets, for example, must not be so strong that they cause mail items to stick to each other),
- won't tear through their envelope or wrapping during handling and delivery,
- allow efficient mail preparation, such as grouping and containerization,
- do not bear postal indicia or second destination address for another product that is visible on the outside of the mail item.

Note: In order to confirm that an enclosure is an integral part of your unwrapped mail item a “pinch test” must be performed. Place the middle of the item's fold (or spine) in the palm of your hand, between your thumb and fingers. Grasp the item tightly, and shake it back and forth (horizontally) with its open end facing downward.

Addressing

The Delivery Mode Code (DMC) must be included in the address to qualify for the Special Handling option. Requirements are listed in the “Preparing Requirements” section.

Address zone

Personalized Mail

Each item must bear a complete address which includes an individual, company or non-personalized descriptor (e.g., “OCCUPANT”), a street address, municipality, province and a valid postal code.

Whether vertically or horizontally oriented, the complete address must appear inside the following area:

- at least 10 mm (0.4 in.) from all the edges of the mail item
- on the same side as the indicia
- to the right and below the return address when a return address is used
- to the left of the indicia and NOT above it
- at least 10 mm (0.4 in.) from the indicia.
- outside the recommended return address zone when there is no return address

Postal Code Targeting

The destination address cannot include an individual, company or personalized descriptor. Each item must bear a complete non-personalized address which includes a street address, municipality, province and a valid postal code placed on two lines. Whether vertically or horizontally oriented, the complete non-personalized address must appear inside the following area:

- Horizontal – must measure 120 mm (4.7 in.) long (from the bottom right edge) and 45 mm (1.7 in.) high:
 - on the same side as the indicia
 - to the left of the indicia and NOT above it
- Vertical – must measure 45 mm (1.7 in.) long (from the bottom left edge) and 120 mm (4.7 in.) high:
 - At least 10 mm (0.4 in.) from the indicia
 - No return address

On wrapped or unwrapped items

Ensure that the destination address is completely visible and it must appear on or in the transparent wrapper, on the sleeve or on the insert and be located at least 10 mm from all edges.

Magazines

The destination address may be positioned parallel (horizontal address orientation) or perpendicular (vertical address orientation) to the longest edge of the magazine.

Postage zone

The indicia may be placed anywhere on the front of the item provided that it can easily be identified, to the right of the destination address and NOT below it and at least 10 mm (0.4 in.) from the destination address.

Return address zone (Personalized Mail only)

The return address, if present, must be the same orientation as the destination address and clearly visible on or through the wrapper. It may appear on either the front (the address side) or the back of the item.

Non-paper enclosures (examples, list is not exhaustive)

- CDs and DVDs
- coins
- magnets
- foodstuffs/product samples
- pens and pencils
- jewellery
- keys
- plastic cards
- seeds
- video-in-print/digital advertising



Illustrated example – Personalized Mail

1 Postage zone

Measures from the upper right corner 74 mm (2.9 in.) wide (100 mm width for postage meters) by 35 mm (1.4 in.) high. The indicia must be placed on the same side as the destination address (the front).

2 Return address

Return address may be printed either on the front or back of the item. On front: with 35 mm from top and 100 mm (3.4 in.) away from right edge, 74 mm (2.9 in.) (100 mm [3.4 in.] width for postage meters) either on the front or back of the item. On front: with 35 mm (1.4 in.) from top and 100 mm (3.4 in.) away from right edge.

3 Address zone

Address zone is at least 10 mm (0.4 in.) from all edges and 10 mm from the indicia. The destination address must be to the right and below the return address or to the left of the indicia and NOT above it.

Addressing labels and windows must be within the address zone. For the address label, leave 3 mm (0.12 in.) from the top, left, right and below clear of print and dark colours around the address block. For window envelopes, ensure the entire address is visible even if shifting occurs.

Images are for illustration purposes only.

2

Return address

Return address may be printed either on the front or back of the item. On front: with 35 mm from top and 100 mm away from right edge.

1

Postage zone

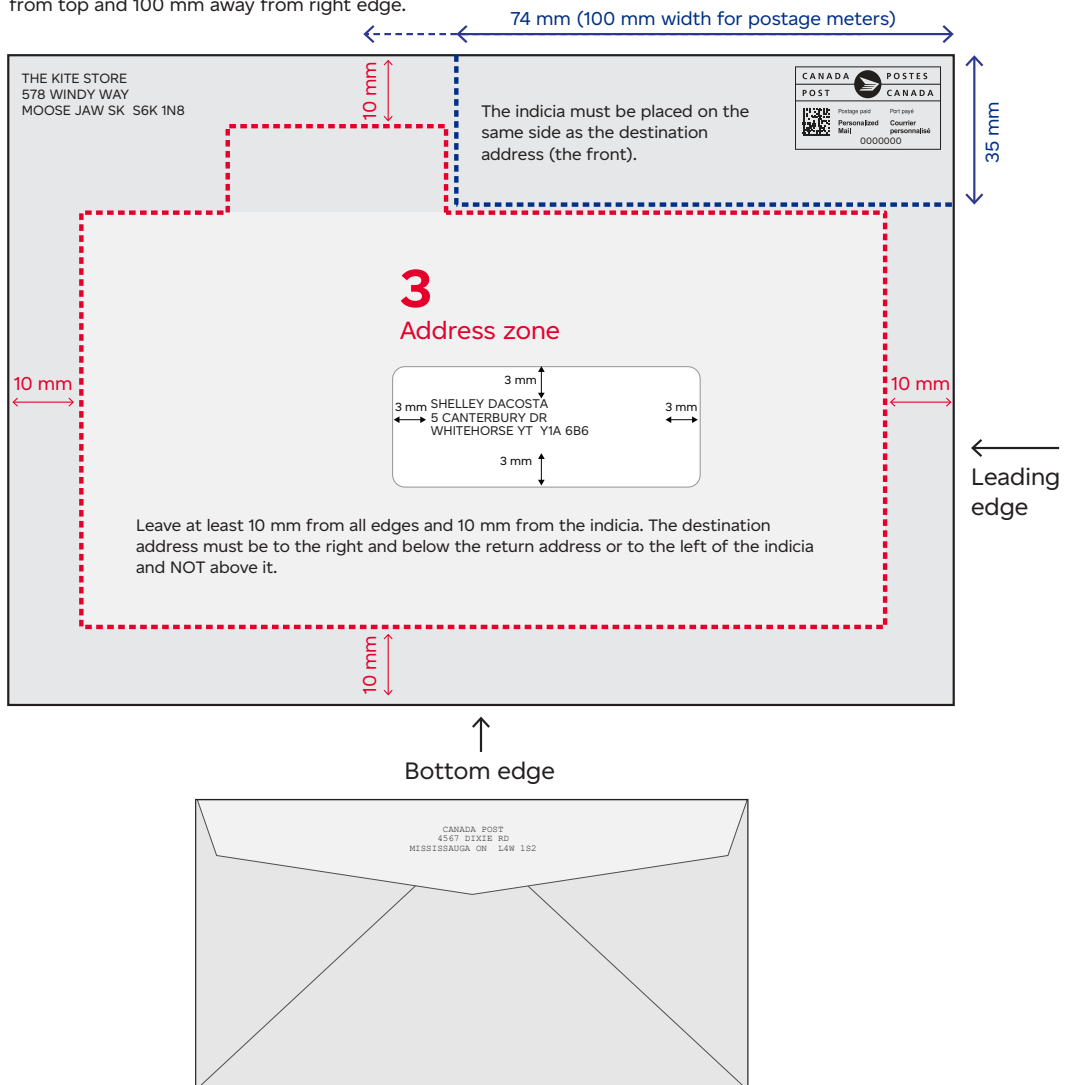

Designing Neighbourhood Mail

Mandatory requirements

Category	Size	Length	Width	Thickness*	Weight**
Standard and Oversize	Min.	70 cm ² (10.85 in. ²) area	70 cm ² (10.85 in. ²) area	0.18 mm (0.007 in.)	N/A
Standard	Max.	30.50 cm (12 in.)	15.24 cm (6 in.)	2.54 cm (1 in.)***	500 g (17.64 oz.)***
Oversize	Max.	30.50 cm (12 in.)***	28.00 cm (11 in.)	2.54 cm (1 in.)***	500 g (17.64 oz.)***

* The thickness of a Neighbourhood Mail item must be measured at the thickest area of the item.

** No Neighbourhood Mail item weighing over 50 g may be deposited if it has not received Canada Post's pre-authorization for deposit (see following section for details).

***The dimensions for non-letter carrier routes are: No minimum dimension requirements. The maximum dimensions are length 35.56 cm (14 in.), width 28.00 cm (11 in.), thickness 3.81 cm (1.5 in.) and weight 1,000 g (35.3 oz.).

Pre-authorization for Neighbourhood Mail items weighing over 50 g

Due to limited network capacity, you may not deposit any Neighbourhood Mail items weighing over 50 g without first receiving Canada Post's pre-authorization. Contact a Commercial Service Network (CSN) representative at 1-866-757-5480 if your proposed Neighbourhood Mail items weigh over 50 g. You will need to provide such information as reasonably requested by Canada Post when seeking pre-authorization.

If you intend on depositing Neighbourhood Mail items weighing over 50 g on a weekly (or more frequent) basis, you must also provide a mailing plan when seeking Canada Post's pre-authorization. The mailing plan must include such information as reasonably requested by Canada Post, including but not limited to:

- the proposed deposit locations and frequency
- the dates and time of the deposits and the quantities to be deposited at each location, and
- a breakdown of the planned offices of delivery and the volumes for each office, by Forward Sortation Area (FSA) and delivery mode.

To address limited network capacity, Canada Post reserves the right, in its sole discretion, to refuse, and/or impose geographic, timing, and/or other constraints, on any Neighbourhood Mail items weighing over 50 g. Canada Post will advise you of its refusal, imposed constraint(s), or approval (as applicable) no later than 25 business days (excluding weekends and statutory holidays) after receiving all information reasonably requested by Canada Post to make its determination.

Any pre-authorization granted by Canada Post applies only to the mailing(s) for which it was granted, and not to future mailings.

You must seek Canada Post's pre-authorization for any changes made to a previously approved mailing plan.

Format

Customer identification

Canada Post requires the customer's name, which can include the advertiser, the owner of the agreement, an authorized user, the mailed on behalf of or the mailed by to be visible on the outside of the mail item.

No destination address

Items must be unaddressed but may bear wording, such as "HOUSEHOLDER", "OCCUPANT", "RESIDENT", "BUSINESS OWNER", "MARKETING MANAGER", "PURCHASING MANAGER" or "BOXHOLDER" without a destination address.

Note: There are no postal indicia for the Neighbourhood Mail service. Postal indicia markings are not acceptable on Neighbourhood Mail items with the **exception of the Business Reply Mail indicia and/or the "Basic Identifying Information" for Publications Mail items** mailed as Neighbourhood Mail.

Co-op mailings

A co-op mailing is promotional content from two or more organizations, typically printed as booklets, cards or enclosed in an envelope.

Co-op mailings are not:

- Catalogues
- Directories
- Newsletters
- Calendars
- Community newspapers

The inclusion of the mailer/sender identification (customer name and/or logo) is not considered promotional content. Canada Post reserves the right to refuse, at its sole discretion, any co-op mailing that does not meet its criteria, including, without limitation, a mailing by a customer that is primarily engaged in the reselling of the co-op item, rather than promoting its own products or services.

Enclosures and attachments

- Samples (trial size portion). It may be distributed on its own, attached, or enclosed in an envelope with or without printed matter. A sealed envelope may contain a single sample or multiple samples. The price is based on the overall weight of the item, including the sample(s).
- Magnets are not acceptable unless they are enclosed or attached with the magnetize portion of the item is covered.
- A Business Reply Mail item (card or envelope).
- Inserts can be placed in a newspaper, magazine, catalogue, envelope or self-mailer. To be acceptable the Inserts must be attached, enclosed or folded into the item in order to become an integral part of the item and not become separated during normal handling of the mail. You must **perform a "pinch test"**. This is done by placing the middle of the item's fold (or spine) in the palm of your hand, between your thumb and fingers. Grasp the item tightly, and shake it back and forth (horizontally)

with its open end facing downward. If the inserts become separate during this test, the item is not acceptable and must be reworked by the customer, who can do one of the following:

- enclose the item, including inserts, within a “plastic” wrapper or envelope (also referred to as a polybag)
- affix stickers, tape or tabs to the top and bottom open edges of a folded item, or on the open edge opposite the fold, or on all the open edges
- enclose the inserts into a newspaper by enclosing all inserts within one insert or wrapper to create one spine and then placing the insert package within one quadrant of the newspaper, ensuring the spine of the insert is facing the outside edge of the newspaper
- place the inserts within the pages of the item and then fold the item to form a common fold
- if there are two sections to the item, place the insert between the two sections and then fold the item to form a common fold
- staple the inserts, provided that the staples are enclosed or covered in a manner that prevents exposure during normal handling
- glue the inserts, provided that both the glue and the paper are strong enough to retain the insert within the item.

Note: Ensure each item, including any sample(s), is mailable and consider the special packaging requirements (e.g. scented items, common allergen items. Items must be packaged properly and labelled to minimize the potential for allergic reactions.

Creative options

Die-cut mail

- minimum of 7-point card stock to prevent the item from bending,
- non-printed matter such as rubber, plastic, laminate, vinyl, leather or wood (subject to testing and approval).

Application of tip-ons

- firmly affixed with glue and does not separate from the item during normal processing,
- lie flat on the item,
- if magnetized, must be weak enough to be handled without de-magnetizing the contents of other items (e.g., credit cards).

Repositionable notes (RPN)

- applied with a glue strip that must be a minimum of a third (1/3) of the total width of a repositionable note (e.g., 26 mm (1 in.) wide for a 76 mm (3 in.) label),
- applied mechanically,
- applied anywhere on the item,
- applied on paper-based coverings, such as envelopes

Scented items

- unsealed mail items containing micro-encapsulated inks and lacquers. To prevent premature release of the scent, the scented patch must be covered or contained within the mail item,
- sealed mail items containing scents that are not micro-encapsulated inks and lacquers must be sealed in such a manner that prevents the scent from escaping.

Variable printing

- contain variable printing, such as different offers or business locations, and do not require specific delivery instructions, are acceptable for delivery provided that the item's customer identification, physical dimensions, and advertised products or services remain the same,
- will be distributed at random and do not require special bundling and labelling requirements.



Smartmail Marketing Preparing requirements

Ensure your mailing can be
processed and delivered efficiently



Smartmail Marketing™

Preparing requirements

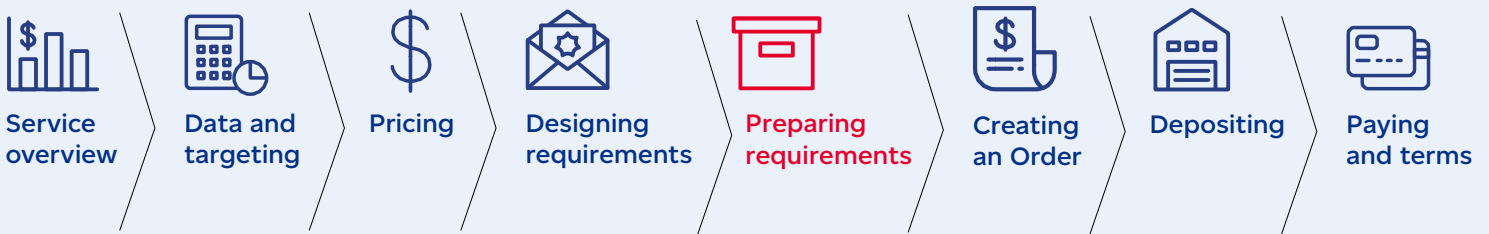

There are two ways to process your mail items:

1. Through our machines – Machineable Mail
2. Not processed through our machines – Special Handling and Neighbourhood Mail.

Are you preparing...

Description	Personalized Mail	Postal Code Targeting	Neighbourhood Mail
Machineable Mail requires mailers to face and containerize the mail items, label containers and label shipping units.	yes	yes	N/A
Special Handling requires mailers to sort their mail items for specific letter carrier walks (or other delivery routes) using presortation software recognized by Canada Post.	yes	yes	N/A
Neighbourhood Mail	N/A	N/A	yes



Types of container and shipping units

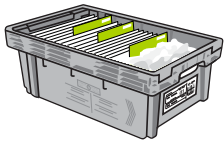

Letterflatainer



Flats tubs



Flexipack pouch



Customer
supplied
containers

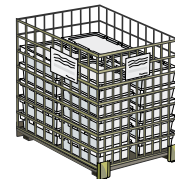

Monotainer



Pallet

When you target multiple delivery facilities in a mailing, you may vary the type of containers used, provided the same type of container is used at a given delivery facility. Container dimensions are the measurements inside the container. Imperial equivalents are provided for your convenience.

Canada Post supplied containers	Length	Width	Height	Container weight (without lid)	Maximum weight (including mail, container and lid)
Letterflatainer (LFT) – Standard items	394 mm (15.6 in.)	244 mm (9.6 in.)	156 mm (6.1 in.) with lid	0.995 kg (2.2 lb.)	22.7 kg (50 lb.)
Flats tubs – Oversize items	405 mm (15.9 in.)	240 mm (9.4 in.)	303 mm (11.9 in.)	1.7 kg (3.7 lb.)	22.7 kg (50 lb.)
Flexipack pouch Neighbourhood Mail only (re-order number: Article 241558)	N/A	406 mm (16 in.)	305 mm (12 in.)	N/A	6 kg (13 lb.)

Note 1: LFTs are designed to work without lids.

Note 2: Flats tubs should be deposited with lids. If lids are not available, we recommend cardboard separators be used between each level to protect your mail items.

Customer supplied containers	Length	Width	Height	Container weight (without lid)	Maximum weight (including mail, container and lid)
For Standard and Oversize items	535 mm (21.06 in.)	251 mm (9.8 in.)	303 mm (11.9 in.)	N/A	22.7 kg (50 lb.)

Note: Customer-supplied cardboard containers must meet the requirements, be completely sealed and be sturdy to withstand handling during processing.

Shipping unit type

Shipping unit	Weight	Length	Width	Height	Maximum weight (including mail and shipping unit)
Monotainer	97 kg (213.8 lb.)	1.322 m (52 in.)	1.067 m (42 in.)	1.115 m (43.8 in.)	900 kg (1,984.2 lb.)
Pallet (plastic and wood) (minimum ordering quantity is 40 units.)	9 kg (19.8 lb.)	1.22 m (48 in.)	1.02 m (40 in.)	1.5 m (59 in.)	900 kg (1,984.2 lb.)

For information on how to construct your pallet, see [Appendix B: Pallet Construction Specifications](#).

Ordering equipment

You may enquire about or order our equipment (containers and shipping units) by contacting the National Empty Container Facility (NECF) order desk by phone at 905-565-0480, by fax at 905-564-6830, by email at necfteo@canadapost.ca or through a Regional Equipment Coordinator.

The supply of our equipment depends on conditions and availability. When our equipment is not available, Canada Post pre-approved customer-supplied containers (e.g., cardboard boxes) and/or pallets must be used.

List of Regional Equipment Coordinators

Region	Contact information
Atlantic	Nova Scotia/Prince Edward Island Halifax tel.: 902-494-4001 ext. 44707
	New Brunswick Moncton tel.: 506-381-5347 Saint John tel.: 506-653-5270
Greater Toronto Area	National Empty Container Facility (NECF) Tel.: 905-565-0480 Fax: 905-564-6830 Email: necfteo@canadapost.ca

Region	Contact information
Huron Rideau	Ottawa Tel.: 613-734-1431 Email: equipmentline.ompp@canadapost.ca
	Hamilton National Empty Container Facility (NECF) Tel.: 905-565-0480 Fax: 905-564-6830 Email: necfteo@canadapost.ca
	London Tel.: 519-473-6738
Pacific	Vancouver Tel.: 604-276-5538
Prairies	Winnipeg Tel.: 204-987-5100, ext. 72045
	Edmonton Tel.: 780-945-2600, ext. 53292 Fax: 780-945-2608
	Calgary Tel.: 403-974-2000, ext. 2170

Region	Contact information
Quebec	Montréal Tel.: 514-345-7369 Email: uvcr.mtl@canadapost.ca

Our equipment may be used only when you use Canada Post products or services. It remains our exclusive property. Personal use is not permitted. You are responsible for ensuring that the equipment remains in good condition; reasonable wear-and-tear is acceptable.

Preparing Machineable Mail

Requirements

Placing mail items in acceptable containers

- In order to help facilitate mail processing, customers should not fill containers to full capacity. Space should be left for an operator to insert both hands in the container to remove the mail.
- Only the last container may be less than full. To maintain the integrity of the mail, we recommend using packing material to protect mail items from shifting.
- Ensure the items do not stick together as they may be damaged during processing or jam and/or damage the equipment.

Letterflatainers (LFTs)

For **horizontal** address orientation, the postal indicia must appear in the upper right-hand corner.

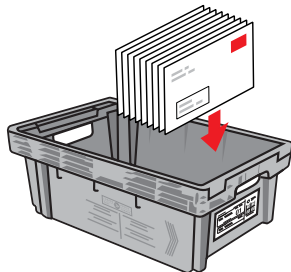

For **vertical** address orientation, the postal indicia must appear in the upper left-hand corner.

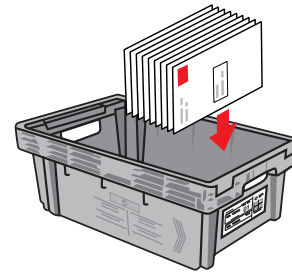

Flats tub

For items too wide to fit, place the mail **standing horizontally**.

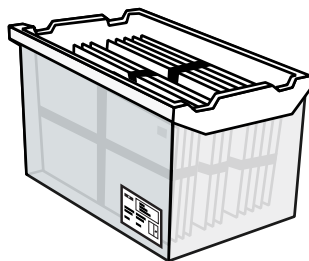

Mail can be placed within the container **laying flat**.

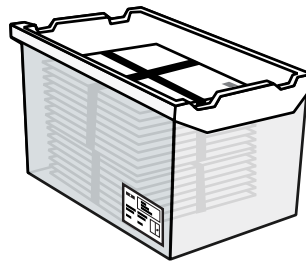

Mail can be placed **standing vertically** facing the narrow side of the flats tub.

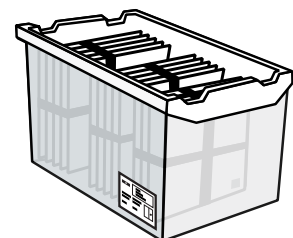

Labelling containers

All containers must be labelled and be bilingual. Labelling individual containers is not required only if all containers are placed in monotainers or on pallets. For label specifications, visit canadapost.ca/labels.

Note: Large-volume mailers may choose between producing labels individually or in continuous strips (1 up, 2 up, etc.) as best suited to the intended overprinting process.

Routing information

- Service name
- Service size/item

Example of container label

If you are using Canada Post-supplied containers, insert your container label into the label holder prior to depositing your mailing.

If you are using customer-supplied cardboard containers, affix a container label on the side of each container. You can order self adhesive labels online at canadapost.ca/obc under form number 33-086-732 or by telephone at 1-888-550-6333.

We recommend that the Order (Statement of Mailing) number be written on the label. For customers wishing to include other internal directives on the shipping containers, a label colour different than white is recommended.

Examples of labels

Label (not SERP generated)

Order (Statement of mailing)

Service name

Service option

Example of optional 2D barcode label (SERP generated)

Placing containers in shipping units

Shipping units (monotainers and pallets – also referred to as skids) are used to group containers intended for one Order or bound for the same destination (e.g., all mail items for Vancouver arrive on one pallet). This reduces the handling and helps ensure timely delivery.

Shipping Unit	Personalized Mail	Postal Code Targeting
Pallet	Minimum: No minimum requirement Maximum: <ul style="list-style-type: none"> • 48 LFTs, or • 32 flats tubs, or • 1.5 m (including pallet height) 	Minimum: No minimum requirement Maximum: <ul style="list-style-type: none"> • 48 LFTs, or • 1.5 m (including pallet height)
Monotainer	Minimum: No minimum requirement Maximum: <ul style="list-style-type: none"> • 48 LFTs (40 LFTs with lids) • 24 flats tubs or contents may be piled up to 25 mm below the top of the monotainer 	Minimum: No minimum requirement Maximum: <ul style="list-style-type: none"> • 48 LFTs (40 LFTs with lids)

Securing pallets

All pallets must be securely fastened and structurally sound to safely handle and transport.

If using plastic pallets, it is recommended to apply four cross straps encompassing both the pallet bottom and the containers. Metal strapping is not permitted.



Stacking pallets or monotainers

Note: Not all locations are equipped to process mail received in monotainers or pallets that are double-stacked. See the Find a Deposit Location tool at canadapost.ca/depotlocations to ensure the deposit location is properly equipped to handle your mail.

Multiple pallets going to the same destination, as per the National Presortation Schematic (NPS), may be stacked on top of each other as long as they are secured together with straps. Stacking during storage and transportation uses warehouse space more efficiently. For example, where there are two pallets – one going to Vanier Station and one going to Merivale depot – these two pallets may be strapped together and identified to Ottawa (City Consolidation).

Pallets

Two pallets strapped together must not exceed 1.5 m (4.9 ft.) or 900 kg (1 ton) in weight.

Monotainers

Two monotainers stacked together must not exceed 1,800 kg (2 tons); each monotainer must not exceed 900 kg (1 ton).

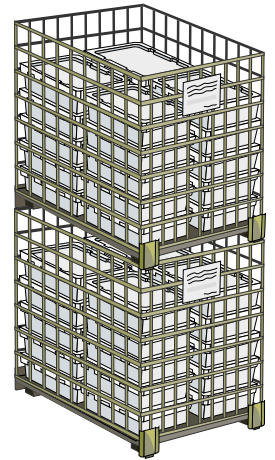
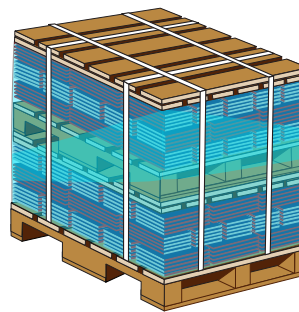

Labelling shipping units

Label specifications

All pallets and monotainers must be labelled. This will ensure that your mail is directed to the appropriate facility within Canada Post's network. For customers using SERP software to prepare their Machineable Mail, a 2D barcoded shipping unit label is available and optional.

Labels must be white and meet the following requirements:

- measure 279 mm x 216 mm (11 in. x 8.5 in.) in letter landscape or letter portrait format. Labels may also be prepared in legal portrait format 216 mm x 355 mm (8.5 in. x 14 in.),
- be printed in black in a font size large enough to occupy the entire label,
- prominently display the facility name (which must be visibly larger than all other information),
- be visible on two sides on the pallet or monotainer.

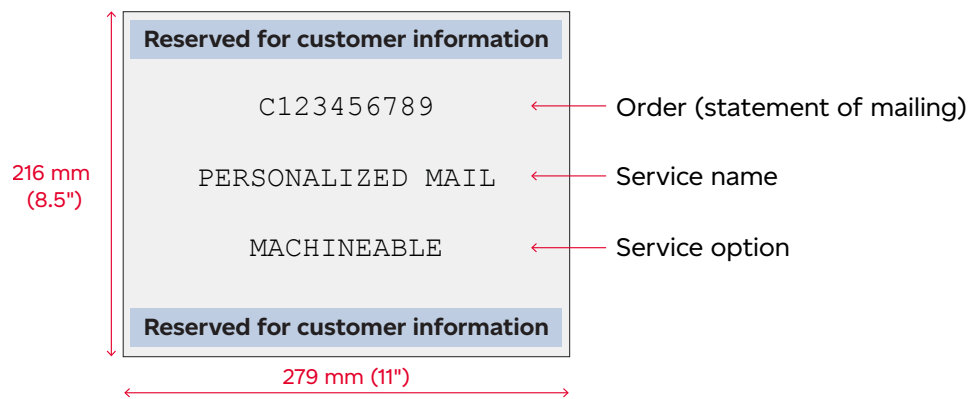

Routing information

- Service name
- Service option

We recommend that the Order number be written on the label. For customers wishing to include other internal directives on the shipping containers, a label colour different than white is recommended.

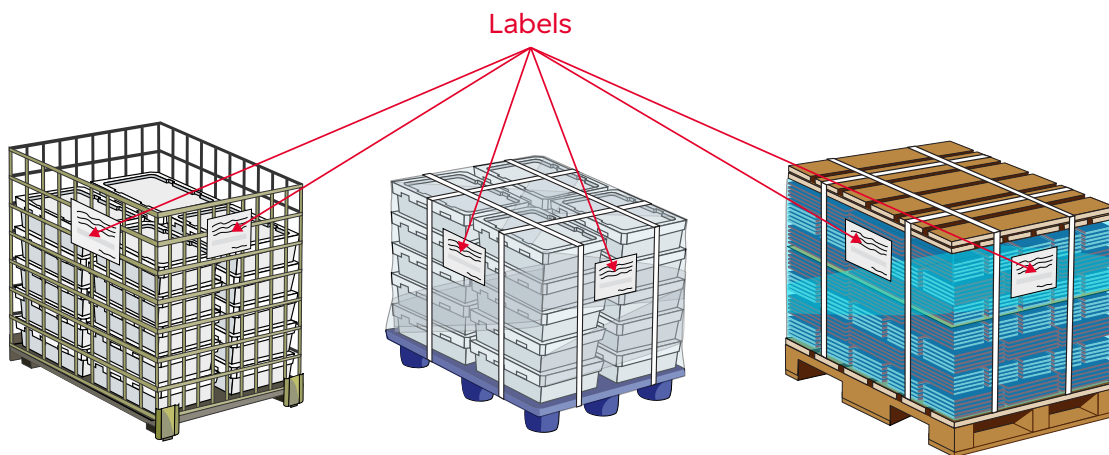

Preparing Special Handling

Special Handling is available for customers who want to be creative or for customers who would prefer that their mail items not be processed on our machines.

Ensure you are using a presortation software recognized by Canada Post. The software does the following:

- sort mail items by their postal code, and according to the delivery route identified by the Delivery Mode Code (DMC)
- groups mail items by a common destination according to the National Presortation Schematic (NPS).

Special Handling elements

Software Evaluation and Recognition Program (SERP)

Our Software Evaluation and Recognition Program (SERP) exists to evaluate the accuracy of presortation software programs.

For more information or to find a list of our approved software vendors, visit canadapost.ca/presortationsoftware.

Postal code

The postal code is a six-character alphanumeric code in the form of ANA NAN, in which “A” represents a letter of the alphabet, and “N” represents a number. It is an integral part of every postal address in Canada, and was designed to help sort mail, both mechanically and manually.

Rural areas are identified by a zero in the FSA (e.g., MOL 3K2).

For more detailed information, visit [Section 5](#) of Addressing guidelines in the *Canada Postal Guide*.

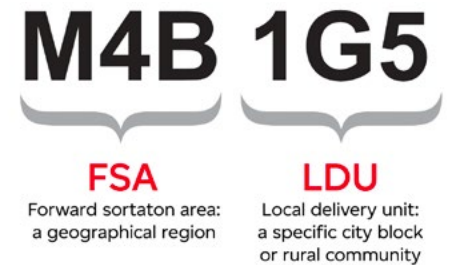

Delivery Mode Code (DMC)

The Delivery Mode Code is an identifier of a specific delivery route (also known as mode) for an individual address.

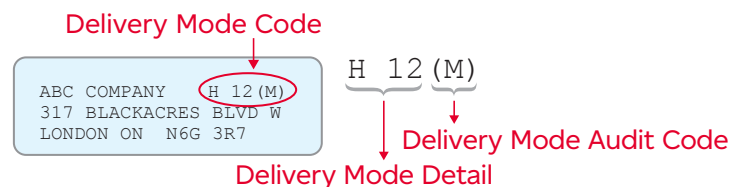

The DMC consists of two parts, a Delivery Mode Audit Code (DMAC) and a Delivery Mode Detail (DMD).

The **Delivery Mode Detail (DMD)** identifies the letter carrier route or delivery mode as well as the letter carrier responsible for delivery.

The **Delivery Mode Audit Code (DMAC)** identifies which version of the National Presortation Schematic (NPS) and Delivery Mode Data Product (DMAC) was used to prepare a mailing.

The DMC must be printed and placed in the address block of every item.

Delivery Mode Code Placement. The DMC may appear on any non-address line in or above the address block, that is, on any line that does not contain delivery information. When placed on the same line as street addresses, city or province names, or postal codes, a 10 mm space between the delivery address information line and the DMC must be maintained.

DMC Placement on addresses – Personalized Mail

With three or more lines

3 to 4 blank spaces to the right of the non-address line.

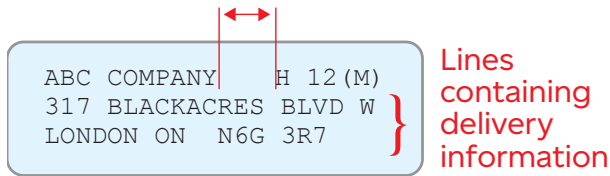

With four or more lines

3 to 4 blank spaces to the right of the longest non-address line.

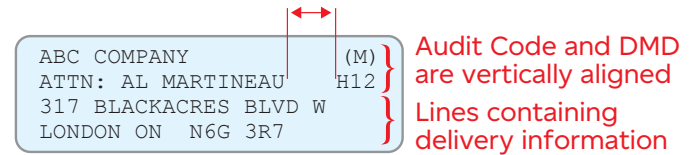

Above the address block

Up to 2 lines above the address block, 3 to 4 blank spaces to the right of the non-address line.

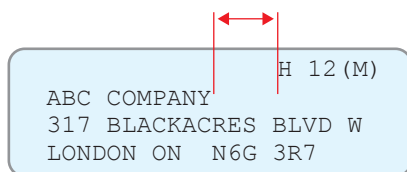

On the same line

A 10 mm (0.4 in.) space between the delivery address information line and the DMC must be maintained.

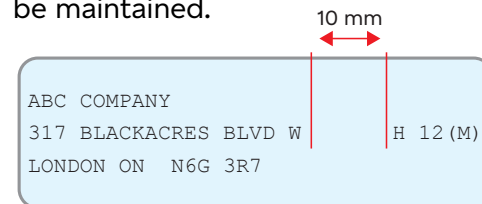

DMC Placement on non-personalized addresses – Postal Code Targeting

Above the address block

Up to 2 lines above the address block, 3 to 4 blank spaces to the right of the non-address line.

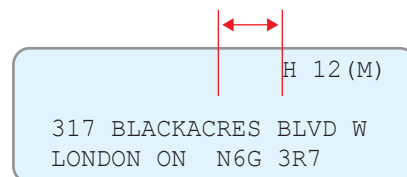

On the same line

A 10 mm (0.4 in.) space between the delivery address information line and the DMC must be maintained.

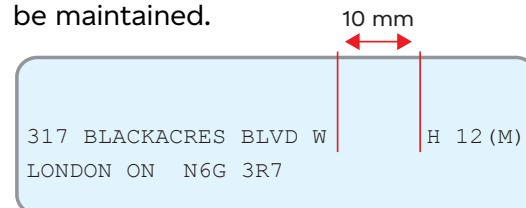

National Presortation Schematic (NPS)

The National Presortation Schematic (NPS) indicates how mail is distributed through specific Canada Post facilities. It lists all Forward Sortation Areas (FSAs) and shows how to consolidate mail into groupings and containers. The four NPS levels of consolidation are:

Level	Level 1 – DF	Level 2 – City	Level 3 – DCF	Level 4 – FCP
Consolidation	Delivery facility	City	Distribution centre facility	Forward consolidation point

Any mail items that cannot be consolidated into one of these four levels will be consolidated as Residue. Canada Post updates the NPS monthly to reflect the changes in Canada's addresses. These monthly updates also appear in presortation software recognized by Canada Post. To avoid delays and extra handling charges, you must use the current version of both the Delivery Mode Data and the recognized presortation software. For detailed information, visit canadapost.ca/nps.

Grouping and identifying mail items

All items in a mailing must be part of a grouping. All groupings (except Residue) must have a minimum of eight items. If this minimum requirement is not met, the items are consolidated to the next level.

Once your mail has been presorted, make sure it can withstand handling. Preserve the integrity of your groupings by separating them in their containers, using one of the following acceptable methods: Bundling, Separator Cards and Edgemarking.

Levels of groupings

Type of groupings	Presortation software groups mail items that have a common destination and/or sortation
Delivery Mode Direct (DMD)	Group all items delivered by the same letter carrier.
NPS Level 1 – Delivery Facility (DF)	Group all items delivered from the same postal station or letter carrier depot.
NPS Level 3 – Distribution Centre Facility (DCF)	Group all items delivered in the same area, such as a city and surrounding area.
NPS Level 4 – Forward Consolidation Point (FCP)	Group all items delivered in the same province.
Residue	Place all remaining items into a Residue grouping.

Separating and identifying groupings

Bundling

A bundle is a group of mail items identified and secured together by strapping (e.g., elastic bands, string, or plastic straps) or by shrink-wrapping. Shrink-wrapping is an acceptable method of bundling for Oversize and Dimensional items only. When a bundle exceeds the maximum thickness, it is preferable to make two evenly divided bundles.

The maximum thickness takes precedence over the minimum number of items. The last Residue bundle has no minimum number of items, although it still must not exceed the maximum thickness per bundle.

Type of mailing	Maximum bundle thickness	Minimum number of items per bundle
Standard	100 mm (4 inches)	8 items
Oversize and Dimensional	200 mm (8 inches)	8 items

Identifying bundling options

Option 1 – Bundling labels

When using bundling as a separation method, DCF, FCP and Residue bundles must be identified with a bundle label (also called a facing slip). DMD and DF bundles do not require labels.

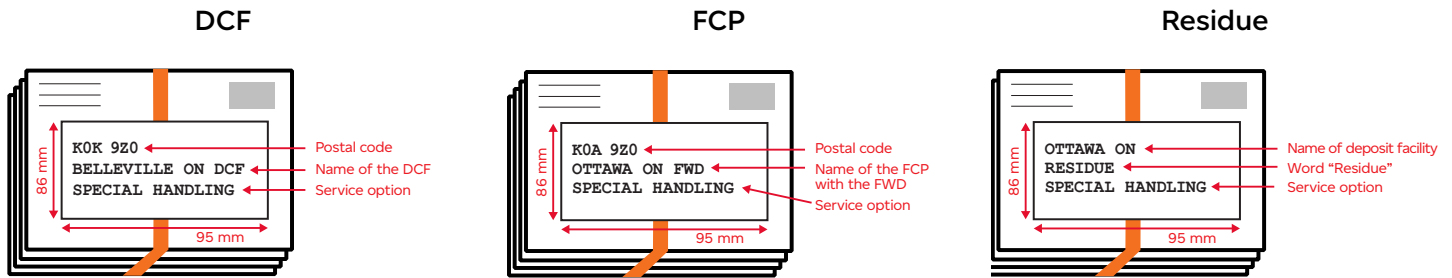

Category	DCF	FCP	Residue
Routing information on bundle labels	<ul style="list-style-type: none"> Postal code of the DCF, as per the NPS (e.g., KOK 9Z0) Name of the DCF (e.g., BELLEVILLE ON DCF) Service size/item 	<ul style="list-style-type: none"> Postal code of the FCP, as per the NPS (e.g., KOA 9Z0) Name of the FCP with the forward abbreviation FWD (e.g., OTTAWA ON FWD) Service size/item 	<ul style="list-style-type: none"> Name of the deposit facility (e.g., OTTAWA ON) The word “RESIDUE” Service size/item

Additional information may appear above or below the routing information as long as the routing information is more prominent.

Option 2 – Optional endorsement line (OEL)

OELs can be generated by the presortation software and printed directly onto the first mail item in each bundle. OELs must meet the following requirements:

- consolidation information is printed on the top line of the address block or label
- font type and size are identical to that of the address (an UPPERCASE font is recommended), and
- is visible if positioned within a window.

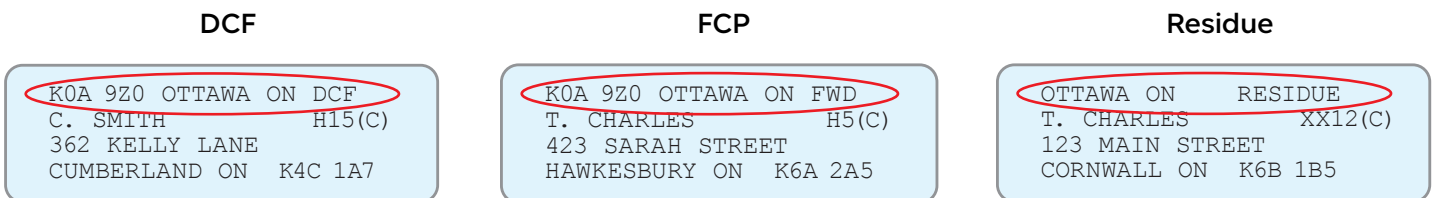

Securing bundles

The **strapping material** must be strong and tight enough to hold the bundle together, without the contents sliding, when held vertically.

Size/item	Strapping requirement
Standard items Oversize items Only for bundles placed in Level 1 (DF) containers	Single strapping <ul style="list-style-type: none"> • Plastic or paper strapping material • Elastic bands when placed in hardsided containers or customer supplied boxes • It is recommended, but not mandatory, to apply the strapping to the shorter dimension of the bundle.
Oversize and Dimensional Except for bundles placed in Level 1 (DF) containers	Double strapping <ul style="list-style-type: none"> • Strings or manually applied plastic straps.

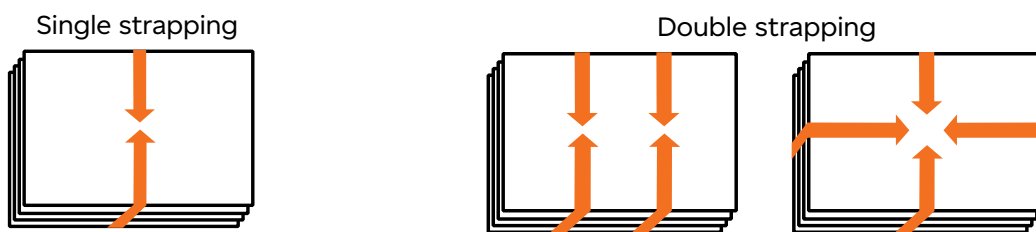

If your mail items are bound using spines, to create an even bundle, you may place the bottom half and top half of the bundle with their spines facing in opposite directions.

Note: Shrink-wrapping is an acceptable method of bundling for Oversize and Dimensional items.

The plastic used for shrink-wrapping must be strong enough to ensure the bundles remain secured during handling.

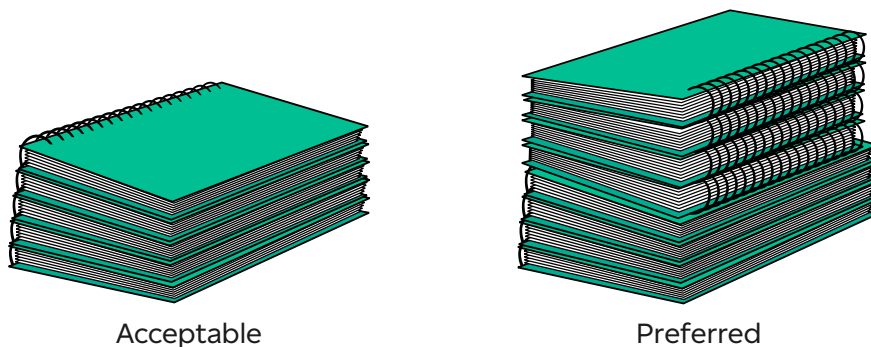

Separator cards

- be made of thin, rigid cardboard of any colour (a weight of 120 to 160 grams per square metre)
- extend at least 20 mm (0.8 in.) above the mail items
- be at least 155 mm (6.1 in.) wide
- be placed in front of the first mail item in each grouping. If a grouping is too large to fit into one container, a second separator card is required at the front of the second container.

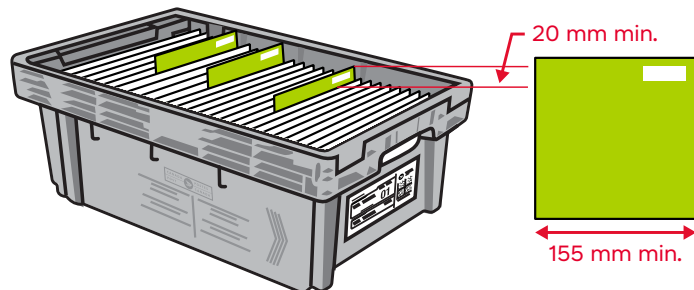

When using **separator cards** as a separation method, you must identify each DCF, FCP and Residue grouping on the part of the separator card visible above the mail items. The following information must be provided.

Category	For DCF groupings	For FCP groupings	For Residue groupings
Required information	<ul style="list-style-type: none"> • Postal code of the DCF, as per the NPS (e.g., K0K 9Z0) • Name of the DCF (e.g., BELLEVILLE ON DCF), and • The service size/item 	<ul style="list-style-type: none"> • Postal code of the FCP, as per the NPS (e.g., K0A 9Z0) • Name of the FCP with the forward abbreviation FWD (e.g., OTTAWA ON FWD) • The service size/item 	<ul style="list-style-type: none"> • Name of the deposit facility (e.g., OTTAWA ON) • The word “RESIDUE” • The service size/item

Edgemarking

The following requirements must be met:

- their colour significantly contrasts with that of the mail item
- the same colour is used for edgemarking the entire mailing
- the edgemarking begins approximately 40 mm from the upper-right edge of the mail item.

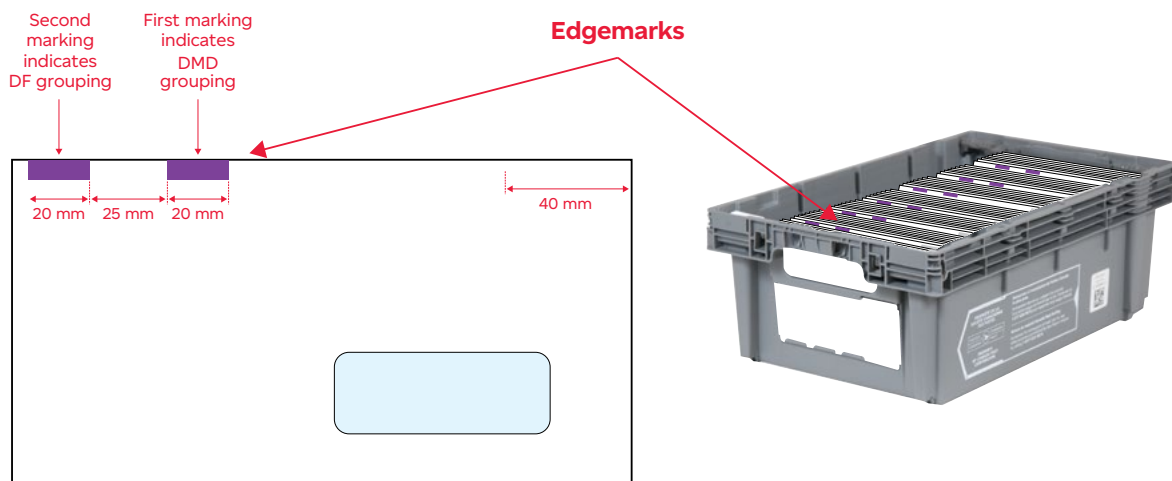

The edgemarks should be approximately 20 mm (0.8 in.) long, separated by a gap of approximately 25 mm (1 in.):

- the marking nearest the upper-right edge indicates a Delivery Mode Direct (DMD) grouping
- the additional markings indicate Delivery Facility (DF), Distribution Centre Facility (DCF) and Forward Consolidation Point (FCP) groupings.

It is acceptable for DCF and FCP groupings to have only two marks, but the marks must be in the DMD and DF locations.

Filling containers

To help mitigate operator injuries when our employees are processing your mail, we are requesting that you do not overfill containers. We recommend 2 inches of space be left in a container to allow an operator to remove the mail. A simple way to this is to tilt the Letterflattainer (LFT) on an angle so that the envelopes gravitate downward, when about 2 inches remain, the container is at capacity. This practice also helps to protect your mail items from damage.

Minimum requirements for filling containers

Consolidation level	If only one container to a destination		If multiple containers to a destination	
	Fill to capacity of:		All containers except the last, fill to capacity of:	Last container, fill to capacity of:
Level 1 – DF	50%		95%	No minimum
Level 2 – City	70%		95%	No minimum
Level 3 – DCF	70%		95%	No minimum
Level 4 – FCP	50%		95%	No minimum
Residue	No minimum		95%	No minimum

Preserving integrity of mail preparation

For any container with less than 95% of capacity, when using:

- **separator cards or edgemarking** as a separation method, you must use packing
- **bundle with strapping** as a separation method, we recommend adding packing

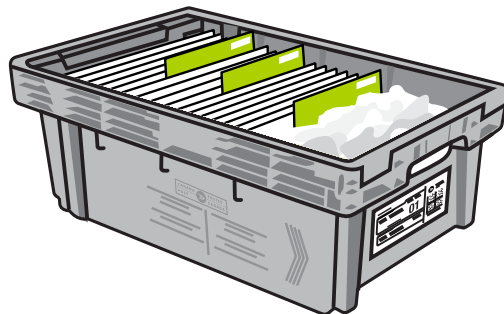

Labelling containers

All containers must be labelled with their destination details using routing information from the National Presortation Schematic (NPS). Correctly labelling your containers will ensure your mail is directed to the appropriate work centre within a Canada Post facility.

Note: The use of 2D barcoded container labels for Special Handling mailings is mandatory. The presortation software will provide the information you need to print on container labels. These labels must be bilingual.

Labels for Residue monotainers or pallets and all labels generated without the use of SERP software must display the name of the deposit facility and the word “Residue”.

Note: In order to avoid delays or extra handling charges, it is extremely important to follow the SERP mailing plan instructions.



Placing containers in shipping units

Shipping units (monotainers and pallets – also referred to as skids) are used to group containers or to brick-pile mail intended for one Order or bound for the same destination (e.g., all mail items for Vancouver arrive on one pallet). This reduces the handling and helps ensure timely delivery.

Filling shipping units requirements

Type of shipping unit	Destination	Minimum	Maximum
Pallet	Any (when using containers)	<ul style="list-style-type: none"> • 18 letterflatainers (LFTs), or • 12 flats tubs, or • 500 mm (19.7 in.) (excluding height of pallet) 	<ul style="list-style-type: none"> • 48 letterflatainers (LFTs), or • 32 flats tubs, or • 1.5 m (including height of pallet)
Monotainer	Mail destined within the province of deposit	<ul style="list-style-type: none"> • 18 letterflatainers (LFTs), or • 12 flats tubs 	<ul style="list-style-type: none"> • 48 letterflatainers (LFTs) (40 letterflatainers with lids), or • 24 flats tubs or contents may be piled up to 25 mm (1 in.) below the top of the monotainer
	Mail destined outside the province of deposit	<ul style="list-style-type: none"> • 27 letterflatainers (LFTs), or • 18 flats tubs 	<ul style="list-style-type: none"> • 48 letterflatainers (LFTs) (40 letterflatainers with lids), or • 24 flats tubs or contents may be piled up to 25 mm (1 in.) below the top of the monotainer

Note 1: Detailed information on Brick-piling mail items can be found in [“Appendix A: Brick-piled Mail Items”](#).

Note 2: When pallets are used to consolidate Flexipack pouches, Gaylord-type packaging must be used to stabilize the pallets.

Note 3: Customers preparing mailings in hardsided containers for a direct Urban Delivery Facility or a Rural Delivery Facility (both Level 1) monotainer, may nest hardsided containers without lids. It is recommended that full monotainers be covered with cardboard to protect the load. Nesting of hardsided containers without lids is not acceptable when using pallets.

Labelling shipping units

All pallets and monotainers must be labelled. SERP generated labels contain a 2D barcode. This will ensure that your mail is directed to the appropriate facility within Canada Post's network. **We recommend that the Order number be written on the label.**

Routing information

- the service name (Personalized Mail/ Courier personnalisé or Dimensional Personalized Mail/Courrier personnalisé extradimensionnelle)
- the service size/item (Special Handling/Manutention spéciale)



Two sides of the pallet or monotainer must be labelled

For customers wishing to include other internal directives on the shipping containers, a label colour other than white is recommended.

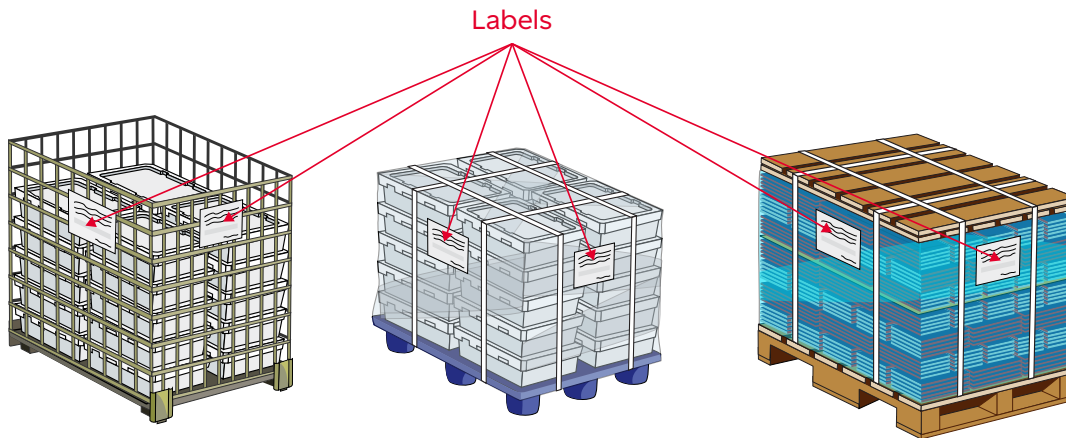

Securing pallets

All pallets must be securely fastened and structurally sound to safely handle and transport.

If using plastic pallets, it is recommended to apply four cross straps encompassing both the pallet bottom and the containers. Metal strapping is not permitted.



Stacking pallets or monotainers

Multiple pallets going to the same destination, as per the National Presortation Schematic (NPS), may be stacked on top of each other as long as they are secured together with straps. Stacking during storage and transportation uses warehouse space more efficiently. For example, where there are two pallets – one going to Vanier Station and one going to Merivale depot – these two pallets may be strapped together and identified to Ottawa (City Consolidation).

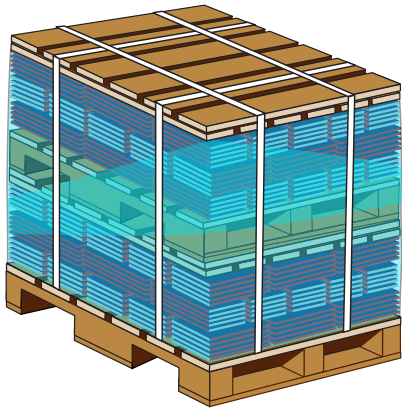

Two pallets strapped together must not exceed 1.5 m (4.9 ft.) in height or 900 kg (1 ton) in weight.

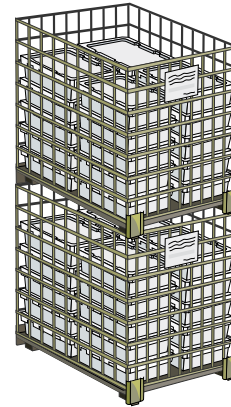

Two monotainers stacked together must not exceed 1,800 kg (2 tons); each monotainer must not exceed 900 kg (1 ton).

Note: Not all locations are equipped to process mail received in monotainers or pallets that are double-stacked. See the Find a Deposit Location tool at canadapost.ca/depositlocations to ensure the deposit location is properly equipped and capable of handling your mail.



Preparing Neighbourhood Mail

Neighbourhood Mail items must be bundled and containerized for the selected mailing and distribution plan.

Pre-authorization for items weighing over 50 g

Before you prepare any mailing containing Neighbourhood Mail items weighing over 50 g, ensure you have received Canada Post's pre-authorization in accordance with the [Designing Neighbourhood Mail](#) section.

Note: If you intend on depositing Neighbourhood Mail items weighing over 50 g on a weekly (or more frequent) basis, you must also provide Canada Post with a mailing plan when seeking pre-authorization. See the [Designing Neighbourhood Mail](#) section for further details.

Distribution and mailing plans

Before you prepare the mailing, you need a distribution plan or a mailing plan. These plans will guide the number of containers for each delivery facility and the labelling.

Distribution and mailing plans

Before you prepare the mailing, you need a distribution plan or a mailing plan. These plans will guide the number of containers for each delivery facility and the labelling.

Residential and business delivery area counts and maps

Delivery Area Counts

Information about the delivery areas served by our delivery offices is segmented into the number of houses, apartments, farms and business points of call that help customers determine the number of items needed for their mailing. The national database of Householder Counts is available by download from a secured Canada Post FTP site on a 12-month subscription basis, which includes monthly updates. Visit canadapost.ca/data to find out more about Householder Count Data or send an email to data.solutionscentre@canadapost.ca.

FSA Maps

The FSA Maps identify the specific geographic boundaries for every FSA in Canada. The maps will assist in determining sales territories, plan coverage for a marketing campaign, or study new locations for a retail store or business.

Route Maps

Residential and Business Delivery Area Maps provide the actual routes (walks), covered by the Letter Carriers. This is particularly useful for targeting local neighbourhoods.

Note: Visit canadapost.ca/precisiontargeter to view the FSA Maps online.

Methods of delivery

The methods of delivery are defined in the [Glossary](#).

- Letter Carrier Route (LC)
- Call For (CF)
- Direct (DR/DIR)
- General Delivery (GD)
- Rural Route (RR)
- Lock Boxes (LB/PO Box)
- Suburban Services (SS)
- Motorized Route (MR)

National presortation schematic

The Non-Lettermail National Presortation Schematic (NPS) is used for Neighbourhood Mail service and indicates how mail is distributed through specific Canada Post facilities. It lists all Forward Sortation Areas (FSAs) and shows how to consolidate containers into shipping units. The four NPS levels of consolidation are:

Level	Level 1 – DF	Level 2 – City	Level 3 – DCF	Level 4 – FCP
Location	Delivery Facility	City	Distribution Centre	Facility Forward Consolidation Point

Canada Post updates the NPS monthly to reflect the changes in Canada's addresses. To avoid delays and extra handling charges, you must use the current version of the National Presortation Schematic. For detailed information, visit canadapost.ca/nps.

Bundling

A bundle is a number of mail items secured together, including inserts and samples.

All bundles must contain equal quantities (e.g., bundles of 25, 50, 100), except the last bundle of a mailing for each Delivery Facility which may be smaller and is referred as the Residue bundle. Neighbourhood Mail items, including inserts and samples, must be bundled securely to prevent from breaking open during handling or while in transit to the delivery facility responsible for delivery.

The maximum height of a bundle

Weight categories	Maximum height of each bundle	Maximum weight of each bundle
Items weighing less than 500 g (17.6 oz)	15.24 cm (6 in.)	4 kg (8.8 lb.)
Items weighing 500 g to 1,000 g (17.6 oz to 35.3 oz)	20.0 cm (8 in.)	4 kg (8.8 lb.)

Each Delivery Facility targeted by your mailing will receive at least one bundle. Use the distribution plan generated by Canada Post Electronic Shipping Tools (EST) or Precision Targeter as a reference.

The **strapping material** must be strong and tight enough to hold the bundle together, without the contents sliding, when held vertically.

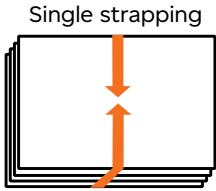
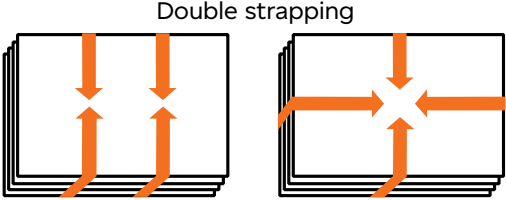
Type of strapping	Description	Strapping requirement
Single strapping	<ul style="list-style-type: none"> Plastic or paper strapping material Elastic bands when placed in hardsided containers or customer supplied boxes. It is recommended, but not mandatory, to apply the strapping to the shorter dimension of the bundle. 	 <p>Single strapping</p>
Double strapping	<ul style="list-style-type: none"> Strings or manually applied plastic straps. 	 <p>Double strapping</p>

Placing bundles into containers

Neighbourhood Mail must be placed in one or more containers for each Delivery Facility.

All containers are to be filled according to the container label, without exceeding 22.7 kg (50 lb). There are no minimum fill requirements when hardsided containers with lids are used. Lids are recommended when containers are less than 50% full, subject to availability.

To maximize the use of container fill, for uneven bundles, items can be placed width-wise or length-wise in the container. When preparing containers, ensure items do not exceed the maximum height.

Labelling containers

All containers must be labelled to their destination based on the Householder Counts or the NPS (Level 1 – Delivery Facility). Canada Post’s shipping tool will generate container labels that meet Canada Post requirements.

Producing labels

Container labels must be bilingual and include the service name. The label serves to identify the Delivery Facility; the mailing; and the service requirements. The following information is required:

Mailed by

Indicate the name and mailing address of the company preparing the mailing for deposit

Mailed on behalf of

The name and mailing address of the company that owns the mail item

Delivery Facility

The name of the Canada Post Delivery Facility as defined in the Canada Post Householder counts information or the NPS Level 1



Number of containers

Indicate the number of containers going to the same Delivery Facility in the format provided (e.g., 2 of 3 means that the container is the second of three containers for the Delivery Facility)

Delivery start date

Indicate the date that delivery is to begin

Options for producing labels

Producing labels

Generated automatically when using

The “Fully Featured” (EST Online or EST 2.0), Precision Targeter application and “Express Order Entry” using blank paper (minimum 20 lb. paper stock) or using Canada Post supplied blank self-adhesive label form #33-086-813 or card stock form #33-086-877. When printing container labels ensure the print setting are set to “Actual Size”.

Customer-generated or manually prepared

The customer prepares their own labels using plain paper, a preprinted label or card stock form available through Canada Post. Visit canadapost.ca/labels.

Order online at canadapost.ca/obc or by calling 1-888-550-6333 or 1-800-260-7678.

Self-adhesive label #33-086-813 should only be used for Customer-supplied containers or Flexipack pouches. If used for Canada Post supplied containers, place into label holder without removing the adhesive label from the protective backing. Both the self-adhesive label and card stock version must fit (or be folded to fit) into the label holder and be easily extracted from the label holders.

- **Canada Post containers:** card stock version must be placed in the container label holder before depositing at a Canada Post facility.

- **Customer-supplied containers or Flexipack pouches:** labels must be placed in the same location on each container, either on the top or the side. For Flexipack pouches, affix the label on the designated area on each pouch.

It is possible to ship Neighbourhood Mail containers using other shipping service options, such as the Canada Post Parcel Services (Priority™, Xpresspost™ or Expedited Parcel™). The Neighbourhood Mail container label must be used along with the shipping label (the specification for the maximum container weight of 22.7 kg [50 lb] applies). The Neighbourhood Mail container label provides mail processing and delivery instructions for your items to the delivery facility. Both the container label and the shipping label must be visible, affixed flat and wrinkle-free, positioned side by side on the flap of the box or on the largest side of the container.

Shipping unit type	Destination	Minimum	Maximum
Pallet	Any (when using containers)	<ul style="list-style-type: none"> • 18 letterflatainers (LFTs), or • 12 flats tubs, or • 500 mm (19.7 in.) (excluding height of pallet) 	<ul style="list-style-type: none"> • 48 LFTs, or • 32 flats tubs, or • 1.5 m (4.9 ft.) (including height of pallet)
Monotainer	Mail destined within the province of deposit	<ul style="list-style-type: none"> • 18 LFTs, or • 12 flats tubs 	<ul style="list-style-type: none"> • 48 LFTs (40 LFTs with lids), or • 24 flats tubs, or contents may be piled up to 25 mm (1 in.) below the top of the monotainer
	Mail destined outside the province of deposit	<ul style="list-style-type: none"> • 27 LFTs, or • 18 flats tubs 	<ul style="list-style-type: none"> • 48 LFTs (40 LFTs with lids), or • 24 flats tubs, or contents may be piled up to 25 mm (1 in.) below the top of the monotainer

Note 1: Detailed information on Brick-piling mail items can be found in [“Appendix A: Brick-piled Mail Items”](#).

Note 2: When pallets are used to consolidate Flexipack pouches, Gaylord-type packaging must be used to stabilize the pallets.

Note 3: Customers preparing mailings in hardsided containers for a direct Urban Delivery Facility or a Rural Delivery Facility (both Level 1) monotainer, may nest hardsided containers without lids. It is recommended that full monotainers be covered with cardboard to protect the load. Nesting of hardsided containers without lids is not acceptable when using pallets.

Labelling shipping units

All pallets and monotainers must be labelled. Labels are generated by Canada Post’s shipping tools.

Label specifications

Labels must be white and meet the following requirements:

- measure 279 mm x 216 mm (11 in. x 8.5 in.) in letter landscape or letter portrait format 216 mm x 279 mm (8.5 in. x 11 in.).
- be printed in black in a font size large enough to occupy the entire label

- prominently display the facility name (which must be visibly larger than all other information)
- be visible on two sides on the pallet or monotainer.

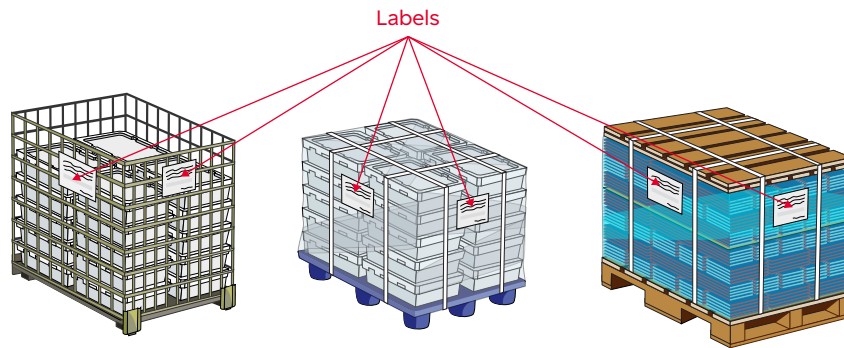

Routing Information

- the service name (Neighbourhood Mail/Courrier de quartier)
- NPS routing information, as follows:
 - facility postal code (e.g. KOA 9Z0)
 - facility name (e.g., OTTAWA)
 - province abbreviation (e.g., ON), and
 - routing designation (e.g., DCF).

We recommend that the Order number be written on the labels.

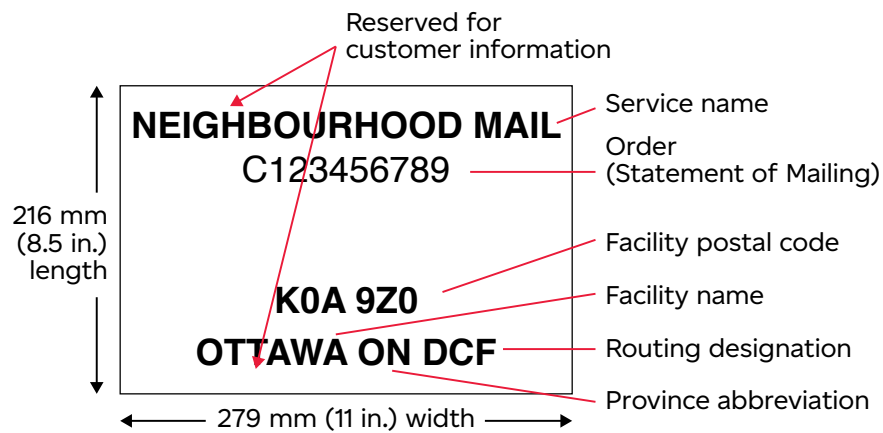



Smartmail Marketing Creating an Order

Launch a campaign and elicit a better response for every dollar of your budget



Smartmail Marketing™

Creating an Order

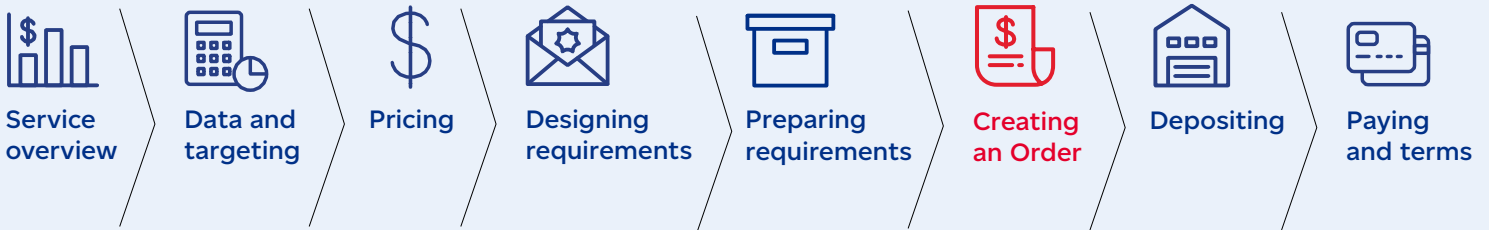

How to place an Order

Description	Personalized Mail	Postal Code Targeting	Neighbourhood Mail ¹
Creating an Order	Electronic Shipping Tools (Online and 2.0 versions)	Electronic Shipping Tools (Online and 2.0 versions)	Electronic Shipping Tools (Online, Express Order Entry [EOE] and 2.0 versions) or Precision Targeter
Order (SOM)	Machineable Mail items may be included on same SOM as Special Handling items	One order per SOM	One order per SOM
Mailing plan import file	Machineable Mail = N/A Special Handling = Mandatory	Machineable Mail = N/A Special Handling = Mandatory	Optional
Sample of mail	Mandatory	Mandatory	Mandatory
Mailing ID	N/A	Machineable: Mandatory (each PCT mailing ID is unique to each Order)	N/A
Weighted average weight	A mailing may be comprised of items of varying weights – see Appendix D for calculation instructions.	A mailing may be comprised of items of varying weights – see Appendix D for calculation instructions.	N/A

1. When you use Electronic Shipping Tools (EST) or Precision Targeter for Specified Delivery Start Date mailings, the application will calculate your deposit date based on the day of deposit (day 0) plus the number of business days required for delivery. The number of days excludes the day of mailing, weekends and statutory holidays. Weekend and statutory holiday deposits are considered deposited on the following business day.

Note: It is recommended that the number of containers is indicated on your Order.

Create your Order

An Order (Statement of Mailing) must be properly completed and transmitted electronically using the Electronic Shipping Tools (EST). Orders that are not transmitted electronically may be subject to a surcharge. Manually prepared Neighbourhood Mail Orders are subject to Non-contract prices and a Neighbourhood Mail Delivery Slip is required.

Provide a sample

You must submit for review one representative sample of each item with different physical characteristics (weight, size, content) on deposit. Otherwise, to avoid delaying or detaining the progress of mail, you agree that one sample item will be removed from the mailing for Canada Post's records and verification.

You are encouraged to have mail items verified for compliance prior to depositing them. This can be done by contacting a Commercial Service Network (CSN) Representative at 1-866-757-5480.

Mailing Summary and Mailing Details

The Mailing Summary includes general information regarding you and the presortation software used for mailing. The Mailing Details document includes a breakdown of the mail preparation and presortation information.

Canada Post and the SERP (Software Evaluation and Recognition Program) vendors have developed a file import functionality, the Presort Mailing Plan Import Program, which reduces the amount of data that you need to enter when preparing Orders.

The functionality allows you to import your Mailing Plans directly into the EST, using both the EST 2.0 and the EST Online versions. The SERP software will also generate the hard copy Mailing Summary and Mailing Details reports which will only be required upon request by us. Visit canadapost.ca/presortationsoftware for a list of recognized presortation software vendors. Information on how to create a machineable mail import file (optional) is available at canadapost.ca/est.

Partial mailing

If a mailing is deposited in more than one day:

- you must select the **Partial Mailing** option if using the EST or check the appropriate box on the manual Order.
- the total mailing cost must be declared on the Order for the entire mailing accompanying the first portion of the mailing. We will invoice you for the total mailing as declared on the Order.
- the Order, along with one representative sample of each item, must be deposited with the first partial mailing.
- each subsequent partial mailing must be accompanied by the applicable copy of the Order for the deposit location identified on the Order.
- each partial mailing must meet the minimum volume requirement:
 - Machineable Mail – 100 items
 - Special Handling Mail – 1,000 items
 - Neighbourhood Mail – complete distribution of one route; or the complete distribution to only residences, apartments, farms, businesses, or any combination, on a given route.

- all partial mailings within an Order must be deposited in full no later than 15 business days from the first deposit date.

For Neighbourhood Mail only:

- Deposit dates and associated volumes must be declared in EST when mailing Upon Receipt Neighbourhood Mail as a Partial Mailing.
 - For “Upon receipt” – transportation paid mailing
 - If a single deposit date is specified, and the mailing is deposited over multiple dates, the delivery date will be adjusted to reflect the date of the last deposit.
- Orders for partial mailings cannot be prepared and submitted using Precision Targeter applications or “Express Order Entry” version of EST.

Additional information for Neighbourhood Mail items

Additional information

Downstream Deposits

If you wish to deposit a Neighbourhood Mail mailing in more than one day and deposit at multiple locations, you should:

- enter each Downstream Deposit as a separate line when using Fully Featured (EST online or Electronic Shipping Tools 2.0) with the applicable Deposit Date, Deposit Location and associated volume
- submit one copy of the Order with the first deposit
- each subsequent deposit must be accompanied by one copy of the Order applicable for the declared deposit date and location
- be deposited in full no later than 15 business days from the first deposit date.

Orders for downstream deposits cannot be prepared and submitted using Precision Targeter applications or “Express Order Entry” version of the EST.

Version specific

If you wish to send different versions of items within a Neighbourhood Mail mailing (e.g., identical envelopes with varying content) to specific delivery routes within a delivery installation, you must ensure that each version:

- is identified with a distinct title in the **Title of Mail Piece** field on the container label
- is entered on separate lines on the Order
- is bundled and containerized separately, and
- has the Forward Sortation Area (FSA) and target area (i.e., residences, apartments, farms, businesses) printed on the item, if there are different versions per specific delivery routes.

When preparing a manual Order, you must ensure that each version:

- has its own Neighbourhood Mail Delivery Slip
- has container labels that indicate the Neighbourhood Mail Delivery Slip control number is bundled and containerized separately.

Consumers' Choice

You can target more effectively by respecting the wishes of consumers who indicate that they do not wish to receive unaddressed material. When a Canadian opts into Consumers' Choice, we will continue to deliver:

- Community newspapers
- Mailings in the public (as opposed to commercial) interest from government departments/agencies at federal, provincial, territorial, municipal levels and band councils
- Materials from Elections Canada, provincial/territorial chief electoral officers and municipal election officials (or the deputy returning officer), including material from political parties and electoral candidates during an election.

Visit canadapost.ca/precisiontargeter for the breakdown of delivery points with and without these notices. Subject to Consumers' Choice, Neighbourhood Mail items are delivered to the consumer's regular mail location (e.g., to the door, mail receptacle, community mailbox, group mailbox and/or Post Office Box).

Community newspapers

In order to be considered a community newspaper, the item must:

- be a newspaper
- meet the Neighbourhood Mail size and weight specifications
- contain a maximum ratio of 70% advertising, including all enclosures, to 30% news/editorial/community notices content
- be published not more than three times a week
- serve the community in which it is published through its news and editorial content, and this news and editorial content must be relevant to any other communities to which the paper is distributed as a community newspaper and not as a newsletter, and
- not be a newsletter intended for a special interest group or consist of a printed sheet or pamphlet containing news or information.

If the content requirement is not met, the item may qualify as Neighbourhood Mail, but is not considered as an exemption from Consumers' Choice Program (i.e., the item will not qualify for Total Points of Call).

Parliamentary mailings

Parliamentary mailings using Neighbourhood Mail may be used by members of the House of Commons to send printed matter to constituents, free of charge, up to four times in a calendar year. These mailings must consist of printed matter only.

Members of the House of Commons are entitled to Parliamentary Neighbourhood Mail beginning on the day that their election to the House is announced in the *Canada Gazette* and up to 10 days after they leave office.

All mailings must be mailed in Ottawa through the House of Commons Post Office. Additional mailings, after the first four mailings, are subject to the applicable price. Contact a Canada Post representative to obtain prices.



Smartmail Marketing Depositing

Last step in getting your brand into customers' hands



Smartmail Marketing™

Depositing

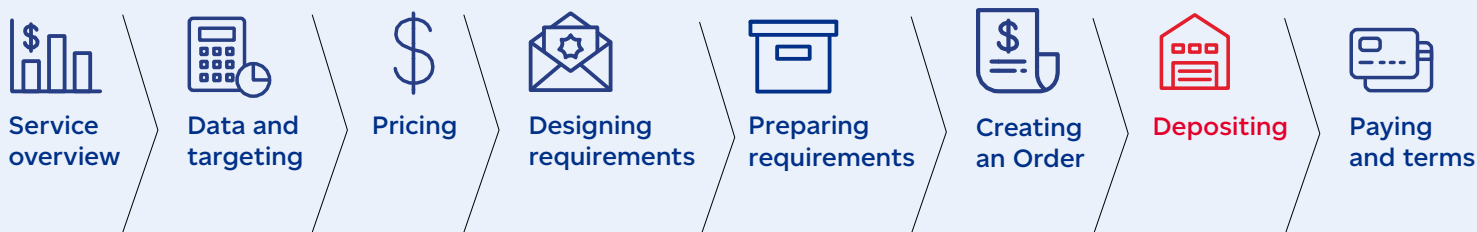

Items must be deposited in accordance with the requirements set out in the Agreement and its supporting documentation. If mail items are deposited under a particular preparation option (Machineable Mail, Special Handling and Neighbourhood Mail) and do not meet the requirements for that option, you may choose to:

- pay a surcharge, if applicable
- rework the mailing so as to meet the requirement
- have the mail processed using another option, if the items qualify, or
- use another appropriate Canada Post service.

Required at the time of deposit

Description	Personalized Mail	Postal Code Targeting	Neighbourhood Mail
One printed copy of the Order	yes	yes	yes
A sample* identical to the item being mailed (including enclosures, attachments and wrapping)	yes	yes	yes
Mailing plan (Special Handling mail must include the exportable file of mailing plans generated and imported into the EST)	yes	yes	N/A**
Postal Code Targeting Summary Report	N/A	yes	N/A

* A representative sample for each variation (weight, size, content) must be provided at the time of deposit. Otherwise, to avoid delaying or detaining the progress of mail, you agree that one sample item will be removed from the mailing for Canada Post's records and verification.

** A mailing plan is not required at the time of deposit, however no Neighbourhood Mail items weighing over 50 g may be deposited without receiving Canada Post's pre-authorization. If you intend on depositing Neighbourhood Mail items weighing over 50 g on a weekly (or more frequent) basis, you must also provide Canada Post with a mailing plan when seeking pre-authorization. See the [Designing Neighbourhood Mail](#) section for further details.

Find a Deposit Location

The Find a Deposit Location tool is available at canadapost.ca/depositlocations to help you identify the right deposit location for your mailing based on postal code, mail type and quantity. The tool will provide you more helpful information, such as the deposit location address and deposit location cut-off times.

Items deposited after the deposit location cut-off times will be considered deposited on the next business day.

Deposit location types

We have assessed the capabilities of our deposit locations to ensure they are properly equipped and capable of handling your mail efficiently and on time. The type and volume of mail which can be accepted at these facilities is outlined for each deposit location type.

Receipt verification unit (RVU)

Accept all products and all volumes with the exception of machineable mail (i.e., mail prepared in accordance with the Machineable Mail specifications). Not all RVUs can accept all types of Machineable Mail.

Commercial deposit centre (CDC)

Accept, verify, and process commercial mailings with the exception of Machineable Publications Mail (customers will be referred to the nearest RVU). Commercial mailings deposited at a CDC will continue to be processed at a Canada Post mail processing plant. Customers exceeding the maximum volumes will be referred to the nearest RVU.

Corporate post office

Accepts all commercial products except Machineable Publications Mail. Customers exceeding the maximum volumes will be referred to the nearest CDC or RVU.

Delivery facility

Accept Neighbourhood Mail for local delivery (to a maximum of full coverage for the Delivery facility).





Where to deposit your item

All items must be deposited with an authorized representative at the deposit location selected on the Order. Items cannot be deposited in street letter boxes or other mail receptacles.

Daily maximum volumes of mail apply for certain types of deposit locations.

Deposit location	Personalized Mail	Postal Code Targeting	Neighbourhood Mail
Receipt Verification Unit	No maximum	No maximum	No maximum
Commercial Deposit Centre ¹ Level 1	2 monotainers/pallets ²	2 monotainers/pallets ²	2 monotainers/pallets ²
Commercial Deposit Centre ¹ Level 2	3 monotainers/pallets ²	3 monotainers/pallets ²	3 monotainers/pallets ²
Commercial Deposit Centre ¹ Level 3	7 monotainers/pallets ²	7 monotainers/pallets ²	7 monotainers/pallets ²
Corporate Post Office ¹ Level 1	5 containers	N/A	5 containers
Corporate Post Office ¹ Level 2	12 containers	N/A	12 containers
Delivery Facility	N/A	N/A	No maximum at the delivery facility responsible for local delivery

1. Commercial Deposit Centres and Corporate Post Offices are not equipped to process mail received in monotainers or pallets that are double-stacked.

2. Not applicable for mailings requiring transportation to another delivery facility.

Note: Parliamentary mailings using Neighbourhood Mail are to be deposited only in Ottawa at the House of Commons Post Office.

When depositing Neighbourhood Mail items

You may choose between two delivery options – Specified Delivery Start Date mailings and Upon Receipt mailings.

When depositing...	Specified Delivery Start Date mailings	Upon Receipt mailings
at a Delivery Installation responsible for local delivery in an urban centre:	<ul style="list-style-type: none"> • you must deposit your mailing no later than 11:00 a.m. on the day prior to the specified delivery start date • mailings cannot be deposited earlier than 72 hours (3 business days) prior to the delivery start date 	<ul style="list-style-type: none"> • the mailings deposited by 11:00 a.m. may be delivered (subject to operation capacity) the next business day • mailings received after 11:00 a.m. may result in the delivery beginning the second business day after the deposit of the mailing
at the Non-Letter Carrier office for local delivery (including corporate offices and depots approved to accept Neighbourhood Mail):	<ul style="list-style-type: none"> • you may deposit your mailing any time on the business day prior to the delivery start date • mailings cannot be deposited earlier than 72 hours (3 business days) prior to the delivery start date 	<ul style="list-style-type: none"> • mail delivery may (subject to operation capacity) begin on the next business day
at a Drop-off Location for Canada Post to transport nationally or regionally to the local Delivery Installations:	<ul style="list-style-type: none"> • you can deposit your mailing as determined by the number of business days required by Canada Post Delivery Standards to meet the delivery start date • mailings cannot be deposited earlier than 48 hours (2 business days) prior to the determined deposit date 	<ul style="list-style-type: none"> • delivery will follow the above guidelines once it has arrived at the local delivery office

The delivery start date as indicated on the Order will be adjusted to “upon receipt” delivery for all mailings deposited earlier or later than the required times as indicated above.

Items destined for the same Canada Post Delivery Installation must be deposited on the same date. The delivery cycle start and end date will be adjusted based on the date and time that the mailing is actually received.

You may deposit mailings that include a portion for local delivery and the remaining portion requiring transportation. However, they must be prepared in separate container/shipping unit types when applicable.

If you wish to have us forward your deposited items to another delivery area, a Transportation fee will apply.



Smartmail Marketing Paying and Terms

Learning about paying and terms ensures you get the most out of your agreement with Canada Post



Smartmail Marketing™

Paying and Terms

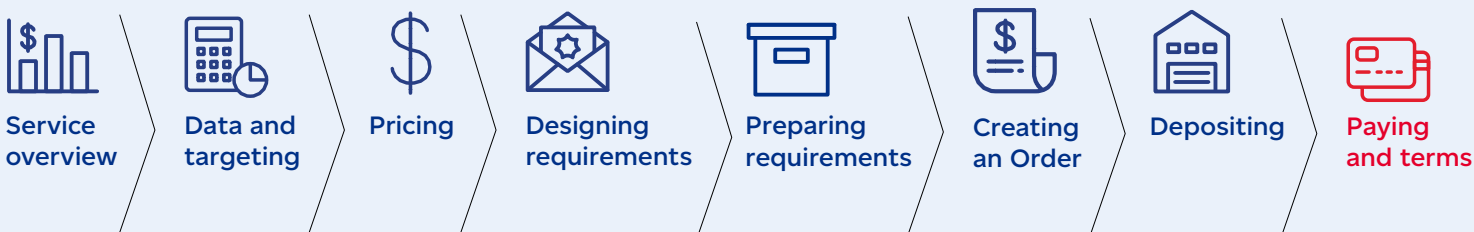

Paying for your mailing

1 Application

The information found in Paying for Your Mailing applies to the following products and services: Canada Post Personalized Mail, Postal Code Targeting and Canada Post Neighbourhood Mail.

2 Payment Method Options

The following describes various payment method options acceptable to Canada Post. However, not all options may be accepted at all Canada Post facilities.

2.1 Use of Account

2.1.1 Personalized Mail, Postal Code Targeting and Neighbourhood Mail

- A customer with pre-approved credit terms may elect “ACCOUNT” as a method of payment if the mailing is to be invoiced and charged to the customer’s Account and for applicable credit terms to apply. See [Section 3 “Pre-Approved Credit Terms – Account”](#) for details.
- Customers who do not qualify for credit terms must provide full payment at the time of mailing. Otherwise, the mailing will not be accepted. See [Section 5 “Proof of Payment and Use of Postal Indicia”](#) for details.

3 Pre-approved Credit Terms – Account

3.1 Use of Account

A customer with pre-approved credit terms may elect “ACCOUNT” as a method of payment if the mailing is to be invoiced and charged to the customer’s Account and for applicable credit terms to apply. Following approval by Canada Post and continued credit worthiness as determined by Canada Post, at its discretion, credit terms of net 15 days from date of invoice will apply.

3.2 Invoice

For Personalized Mail, Postal Code Targeting and Neighbourhood Mail, if Account was selected to pay for a mailing, Canada Post will provide the customer with an invoice that summarizes the charges posted to their account. The charges reflected on the invoice are a summary of the mailings/Orders (Statements of Mailing) that a customer has submitted to Canada Post with the following exceptions:

- a) Customers who elect to pay for services via credit card using our online tools can receive an invoice through our Invoice Notification program. Please contact Credit Management Group at 1-800-267-7651 to sign up. For more information on credit card as a payment option, see [Section 4.2 “Credit card”](#)
- b) Manual Orders (Statements of Mailing) for Neighbourhood Mail items submitted at a post office and depot (locations approved to accept Neighbourhood Mail) are not reflected on the invoice.
- c) Customers can access a copy of their invoice through our free online service. See [Section 3.6 “Manage My Accounts”](#) for further information.

Canada Post reserves the right to include on a current invoice any amount not previously billed for invoices dated 90 days prior to the date of the current invoice.

For all services, the customer should advise the Credit Management Group at 1-800-267-7651 of any discrepancies. Invoice/billing discrepancies must be brought to Canada Post’s attention within 90 days of the date of the invoice, after which time such invoice will be deemed accepted by the customer.

In the event that Canada Post is requested to respond to any invoicing discrepancy initiated by, (i), the customer or, (ii), any third-party on behalf of customer within the period mentioned above, Canada Post reserves the right to charge the customer an adjustment and/or investigation fee(s) (the investigation fees will apply in cases where Canada Post determines that disputed charges were correctly calculated on the original invoice or Order).

Canada Post reserves the right, at its sole discretion, to refuse a request for a refund or credit of charges for any Order when such request is made by any party other than the payer.

3.3 Account settlement

Accounts may be settled using one of the following:

- Pre-authorized bank payment
- Pre-authorized credit card payment, upon Canada Post approval
- Online payment (see [Section 3.6 “Manage My Accounts”](#))
- Payment by cheque or money order.

Customers wishing to sign up for pre-authorized or online payment need to complete and submit the applicable form, which can be obtained at canadapost.ca/caf or from a Canada Post Representative.

Cheques or money orders must be made payable to “CANADA POST CORPORATION”, include the Canada Post customer number and be accompanied by the remittance information. Payment must be sent to the following address:

PAYMENT PROCESSING CANADA POST
2701 RIVERSIDE DR OTTAWA ON K1A 1L7

Customers should allow up to three business days for payment processing.

3.4 Past due amounts and administration fees

3.4.1 Late Payment

Past due amounts will be subject to a late payment fee. The late payment fee will be calculated at a rate of 1.5% per month (18% per annum). Canada Post may amend the late payment fee rate at any time upon Notice to the customer.

If an amount becomes past due, Canada Post may elect to apply any money otherwise received from the customer or any money due to the customer by Canada Post toward bad debts first. Such right of set off shall be without prejudice and in addition to any other rights Canada Post may have. No interest will be paid by Canada Post on any funds held in the customer's account.

3.4.2 Account Administration Fees

Return payments: An administrative fee will be applied on any payment that is dishonoured for any reason, including a payment returned due to Non Sufficient Funds (NSF). The customer agrees to reimburse Canada Post for all costs, including legal fees and bank charges, incurred as a result of late or dishonoured payments.

Document copies: Customers requiring duplicate copies of invoices, may access them through our free online service. See [Section 3.6](#) for further information. Requests for duplicate invoices or other documentation (e.g., Order [Statement of Mailing], Packing Slips, etc.) fulfilled through our Account Management Group are subject to service fees for items up to six months from their creation date. Additional fees will apply for items older than six months, if available.

Corrections: Customers requiring corrections to Orders, invoices, or customers transmitting invalid or late electronic Orders, where Canada Post is not responsible, are subject to additional service fees.

Canada Post reserves the right to amend administration fees at any time without prior notification. A list of account administration fees is available upon customer request by contacting the Credit Management Group at 1-800-267-7651.

Investigations: In the event Canada Post is requested to investigate invoice discrepancies (including, but not limited to service guarantee failures), Canada Post may apply an additional fee for the number of disputed items submitted which Canada Post investigates and determines to be correctly charged as originally invoiced.

3.5 Statement of Account (SOA)

A Statement of Account (SOA) is provided monthly to the customer if the customer used their Account to pay for their mailing and their account was created before August 1, 2022. Statement of Account (SOA) summarizes each of the invoices processed and any related adjustments and payments made during the month, as well as any balance owing at the end of the month.

3.6 Manage My Accounts

The "Manage My Accounts" section available on our website at canadapost.ca provides a convenient and secure environment through which:

- Customers can access their account information online
- Customers may view the status of their accounts and make payment online through the "Manage My Accounts" page.

4 Payment at Time of Mailing – No Credit Terms

This section applies to Personalized Mail, Postal Code Targeting and Neighbourhood Mail.

4.1 Overview of payment method options at time of mailing

For customers without pre-approved credit terms, full payment at the time of mailing must be made by:

- certified business cheque (payment by uncertified business cheque is subject to approval by Canada Post)
- cash (post offices only)
- money order
- credit card (some conditions apply). See [Section 4.2 “Credit card”](#).
- debit card (some conditions apply)
- meter (some conditions apply). See [Section 4.3 “Postage meter”](#).

4.2 Credit card

VISA, MasterCard and American Express credit cards may be available as a method of payment option:

- when the Canada Post Electronic Shipping Tools (EST) is used and the customer chooses credit card. The credit card will be charged at the time of mailing.
- as set out in the Canada Postal Guide or other material published by Canada Post and of general application to Canada Post’s customers, as amended from time to time.

Note 1: Some conditions and restrictions apply.

Note 2: With the exception of customers enrolled for pre-authorized credit card payment, credit cards are not accepted in payment of invoices or for settlement of Account balances.

Note 3: Credit cards are accepted at Canada Post facilities only where credit card authorization facilities are available.

4.3 Postage meter

Payment by postage meter impression is an available method of payment only for the following:

Personalized Mail – Standard and Oversize Machineable 50 g and Standard Special Handling up to 100 g and Oversize Special Handling up to 50 g and Oversize Special Handling over 50 g up to 500 g – excluding Dimensional Personalized Mail.

Note 1: Payment by postage meter impression on the item cannot be used to pay for Postal Code Targeting or Neighbourhood Mail items.

Note 2: The Return to Sender service options are not available if postage meter payment is used.

The customer may elect “METER” as a method of payment for qualifying items by placing a postage meter impression on each item to sufficiently cover the cost of mailing.

Personalized Mail: Items need only the month and the year (the day can be omitted from the date stamp) shown as six numeric characters in the format YYYY.MM. The name of the service must appear to the left of the postage meter impression in English and French.

Note 1: For more information on postage meter impressions, visit [Paying For Your Mailing, “Acceptable proofs of payment”](#) of the *Canada Postal Guide*. See [Section 5 “Proof of Payment and Use of Postal Indicia”](#) for additional information.



5 Proof of Payment and Use of Postal Indicia

Personalized Mail and Postal Code Targeting items must bear the appropriate postal indicia on the addressed side of each item for all methods of payment options, unless the items are being paid using a postage meter impression – Personalized Mail items only. Payment by postage meter refers to payment by placing a postage meter impression on each item of mail qualifying for meter payment (see [Section 4.3 “Postage meter”](#)).

A postal indicia cannot be used for Neighbourhood Mail items.

Note: Postal Indicia requirements and artwork can be obtained through a Canada Post Representative or electronically at canadapost.ca/postal-indicia.

6 Authorized Users

The customer may wish to allow another party to use their Agreement or customer number. Please refer to the Agreement Activation Form and to [Section 7 “Definitions”](#) in the General Terms and Conditions. A Canada Post Representative can explain under what conditions this is possible and who may be considered as an Authorized User.



Smartmail Marketing
General Terms
and Conditions
with a Standing
Offer Agreement



Smartmail Marketing™

General Terms and Conditions with a Standing Offer Agreement

Canada Post is in the business of providing mail and other related delivery products and services. The parties wish to set out the terms by which Canada Post will provide and the Customer will use such products and services. In consideration of the mutual obligations specified in this Agreement, the parties agree to the following:

7 Definitions

7.1 “Affiliate” means an affiliated body corporate as defined by the [Canada Business Corporations Act](#) as amended from time to time.

7.2 “Agreement” has the meaning set out in [section 19](#).

7.3 “Agreement Year” means 12 consecutive calendar months falling between two anniversary dates.

7.4 “Applicable Published Prices” means, with respect to each Product and Service, the applicable prices, including any applicable fees, charges or surcharges, and less any applicable rebates, set by Canada Post and in effect at the time of mailing, as published and/or made available by Canada Post for general application to its Customers, as amended from time to time.

7.5 “Authorized User” means a party designated by the Customer and who is approved by Canada Post to have access to the Products and Services offered under this Agreement. Unless otherwise specified in this Agreement, an Authorized User has full access to the Products and Services offered under this Agreement.

7.6 “Business Day” means a day other than Saturday, Sunday, a statutory holiday and any day normally observed as a holiday by Canada Post.

7.7 “Customer-Developed/Third-Party Shipping system” means the suite approved by Canada Post, which allows for automated preparation of shipping documentation, including labels, and contains other features to facilitate shipping with Canada Post, and which is further described at [canadapost.ca/eLink](#).

7.8 “Customer Guide” means the document of the same name issued by Canada Post for each of the Products and Services, as amended from time to time.

7.9 “Electronic Goods” means electronic devices or their mechanisms, memory and all ancillary or related data storage devices, including but not limited to computers, televisions, tablets, cellular phones, smartwatches, audio equipment, media recording devices, cameras, camcorders, GPS and car audio equipment.

7.10 “Electronic Shipping Tools (EST)” means the software system made available under license by Canada Post or a third party shipping system approved by Canada Post, which allows for automated preparation of shipping documentation including labels, and contains other features to facilitate shipping with Canada Post, and which is further described at [canadapost.ca/est](#).

7.11 "Fragile Items" means items of an inherently fragile nature such as, but not limited to, glass, framed glass, mirrors, crystal, ceramics, pottery, porcelain and china, perishable items or items requiring refrigeration or temperature-controlled transport.

7.12 "Item" means a single item or mail piece prepared and mailed using one of the Products and Services in accordance with this Agreement.

7.13 "Products and Services" means any of the Products and Services, with the exception of Priority Worldwide service, offered for sale as described in the *Canada Postal Guide* or other Canada Post publication of application to commercial Customers generally, including the applicable Customer Guide.

7.14 "Subsidiary" means a subsidiary body corporate as defined by the [Canada Business Corporations Act](#) as amended from time to time.

7.15 "Term" means the period set out in the Customer Guide for each Product or Service.

7.16 Other terms not specifically defined in this Agreement have the meanings defined in the applicable Customer Guide, the *Canada Postal Guide* or other Canada Post publication of application to customers generally.

8 Canada Post's Obligations

8.1 Canada Post agrees to deliver Items of each Product and Service mailed under this Agreement according to the applicable delivery standards set out in the Customer Guide or canadapost.ca/deliverystandards and of general application to Canada Post's Customers, as amended from time to time. Unless expressly stated in this Agreement, delivery standards established by Canada Post for its Products and Services are not performance guarantees.

8.2 Canada Post agrees to provide or make available to the Customer upon execution of this Agreement, the *Canada Postal Guide* or other material published by Canada Post, including the Customer Guide corresponding to a particular Product or Service of general application to Customers, and any subsequent amendment thereto.

9 Customer's Obligations

9.1 The Customer agrees to prepare and mail Items in accordance with this Agreement.

9.2 The Customer agrees to purchase and pay for the Products and Services at the Applicable Published Prices specified in the Price Sheet, subject to any applicable rebates plus all applicable fees, charges, surcharges and taxes. The Applicable Published Prices charged are subject to verification, correction and adjustment for any applicable fees, charges, surcharges and taxes.

9.3 The Customer agrees to pay for the Products and Services purchased using the payment method(s) specified in the applicable Customer Guide.

9.4 If so specified in the Agreement, the Customer agrees to meet the minimum volume of Items required per deposit or per annual commitment for each Product and Service.

9.5 If so specified in the Agreement for a Product or Service, the Customer shall include an electronic order, in such form as approved or stipulated by Canada Post, with each mailing.

9.6 If so specified in the Agreement for a Product or Service, the Customer agrees to obtain Canada Post's pre-authorization prior to depositing any Item requiring such pre-authorization. This Section 9.6 does not limit Section 9.1.

9.7 Use of Marks and Indemnification Obligation

Except as specifically provided for in this Agreement, no party shall use any trademarks, trade names, official marks and any other rights of another party (“the Marks”) without the prior written authorization of such other party. Nothing contained in this Agreement is intended as an assignment or grant of any right, title or interest in or to the Marks. The Customer warrants that it is the owner or licensed user of the Marks, and has the authority to and does grant Canada Post and its Designated Representative the right to use such Marks as required to perform under this Agreement. Any use by the Customer of Canada Post’s intellectual property or third- party intellectual property used under licence by Canada Post, including, but not limited to usage of any Canada Post logos or trade names must be approved in writing in advance by Canada Post.

The Customer shall indemnify Canada Post from any and all claims, demands, loss or damage suffered by Canada Post and its Designated Representative as a result of, or in any way connected with the artwork (including Marks) provided by or on behalf of the Customer.

9.8 Customized Postal Indicia Use of Images

The image submitted must be suitable for family audiences.

The image cannot contain any trademarks, trade names, official marks and any other rights of another party (“the Marks”) without the prior written authorization of such other party. The Customer warrants that it is the owner or licensed user of the Marks, and has the authority to and does grant Canada Post and its agents the right to use such Mark’s as required in performing its obligations.

The Customer shall indemnify Canada Post from any and all claims, demands, loss or damage suffered by Canada Post and its agents as a result of, or in any way connected with the artwork (including Marks) provided by or on behalf of the Customer.

In the event that an image depicts one or more individuals is submitted, the customer represents and warrants that it has the permission of the individual(s) depicted to use the image. In the case of an image of a celebrity or an image that appears to have been taken without the knowledge of the individual being depicted, the customer may be asked to provide written proof of permission (by way of email or mail) to use the image.

Canada Post reserves the right to refuse any proposed Customized Postal Indicia design that it, at its sole discretion, deems unsuitable for any reason.

Items with Customized Postal Indicia are not considered postage paid and must be inducted with an Order (Statement of Mailing) at a Canada Post facility.

Customized Postal Indicia products designs are subject to change without notice.

10 Exclusive Privilege

10.1 The Customer acknowledges that Canada Post has, pursuant to and in accordance with the [Canada Post Corporation Act](#) and Regulations, the sole and exclusive privilege of collecting, transmitting and delivering letters within Canada. Without prejudicing any other rights or remedies Canada Post may otherwise have, the Customer agrees that Canada Post may terminate the Agreement if the Customer, or any Authorized User of the Customer, directly or indirectly contravenes this privilege. If the Agreement is terminated for contravention of this privilege, then, in addition to any amounts otherwise due, the Customer shall pay to Canada Post an amount equal to the difference between the amount paid or payable for all Items mailed up to the date of termination and the amount that would have been payable for that volume, at current undiscounted prices, that would have been payable, but for this Agreement.

11 Criteria for Qualification

11.1 The Customer is responsible for ensuring that all Items comply with the requirements set out in this Agreement and, except for Priority Worldwide services, the [Canada Post Corporation Act](#) and Regulations; and, for international Items, the Universal Postal Union (UPU) requirements and any receiving postal administration or designated operator requirements and the laws of the country of destination, all as may be amended from time to time. Items not complying with these requirements may not be mailed under this Agreement. Canada Post retains the right to refuse to accept any Item that it, in its sole discretion, deems unacceptable.

11.2 Mailings not previously approved by Canada Post and assessed by the Customer, or on behalf of the Customer, are subject to pricing verification and correction by Canada Post.

11.3 Items presented for mailing to Canada Post may be verified to determine compliance with applicable Terms and Conditions. Items determined not to be compliant may, at the discretion of Canada Post, be:

- a) returned at the Customer's expense, to be made compliant by the Customer, where possible;
- b) processed and charged at the next or most appropriate Product or Service category, where available;
- c) subject to a surcharge; or
- d) refused for mailing.

11.4 Canada Post may correct the Customer's order documentation if it contains incomplete or incorrect information.

11.5 Canada Post shall not be responsible for meeting any delivery standards, where applicable, for delays arising from the mailing of non-compliant Items.

12 Surcharges

12.1 Items mailed under this Agreement may be subject to one or more of the following surcharges:

- Surcharges for non-compliance with mail specification or preparation requirements;
- Fuel surcharge;
- Mailing tube surcharge;
- Oversize (OS) surcharge;
- Unpackaged surcharge;
- Non-transmitted Order surcharge;
- Non-manifested Item surcharge.

Details regarding such surcharges are set out in the applicable Customer Guide. Canada Post may amend the surcharges at any time immediately upon Notice to the Customer.

12.2 Receiving Postal Administration or Designated Surcharge

The Customer agrees to reimburse Canada Post for any incremental terminal dues costs such as, but not limited to, bulk mail and remail charges that are applied by the receiving postal administration or designated operator, as specified in the Universal Postal Union Convention.

13 Currency

13.1 Unless expressly noted to the contrary, all monetary amounts are stated and shall be paid in Canadian currency.

14 Audits

14.1 On request, the Customer shall permit Canada Post and its authorized representatives access to its premises and, if applicable, those of Authorized Users and the Mailer, On Behalf Of the Customer, during the Term, and for a reasonable period of time after the expiry or earlier termination of this Agreement. The Customer agrees to facilitate Canada Post's access, examination and audit of the records, databases and information relating to the Items mailed under this Agreement and the Customer's obligations, including, if applicable, those of Authorized Users and the Mailer, On Behalf Of the Customer, under this Agreement.

15 Authorized Users

All references to the Customer include the Customer's Authorized Users and any actions taken by an Authorized User are deemed to be the actions of the Customer. The designation of Authorized User is subject to the approval of Canada Post. The List of Authorized Users is set out in an appendix to this Agreement.

The Customer may amend the List of Authorized Users upon consent of Canada Post.

An Authorized User who ceases to be an Affiliate, Subsidiary or a franchisee of the Customer will no longer be entitled to mail Items under this Agreement as of the date upon which it ceases to be an Affiliate, Subsidiary or franchisee of the Customer. In the event that an Authorized User ceases to be an Affiliate, Subsidiary or a franchisee of the Customer, the Customer shall give Notice to Canada Post within 30 calendar days of such change in relationship.

The Customer is responsible for the compliance by each Authorized User with this Agreement. In the event that an Authorized User fails to pay for Products or Services provided under this Agreement, the Customer shall pay the amount owing.

16 Mailers, On Behalf Of

16.1 Canada Post will accept Items mailed by another party on behalf of the Customer, provided that the mailing of such Items complies with the Terms and Conditions of this Agreement. The Customer shall require a Mailer, On Behalf Of, to abide by the Agreement. The actions taken by the Mailer, On Behalf Of, are deemed to be the actions of the Customer.

17 Resale or Interlining

17.1 The Customer agrees that any Products and Services purchased under this Agreement are for the Customer's own use as an end user or for the use of an Authorized User. Unless otherwise expressly permitted by Canada Post, the Customer will not sell or permit the resale of any services or supplies received from Canada Post, nor use the Products and Services offered under this Agreement for the purposes of interlining. Interlining is the process in which a carrier uses another carrier's transportation service in the course of a continuous freight movement.

18 Assignment

18.1 The Customer shall not assign this Agreement without the prior written consent of Canada Post and any purported assignment without prior consent is void. Canada Post may assign the benefits of this Agreement or make any arrangements that would result in the performance, in whole or in part, of the obligations of Canada Post under this Agreement by a person other than Canada Post.

18.2 If the Customer amalgamates, merges or enters into a similar business combination with any other entity, including without limitation by means of

- a) acquisition of all or substantially all of the assets of another entity; or
- b) the sale of all or substantially all of the assets to another party, then, for the purpose of this Agreement, such amalgamation, merger or combination will be deemed to be an assignment requiring the prior written consent of Canada Post.

19 Entire Agreement and Alterations

19.1 All references to this Agreement shall be deemed to include:

- a) The Agreement Activation Form(s);
- b) These General Terms and Conditions;
- c) The applicable Customer Guide(s);
- d) The applicable Price Sheet(s);
- e) The Credit Application Form, if applicable;
- f) The *Canada Postal Guide*;
- g) Any appendices and any documents referenced therein;

all as may be amended from time to time.

19.2 Without limiting the generality of the above, in the event of any inconsistency between this Agreement, and any document other than the [Canada Post Corporation Act](#) or its Regulations, the terms of this Agreement shall prevail and be interpreted in the order of priority listed above.

19.3 No representations, warranties, negotiations or conditions, either verbal or written, will bind the parties except as expressly set out in this Agreement. Except as set out in the section on "[Waiver](#)" below, no agent or representative of either party to this Agreement has authority to alter the provisions of this Agreement, and any such purported alteration shall not be binding.

20 Waiver

20.1 Except as specifically stated in this Agreement, no waiver or amendment of this Agreement shall be binding unless executed in writing by the appropriate party's authorized representative. No waiver of any provision of this Agreement shall constitute a continuing waiver unless otherwise expressly provided. Acceptance of Items for mailing shall not constitute a waiver by Canada Post of the Customer's obligations under this Agreement.

21 Amendments

21.1 Canada Post reserves the right to modify, discontinue Products or Services, or otherwise amend this Agreement, including prices, by giving the Customer 30 calendar days' written Notice as specified in this Agreement.

21.2 Canada Post reserves the right to amend the *Canada Postal Guide* without Notice to the Customer.

22 Survival

22.1 The termination or expiry of this Agreement will not affect the survival and enforceability of any provision of this Agreement that is expressly or implicitly intended to remain in force after such termination or expiry.

23 Severability

23.1 If any part of the Agreement is unenforceable or invalid for any reason whatsoever, such part shall be severable from the remainder of the Agreement and its unenforceability or invalidity shall not affect the enforceability or validity of the remaining parts of the Agreement.

24 Governing Law

24.1 This Agreement is made subject to and in accordance with the [Canada Post Corporation Act](#) (the "Act"), R.S.C. 1985, c. C-10, as amended from time to time, and any of the Regulations, which are or may be from time to time made under the Act.

24.2 If the Customer's address is not in a Canadian province or territory, this Agreement shall be governed by, and interpreted under, the laws in force in the province of Ontario, Canada. The forum for any legal proceedings shall be the province of Ontario, Canada.

25 Excusable Delay

25.1 Except for the Customer's payment obligations, neither party shall be liable to the other for any failure to perform, or delay in the performance of, any obligation under the Agreement due to causes beyond its reasonable control, including, but not limited to, acts of God, epidemics, labour disruptions, failures or fluctuations in electrical power, heat, light, air conditioning or telecommunications equipment or lines, or other equipment if applicable, delays caused by customs authorities, provided that the party experiencing such circumstances immediately notifies the other party in writing of the circumstances and minimizes, to the extent reasonably practicable, the impact of such circumstances on the performance of the obligations under the Agreement.

26 Limitation of liability

26.1 Canada Post reserves the right to independently review and verify any and all claims made by the Customer arising from missed delivery and/or service commitments.

26.2 Except as specified in the *Customer Guide* for the Product or Service, Canada Post shall not be responsible for any direct, indirect, general, special or consequential damages arising out of the Agreement.

27 Termination

27.1 Either party may terminate this Agreement at any time, without cause, by giving 30 calendar days' written Notice to the other.

27.2 Either party may immediately terminate this Agreement upon written Notice to the other party if at any time during the Term:

- a) either party ceases to carry on business or makes a sale in bulk of all or substantially all of its assets; or
- b) either party becomes insolvent or bankrupt, or files any proposal or makes any assignment for the benefit of creditors; or
- c) a receiver, trustee or other person with like powers is appointed to handle the affairs or property of either party; or
- d) an order is made for the winding up or liquidation of either party; or
- e) either party continues to be in default of any of its obligations after being provided 30 calendar days' Notice of the default.

27.3 Should the Customer fail to purchase Products and Services under this Agreement for a period of more than 12 consecutive months, Canada Post may terminate the Agreement or amend the List of Authorized Users without notice.

27.4 Termination of this Agreement shall be without prejudice to any rights of the Customer or Canada Post that have accrued prior to the date of termination.

27.5 Neither party shall have a right to damages as a result of termination of this Agreement.

28 Notices

28.1 Any Notice given by either party shall be in writing and delivered personally, by Registered Mail, by Priority, by Expedited Parcel or by Xpresspost. Alternatively, Notices regarding Amendments to this Agreement by Canada Post may be sent to the Customer via email or by Canada Post posting such changes on Canada Post's website (canadapost.ca/notice), including in particular canadapost.ca/customerguides, which will be deemed received upon posting.

Notices to Canada Post shall be sent to:

AGREEMENT MONITORING
CANADA POST CORPORATION
2701 RIVERSIDE DR SUITE B0230
OTTAWA ON K1A 0B1

Notices to the Customer shall be sent to the Customer's prime contact at the mailing or email address set out in the Agreement Activation Form.

28.2 Notices delivered personally shall be deemed received at the time of delivery, Notices sent by Registered Mail and Expedited Parcel shall be deemed received on the fourth Business Day following the date of mailing, and Notices sent by Priority or Xpresspost shall be deemed received on the second Business Day following the date of mailing. Weekend and statutory holiday mailings will count as originating on the following Business Day.

28.3 Either party may change its address by giving Notice to the other party.

28.4 The Customer agrees that Canada Post may update the Customer's address information obtained from any source, including any Mail Forwarding request form submitted to Canada Post, for the purpose of contacting the Customer with respect to this Agreement.

29 Confidentiality

29.1 Except as may be required by law or for those Terms and Conditions that have been made publicly available by Canada Post, neither party nor their employees (including directors and officers) or agents shall disclose to any third party, with the exception of Authorized Users, prices or any other Terms or Conditions contained in this Agreement.

29.1.1 For clarity, Confidential Information does not include such observations and general knowledge of consumer and business trends in the purchase and sale of goods and services as a party to this Agreement may learn in providing or receiving any product or service under this Agreement and uses in the development and sale of new products and services.

29.2 Each party to this Agreement (the "Receiving Party") agrees to hold all Confidential Information of the other party (the "Disclosing Party") in confidence and not use any Confidential Information other than permitted by this Agreement. The Receiving Party shall not disclose any Confidential Information of the Disclosing Party without the prior written consent of the Disclosing Party, other than to those employees, agents, subcontractors or representatives of the Receiving Party who have a need to know such Confidential Information for the purposes contemplated in this Agreement.

29.3 Section 29.2 will not apply to any information which:

- a) is publicly available;
- b) is independently developed by the Receiving Party;

- c) is known by the Receiving Party without restriction on disclosure prior to its initial disclosure by the Disclosing Party;
- d) is lawfully received from a third party on a non-confidential basis; or
- e) is required to be disclosed by government or court order or other legal process, provided that the Receiving Party will promptly notify the disclosing Party of such requirement and will take reasonable steps to permit the Disclosing Party to prevent or limit such disclosure.

29.4 The Confidential Information shall be maintained by the Receiving Party in the same manner as the Receiving Party keeps its own Confidential Information of a similar nature and in any event shall be kept in accordance with the same care as a reasonable and prudent person would care for such Information.

29.5 Canada Post has policies and procedures in place to protect the Confidential Information and Personal Information, as defined in the [Privacy Act](#) that it handles. Canada Post is subject to the federal *Privacy Act* and the [Canada Post Corporation Act](#). Any third parties who are involved in handling Confidential Information on behalf of Canada Post are required to agree to appropriate contractual provisions.

29.6 Upon execution of the Agreement, any confidentiality obligations set out in any other agreement, relating in any way to parcel services, entered into by the parties shall be subject to these General Terms and Conditions, including, without limitation, the limitation of liability in Section D. In the event of any conflict or inconsistency between the terms and conditions of such agreement and these General Terms and Conditions, these General Terms and Conditions shall prevail to the extent of the conflict or inconsistency.

30 Language

It is the express wish of the parties that this Agreement, as well as all related documents, be written in the English language. Les parties ont demandé expressément que la présente ainsi que tout document afférent soient rédigés en anglais.

31 Ownership of mail (excludes Business Reply Mail service)

The Customer agrees that Items mailed under this Agreement will be mailed only on the Customer's or its Authorized User's behalf, and that Items will not include commingled mail, being consolidated mail of a type or from sources other than those approved by Canada Post.

Smartmail Marketing Appendices



Smartmail Marketing™

Appendix A: Brick-piled mail items

Brick-piled Mail is a way used to secure mail items without containers onto a pallet or in a monotainer. You can use pallets and monotainers for transportation (as a single unit) of mail items from your location to an approved Canada Post facility where the mail will be deposited.

What items can be brick-piled...

Description	Personalized Mail	Postal Code Targeting	Neighbourhood Mail
Special Handling Oversize and Dimensional items	yes	yes	N/A
Neighbourhood Mail Standard and Oversize items	N/A	N/A	yes

Type	Filling Shipping Units–Minimum	Filling Shipping Units–Maximum
Pallet	<ul style="list-style-type: none">for Local: height 100 mm (3.4 in.) – one rowfor Forward: height 200 mm (7.87 in.) – two rows	<ul style="list-style-type: none">Height: 1.5 m (4.9 ft.)Weight: 900 kg (1 ton) (Canada Post pallet weighs 9 kg [19.8 lb.])
Monotainer	<ul style="list-style-type: none">Mail destined within the province of deposit – 50% of the heightMail destined outside the province of deposit – 75% of the height	<ul style="list-style-type: none">Height – 1.115 m (3.65 ft.)Weight – 900 kg (1 ton)

Pallets and how to build rows on pallets or in monotainers

1. Ensure the pallet is right side up.
2. Cover the holes of the pallet with a suitable cardboard liner.
3. **First row:** place bundles of mail lengthwise along the length of the pallet or monotainer to fully cover the entire pallet. The centre of the pallet must not be left empty.

Note: Bundles cannot be strapped or bound together and each secured bundle must be loosely piled.

4. **Second row:** place bundles of mail lengthwise along the **width** of the pallet or monotainer and alternate the direction of the bundles to ensure an even and stable load during handling.
5. Pallets with loads that exceed 500 mm in height must have a cardboard liner at the halfway mark. When using a cardboard liner, face the bundles above and below the cardboard liner the same way instead of opposite length/width-wise.
 - Mail with spines: requires a cardboard liner for each new row for pallets and monotainers. Alternate the facing of spines for each row. Turn the books 180 degrees instead of 90 degrees as with other mail types.
 - Maximum height **including** base and pallet cap is 1.5 m (4.9 ft.) (pallet cap can be made of wood or sturdy paper/cardboard).
6. Completed pallets are to be capped on top of the load.
 - Monotainers do not require caps if brick-piled properly.
 - All pallets must be securely fastened and structurally sound.
7. Three layers of stretch-wrapping is to be applied around the pallet and its load, or
8. Cross-strapping is applied (metal strapping is not permitted).

Note: When the mail items are irregularly shaped or have a glossy finish and may slide around, four cross straps must be applied encompassing both the pallet cap and bottom to ensure the load is secure. For all other mailings, the four cross straps are optional, but highly recommended for additional security of all loads.

9. Completely secured pallet (Canada Post may refuse improperly secured pallets).

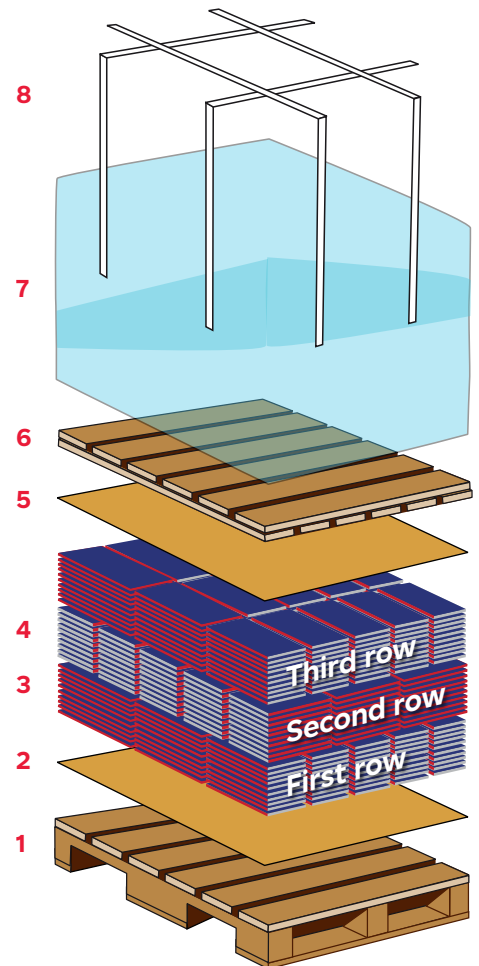
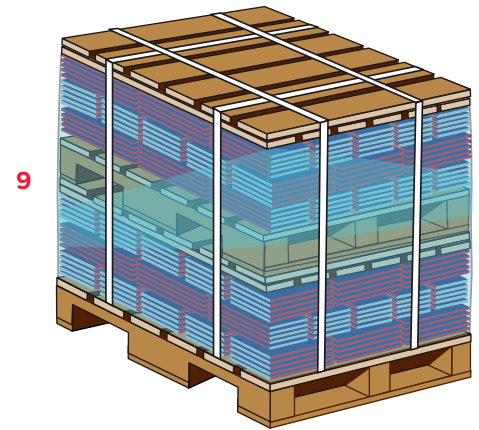

Appendix B: Pallet construction specifications

Pallet construction specifications

Pallets must conform to:

- ASTM – D1185 – [Standard Test Methods for Pallets and related Structures Employed in Materials Handling and Shipping](#)
- ISO-8611 – [Pallets for Materials Handling – Flat Pallets – Part 3: Maximum Working Loads](#)
- [Uniform Standard for Wood Pallets by National Wooden Pallet & Container Association \(USA\)](#)

Pallet must be built so the bottom deck boards do not obstruct entry by a forklift; should be accessible by a forklift on all four sides and by a hand jack on two sides.

Openings for forks must be:

- at least 102 mm (4 in.) in height on the sides of the pallet without bottom deck boards; and
- at least 89 mm (3.5 in.) in height on the sides with bottom deck boards.

Critical dimensions of mail handling equipment:

- distance across forks: maximum 686 mm (27 in.)
- distance between forks: minimum 204 mm (8 in.)
- height of the lowered fork: maximum 89 mm (3.5 in.)

Additional wooden pallet requirements

- The block design is recommended.
- Must be able to withstand temperatures of -40°C to 40°C, and severe weather conditions.
- Must not have critical defects (i.e. exposed nails, significant splits, missing wood, decay or damaged parts).
- The top surface must be flat allowing for safe loading and unloading of mail without tipping or sliding.

Appendix C: Weighted average weight

Weighted average weight

A mailing may be comprised of items of varying weights (including items above and below the base weight). In such cases, you may enter information on the Order (Statement of Mailing) using the weighted average weight per item.

Separate average weights can either be calculated by EST 2.0 or manually and entered on the Order for the following weight categories:

Categories	Size/Item	Weight category
Machineable	Standard	Up to 50 g (1.76 oz.)
	Oversize	Up to 500 g (17.6 oz.)
Special Handling	Standard	Up to 50 g (1.76 oz.)
	Standard	Over 50 g (1.76 oz.) up to 100 g (3.5 oz.)
	Oversize	Up to 500 g (17.6 oz.)
	Oversize	Over 500 g (17.6 oz.) up to 1.36 kg (3 lb.)
	Dimensional	Up to 500 g (17.6 oz.)
	Dimensional	Over 500 g (17.6 oz.) up to 1.36 kg (3 lb.)

When you enter the individual weights in the EST 2.0, the application determines the appropriate weight bands. In the Order one line is created for each weight band with the proper quantity and average weight. The Order displays both the actual weight and the calculated average weight. You still have the option to enter an average weight.

Example: A customer has a mailing of 5,000 items of Special Handling – Standard. The mailing is comprised of various weights above and below 50 g (1.76 oz.). In this example, two calculations of average weight must be completed and entered separately on the Order for pricing purposes: one entry for the portion of the mailing up to 50 g and one entry for the portion over 50 g (1.76 oz.).

Weighted average weight calculation – up to 50 g

	A	B	C	D
Special Handling	Number of items	Weight per item	Total weight	Total (C) divided by total (A) = weighted average weight
Item 1	1500	30 g	45,000 g	N/A
Item 2	500	45 g	22,500 g	N/A
Total	2000	N/A	67,500 g	33.8 g

Weighted average weight calculation – over 50 g

	A	B	C	D
Special Handling	Number of items	Weight per item	Total weight	Total (C) divided by total (A) = weighted average weight
Item 3	1000	55 g	55,000 g	N/A
Item 4	2000	60 g	120,000 g	N/A
Total	3000	N/A	175,000 g	58.3 g

Appendix D: Postal Code Targeting Orders

Creating Orders using EST online

Step 1. Select Personalized Mail service.



Step 2. Select the applicable Postal Code Targeting service from the drop-down menu.

Step 3. The Mailing ID is mandatory, it is found on your Postal Code Targeting Summary Report and is unique to each Order (Statement of Mailing).

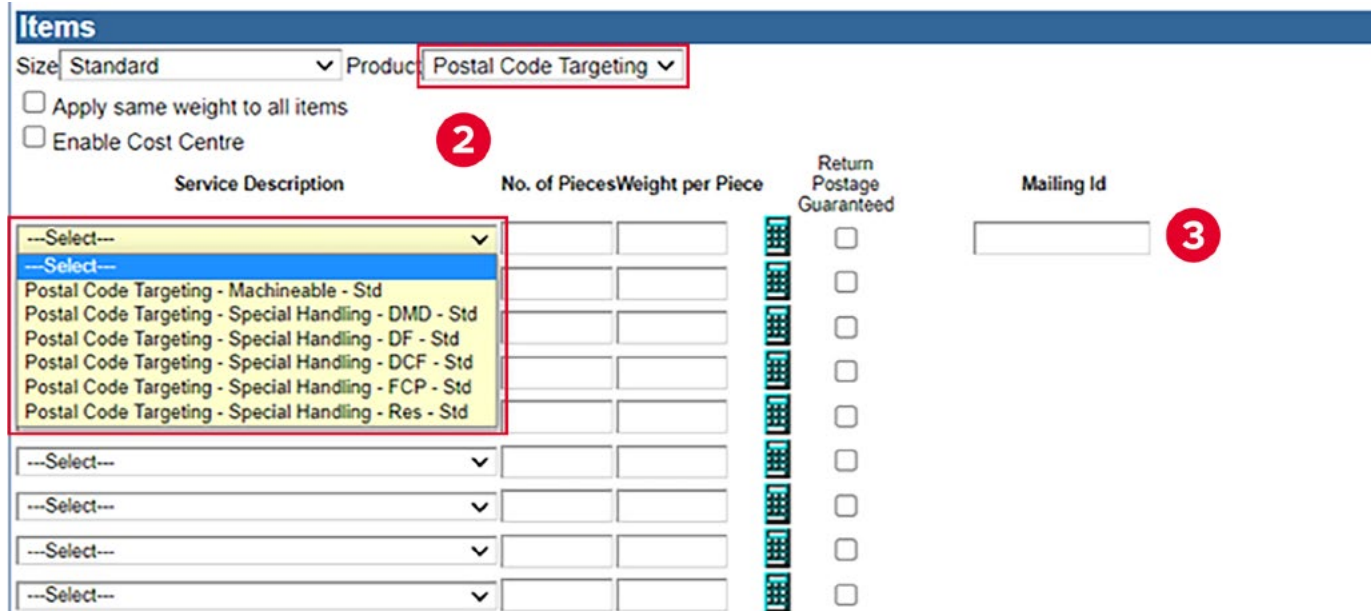

Creating Orders using EST desktop

Step 4. When you have logged in, manually enter the required fields.

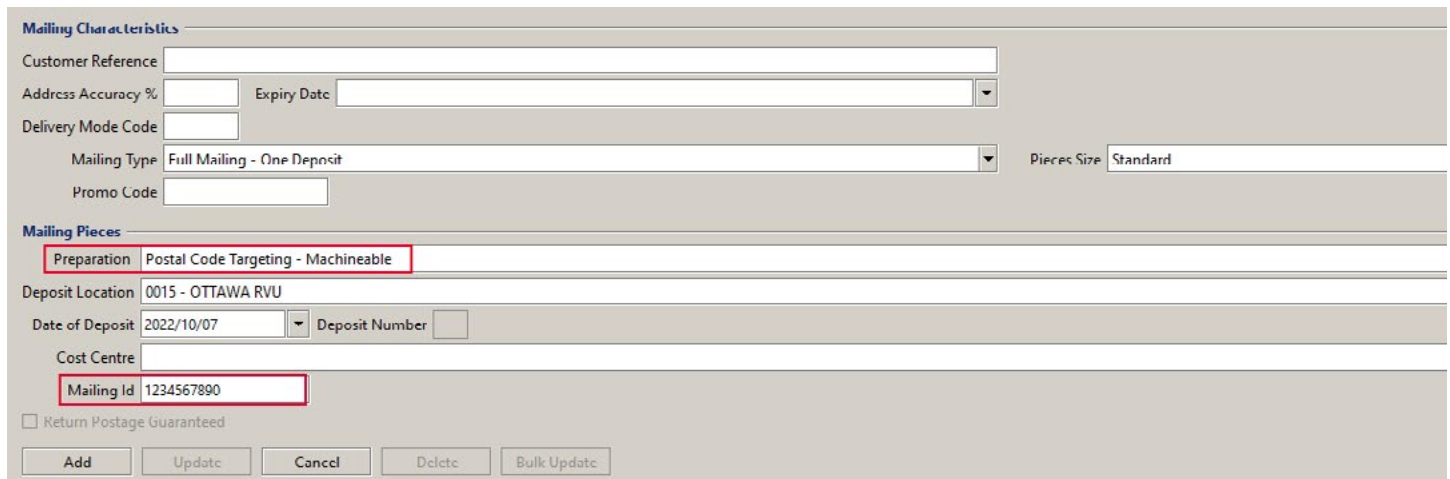

The Mailing ID is mandatory, it is found on your Postal Code Targeting Summary Report and is unique to each Order (Statement of Mailing).