



Commercial Mail Customer Guide

The Customer Guide and its amendments are available at canadapost.ca/postalguide

Effective September 23, 2023

Incentive
Lettermail™



Publications
Mail™



Business Reply
Mail™



International
Incentive
Letter-post™



Important updates

Posted on September 25, 2023	Effective on September 25, 2023		
Description of change	Location: Module	Location: Amendment/ Revision	Location: Section
Maximum weight for International Incentive Letter-post items reduced from 1,000 grams to 500 grams.	Designing	v1.2	Oversize International Incentive Letter-Post

Posted on July 14, 2023	Effective on July 14, 2023		
Description of change	Location: Module	Location: Amendment/ Revision	Location: Section
Clarified Business Reply Mail, restrictions on Mail Forwarding requests	Service Overview and Designing requirements	v1.1	Features and Options and Designing Business Reply Mail

Posted on November 21, 2022	Effective on January 9, 2023		
Description of change	Location: Module	Location: Amendment/ Revision	Location: Section
Removed pricing tables and replaced with links to price sheets.	Pricing	v1.0	Throughout section

When the document is amended or revised, the version number will be modified as follows:

- an amendment increases the first digit in the version (e.g., version 2.0, 3.0)
- a revision increases the second digit in the version (e.g., version 1.1, 1.2)
- the version number restarts at 1.0 every January of a given year.

Table of contents

Introduction	5
Process map	5
Useful links	5
Key support documents	6
How to reach us	6
Service overview	7
Commercial Mail at a glance	8
Features and options	12
Options specific to Publications Mail	13
Undeliverable Mail	16
Non-mailable Matter	16
Solicitations by mail	17
Markings	17
Pricing	18
Lettermail/Incentive Lettermail	19
Publications Mail	19
Business Reply Mail	20
International Incentive Letter-post	20
Designing requirements	25
Designing Machineable Mail – Standard items	26
Designing Machineable Mail – Oversize items	32
Designing Special Handling Publications Mail (including Delivery Facility Presort)	37
Designing bundles of unaddressed copies	41
Designing Business Reply Mail	42
Designing Machineable Mail – Standard International Incentive Letter-Post	49
Designing Machineable Mail – Oversize International Incentive Letter-Post	51



Preparing requirements	53
Preparing Machineable Mail	57
Preparing Publications Mail Special Handling	61
Preparing Publications Mail Delivery Facility Presort	71
Preparing bundles of Unaddressed copies	80
Creating an Order	81
How to place an Order	82
Depositing	85
Required at the time of deposit	86
Find a Deposit Location	86
Deposit location types	87
Where to deposit your item	87
Paying and Terms	88
General Terms and Conditions with a Standing Offer Agreement	94
Appendices	105
Appendix A: Brick-piled Mail items	106
Appendix B: Pallet construction specifications	108
Appendix C: Preparing monotainers with mixed Lettermail services	109
Appendix D: Using a spreadsheet application to sequence your Publications Mail mailing list	111
Appendix E: Weighted average weight	116



Introduction

Purpose of the customer guide

The Customer Guide is designed to give information you need to get the most from the various solutions available. It explains the qualifications, and other terms and conditions under which these services are provided. Please ensure that you are using the most current version of the guide, including all amendments, which help you meet the requirements of the service.

Process map

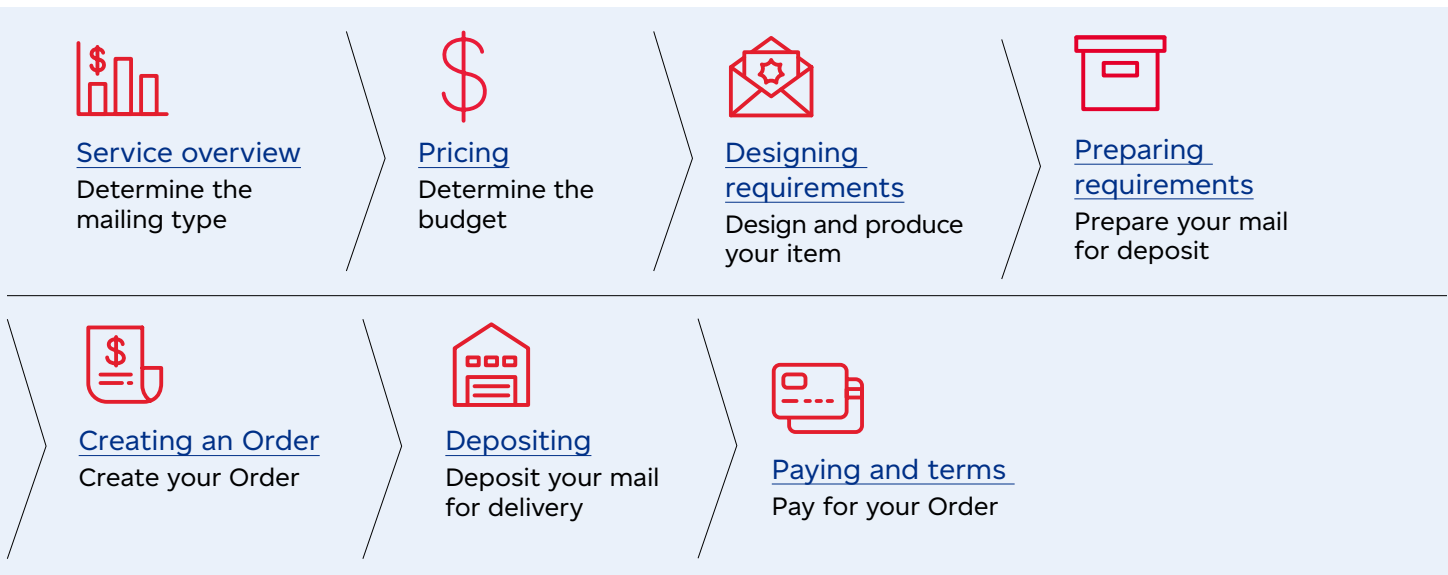

Useful links

Quick links to supporting documents and tools:

General information

Addressing guidelines canadapost.ca/addressing
Delivery standards canadapost.ca/deliverystandards
Labels canadapost.ca/labels
Non-mailable matter canadapost.ca/nonmailable
Postal Indicia canadapost.ca/postal-indicia
Customs requirements canadapost.ca/tools/pg/manual/PGcustoms-e.asp

Tools

Electronic Shipping Tools (EST) canadapost.ca/EST
Machineable Mail Advisor canadapost.ca/mmadvisor
Machineable Mail – Self-Assessment Tool
canadapost-postescanada.ca/cpc/doc/en/support/commercial-mail/machineable-mail-standard-self-assessment-tool.pdf

Additional information

[Machineable Mail](#)

Depositing mail

Deposit locations tool
canadapost.ca/depositlocations
Induction locations and cut-off times
canadapost.ca/cutofftimes

Videos

How to videos – Machineable Mail
canadapost.ca/howtovideos

Customer guides

The guide and its amendments
canadapost.ca/notice

Key support documents

Publications Mail

[Delivery Facility Presort regional price category FSA table](#)

[Distance-based pricing exceptions list for Special Handling Orders](#)

[Special Handling major deposit locations](#)

Business Reply Mail

[Artwork online tool – Demo \(video\)](#)

[Create Business Reply Mail artwork](#)

[Domestic – Size/rating template](#)

[International – Size/rating template](#)

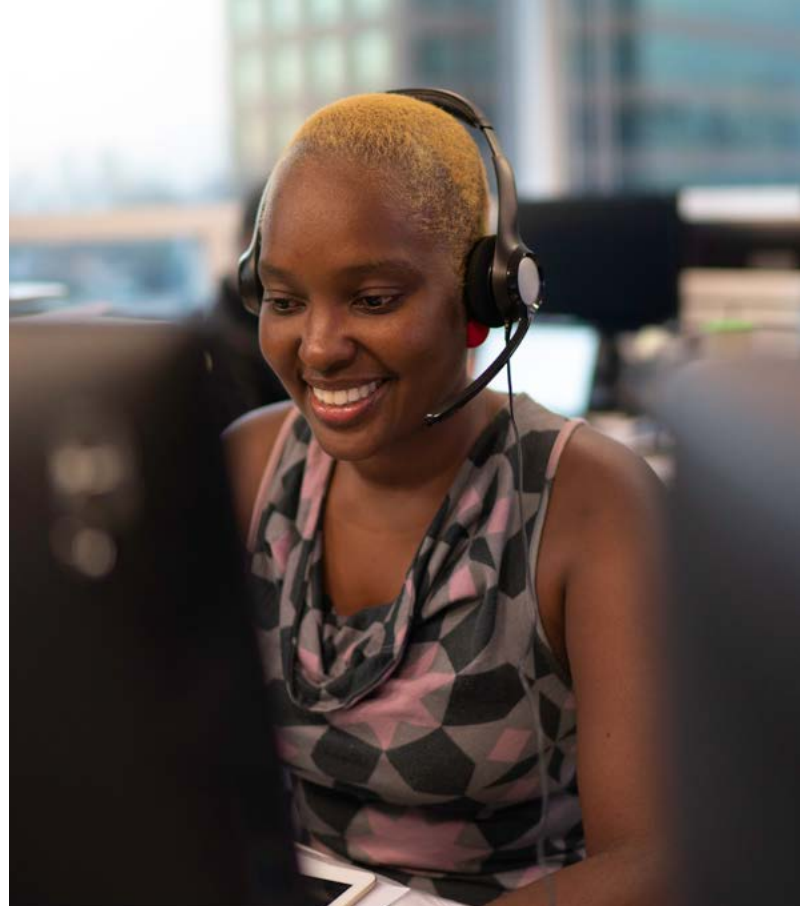

How to reach us

For enquiries regarding	Website/email	Call
General information on products and services	canadapost.ca/postalservices	Commercial Service Network 1-866-757-5480
Electronic Shipping Tools (EST)	canadapost.ca/newuser	Technical Help Line 1-877-376-1212
Payment and Account Information	cmg@canadapost.ca	Credit Management Group 1-800-267-7651

Commercial Mail
Service
overview



Commercial Mail

Service overview



Commercial Mail at a glance

Description	Incentive Lettermail™ (ILM)	Publications Mail™ (PUBS)	Business Reply Mail™ (BRM)	International Incentive Letter-post™ (IILP)
Service description	A category of Lettermail service that consists of large volumes of mail items. It's available for customers who prepare their mail according to specific requirements.	Mail items that are: <ul style="list-style-type: none"> • published and mailed at a regular frequency of at least twice a year • mailed under a valid Publications Mail Agreement number 	A direct response vehicle used by businesses, publishers, government departments, fundraisers and other organizations to seek responses from recipients (domestic and international). Customers must pay an annual, non-refundable fee and then only pay for items that are returned to them.	Provides Canadian-based mailers with a competitive service for mail destined to the United States and other international destinations.

™ Trademarks of Canada Post Corporation.

Description	Incentive Lettermail™ (ILM)	Publications Mail™ (PUBS)	Business Reply Mail™ (BRM)	International Incentive Letter-post™ (IILP)
<p>Service description</p>	<p>Mail items can include:</p> <ul style="list-style-type: none"> • letters, cards, self-mailers • annual, semi-annual or quarterly reports • receipts or invoice containing financial information • notice of voting for federal, provincial or municipal events • flexible magnet <p>Items must be deposited and paid for in Canada for delivery in Canada.</p>	<p>Mailable items, in print form, that:</p> <ul style="list-style-type: none"> • are magazines and newspapers containing news and misc. information, • are newsletters, non-promotional in nature, containing news or information relevant to a membership, special interest group or association • contain a maximum ratio of 70% advertising to 30% news/editorial (including editorial content sponsored by an advertiser) in no more than 50% of the issues in a 12-month period (enclosures and samples are not included in the 70/30 ratio). <p>Items must be deposited and paid for in Canada for delivery in Canada.</p>	<p>Mail items can include (list is not exhaustive):</p> <ul style="list-style-type: none"> • receiving payments • voting • generating sales leads • researching the marketplace • initiating customer service • developing retail trade • identifying customer needs • requesting information • building databases • renewing magazine subscriptions • raising funds • returning qualified items 	<p>Mail that is composed of paper or material with the general characteristics of paper.</p> <p>There are six categories:</p> <ul style="list-style-type: none"> • U.S.A. Premium • U.S.A. Per Item • U.S.A. Standard • International Premium • International Per Item • International Standard <p>Premium and Per Item are air mail services:</p> <ul style="list-style-type: none"> • letters, cards, postcards, self-mailers • receipts • invoices or similar financial documents <p>Standard service is an economy service (information that is not specific or relevant to the addressee):</p> <ul style="list-style-type: none"> • magazines • newspapers and newsletters • pamphlets and other promotional literature

Description	Incentive Lettermail™ (ILM)	Publications Mail™ (PUBS)	Business Reply Mail™ (BRM)	International Incentive Letter-post™ (IILP)
Unacceptable items	Commingling is not permitted. Commingling occurs when a number of separate and notably different mailings are combined to achieve the minimum deposit.	Examples of items that do not qualify as a host publication: <ul style="list-style-type: none"> • minutes of meetings • surveys • reports • books (bearing an ISBN number) • catalogues • proxies or voting ballots • invoices 	Any item that is considered non-mailable.	Mail items that: <ul style="list-style-type: none"> • do not include the service indicator • goods • films, audio or video recordings Commingling is not permitted. Commingling occurs when a number of separate and notably different mailings are combined to achieve the minimum deposit.
Minimum volume	1,000 items	Machineable: 100 items Special Handling: 1,000 items Delivery Facility Presort: at least 50 items per Order (no min. volume for Regional Rural and/ or Local Rural items)	None	100 items
Delivery standards^{1,2}	Local: 2 days Provincial: 3 days National ³ : 4 days	Local: 3 days Regional (within a province): 3-5 days National ³ (outside a province): 4-8 days Time-committed Local: 2 days Regional (within a province): 3-4 days National ³ (outside a province): 4-7 days	Local: 2 days Provincial: 3 days National ³ : 4 days	U.S.A. Premium and Per Item: 4-6 days Standard: 5-7 days International Premium and Per Item: 4-7 days Standard: 4-6 weeks
Features	<ul style="list-style-type: none"> • Mail Forwarding • Return to Sender • Return address 	<ul style="list-style-type: none"> • Mail Forwarding • Return to Sender • Return address 	<ul style="list-style-type: none"> • Mail Forwarding 	<ul style="list-style-type: none"> • Mail Forwarding • Return to Sender • Pickup

Description	Incentive Lettermail™ (ILM)	Publications Mail™ (PUBS)	Business Reply Mail™ (BRM)	International Incentive Letter-post™ (IILP)
Options	Do Not Forward	<ul style="list-style-type: none"> • Samples (not bound or affixed) • Co-packaged items • Time-committed Publications Mail 	N/A	N/A
Agreement	Not required	Required	Required	Required

1. Delivery standards are calculated from the day of deposit (day 0) plus the number of business days required for delivery. The number of days excludes the day of the mailing, weekend and statutory holidays. Weekend and statutory holiday deposits are considered deposited on the following day.
2. Estimates in business days. Delivery standards are not guaranteed. Detailed information can be found in the *Canada Postal Guide* at: canadapost.ca/deliverystandards.
3. Excludes non-major urban centres, northern regions and remote areas.



Features and options

A **feature** is part of the basic service. An **option** is a service enhancement that is not provided automatically as part of the basic service.

ILM = Incentive Lettermail PUBS = Publications Mail

BRM = Business Reply Mail IILP = International Incentive Letter-post

Features	Description	ILM	PUBS	BRM	IILP
Mail Forwarding	<p>Items that cannot be delivered as originally addressed because the addressee has moved will be forwarded to the addressee at no extra charge while there is a Mail Forwarding request in effect.</p> <p>Mail bearing the name of the addressee followed by the words “OR OCCUPANT” or similar wording, or mail bearing a non-personalized descriptor, such as “OCCUPANT”, will not be forwarded. In such cases, the item will be delivered to the original destination address.</p> <p>Note: Business Reply Mail customers must also inform the Credit Management Group of a move, whether temporary or permanent, by completing and submitting the Commercial Customer Change Request form at canadapost-postescanada.ca/cpc/doc/en/support/commercial-customer-change-request-form.pdf</p> <p>For Business Reply Mail, restrictions on Mail Forwarding requests may apply. Visit Mail Forwarding restrictions within the Features section of the <i>Canada Postal Guide</i>.</p>	yes	yes	yes	yes
Return to Sender	<p>Items that are undeliverable, or if no Mail Forwarding request is in effect, will be returned to the sender at no extra charge if a Canadian return address appears on the outside of the item. For Incentive Lettermail and International Incentive Letter-post, when the return address is on the inside of the item, it will be returned to the customer for a fee.</p> <p>For International Incentive Letter-post, this feature applies only to Premium and Per Item mailings.</p>	yes	yes	N/A	yes
Return address	<p>If a return address is used, there must be only one return address showing and it must be Canadian. Dual return addresses are also acceptable as long as there is one Canadian return address.</p> <p>Canada Post does not return items to addresses outside of Canada.</p> <p>The return address printed on the item may vary provided the mailing originates from the same mail owner (e.g. customer number must be the same on all items).</p>	yes	yes	N/A	N/A

Option	Description	ILM	PUBS	BRM	IILP
Do Not Forward	<p>Do Not Forward is an option whereby an Incentive Lettermail item will not be forwarded to the addressee, regardless if a Mail Forwarding request has been purchased. The item will be returned to the sender.</p> <p>Customers wishing to use the Do Not Forward option must:</p> <ol style="list-style-type: none"> 1. Use Electronic Shipping Tools 2.0 or the Online version of EST to add the Do Not Forward option to an Order, and 2. Apply the Do Not Forward endorsement to the front of each mail item (placed to the left and above the destination address, or in the upper left-hand corner below the return address). <p>The Do Not Forward endorsement can be downloaded from canadapost.ca/postal-indicia.</p>	yes	N/A	N/A	N/A

Options specific to Publications Mail

Options

Samples

Available option for an extra fee – Samples that are not bound or affixed to the Publications Mail item (two or more samples mounted on the same backing or packaged together are considered a single sample).

Time-committed Publications Mail

Time-committed Publications Mail is an option that provides faster delivery service when the following criteria are met:

- items deposited a minimum of 20 times per year, and are either:
 - presorted by Special Handling or Delivery Facility Presort with a minimum of 40% of each mailing being presorted direct to Delivery Facility bundles/groupings, or
 - prepared as Machineable Publications Mail.
- Time-committed “J” labels/tags are used on all containers.
- Electronic Shipping Tools (EST) is used to create the Order.

The mailing must also meet all other requirements for Publications Mail. If the requirements above are not met, your mailing will be subject to Non Time-committed delivery standards.

Enclosures included in the price of the publication

Enclosures included in the price

The following may be enclosed with, or attached to, an item of Publications Mail without payment of additional postage, other than for the additional weight of the enclosure (if applicable):

- Samples that are bound or affixed to pages within the publication
- Repositionable notes adhering to the publication or its enclosures
- Business Reply Mail item (card or envelope)
- Catalogues
- Double issues, back issues and ride-along copies originating from the same mail owner
- Publications Mail items belonging to the same mail owner.
- Any of the following items:
 - Non-personalized flyers, advertising brochures, advertorials and magalogues
 - Booklet related to the content of the publication
 - Calendars containing editorial and/or advertising
 - Reports (excluding annual or financial reports) related to the content of the publication
 - Renewal notices
 - Surveys related to the content of the publication.

Co-mingling

Publications Mail items may be commingled (co-mailed) provided:

- the mail owner is the same
- the indicia or PM number is identical on all mail items
- items within a given mailing can have different sizes, weights and thickness provided the items remain within the same weight category (see [Appendix E: Weighted Average Weight](#))
- items within a mailing can have different creative and if used, return addresses.

Two commingling options are available:

- the Publications Mail items can be packaged together within the same wrapper/envelope (co-packaging); no additional fee will apply other than for the additional weight of each enclosure; or
- the Publications Mail items (from various mailing lists) can be combined, sorted, bundled and containerized together as one mailing.



Enclosures priced separately from the publication

Enclosures priced separately

Lettermail or Personalized Mail – If an item or any of its components does not meet the requirements of Publications Mail but meets the requirements of Lettermail or Personalized Mail, it may be enclosed within a Publications Mail item but in such cases, the combined applicable postage of Lettermail or Personalized Mail and Publications Mail will apply. The following requirements apply when items are co-packaged:

- the co-packaged items must bear the applicable Postal Indicia; the indicia must not be visible on the outside of the Publications Mail item.
- a separate Order must be completed using the Electronic Shipping Tool (EST) for the enclosed Lettermail or Personalized Mail items as if they were mailed separately.
- the co-packaged option must be selected on the Publications Mail Order.
- the co-packaged item in the Publications Mail piece (co-packaged enclosure in Publications Mail) option must be selected on the Order
- Publications Mail delivery standards apply.

Co-packaged Publications Mail

Publications Mail items from different mail owners can be co-packaged but must be paid for separately.

- a separate Order must be completed using the Electronic Shipping Tool (EST) for the enclosed publication
- the co-packaged option must be selected on the Publications Mail Order.

Undeliverable Mail

Items are treated as undeliverable if:

- the item does not bear a complete and valid address
- the item is addressed to a non-existent address
- the addressee refuses the item
- delivery is prohibited by law
- the item cannot otherwise be delivered to the address.

Additionally...

For Business Reply Mail items, if the customer does not pay their annual fee or the customer cancelled their agreement.

For Publications Mail, Premium and Per Item Letter-post items, undeliverable mail items are returned at no extra charge, provided there is a Canadian return address on the outside of the mail item. Standard Letter-post items will be disposed of or recycled locally, as determined by Canada Post.

We will either dispose of or recycle Undeliverable items at our discretion.

Non-mailable Matter

Generally, non-mailable matter means any mail that:

- is prohibited by law (e.g., illegal, obscene, fraudulent)
- is non-mailable due to the fact that it fails to meet certain physical characteristics or marking requirements
- contains products or substances that could:
 - injure a person handling the mail
 - damage postal equipment or other items
 - trap other items
- contains cannabis. Refer to [ABCs of mailing](#) of the *Canada Postal Guide* for specific requirements on the promotion of cannabis.
- contains sexually explicit material unless it is sent in an opaque envelope with the words “ADULT MATERIAL” or similar wording.

For information on unacceptable items, please refer to the [Non-mailable matter](#) section of the *Canada Postal Guide*.





Solicitations by mail

Solicitations (offers) having the general appearance of a bill, invoice, or statement of account where there is no obligation to make a payment in relation to the offer unless accepted, must adhere to the regulatory obligations detailing wording and format requirements. Official requirements of the Solicitations by Mail Regulations made under the [Canada Post Corporation Act](#).

Markings

Customers may use the “Delivered by” logo on items delivered by Canada Post with the prior written consent of the Director, Marketing and Brand or her/his designate. They can be contacted at info.brand@canadapost.ca. Visit canadapost.ca/logo for available artwork.

Any unauthorized use is an offence under the *Canada Post Corporation Act* and Regulations as well as being an infringement of Canada Post’s trademarks and official marks.

An item will be considered non-mailable if, on the outside, it is marked or labelled with any of the following that were not provided or authorized by Canada Post:

- Certain markings that could be confused with Canada Post’s designators, services, or indicia. These must not be used. Some examples include:
 - any design likely to be mistaken for a postage stamp, meter impression, service label or any other mark suggesting that postage has been paid
 - any label or endorsement implying that it will be given special handling, delivered faster, such as Priority Mail, Express Mail, or be provided with any service that has not been purchased by the customer. (However, the customer may include labels on items that are directed to the addressee as an instruction that is clearly related only to the enclosure and would not otherwise result in the item being non-mailable matter. Examples of acceptable wording include “URGENT”, “RUSH” and “IMPORTANT COMMUNICATION ENCLOSED”), and
 - any facsimile of any label, endorsement or marking used by Canada Post that might cause confusion so as to affect its handling, e.g., confusion as to the service the customer has paid for.

It is your obligation to obtain approval for any proposed endorsement or other markings from Canada Post prior to printing.



Commercial Mail Pricing

Our pricing is easier than you think – More details on how it works



Commercial Mail

Pricing

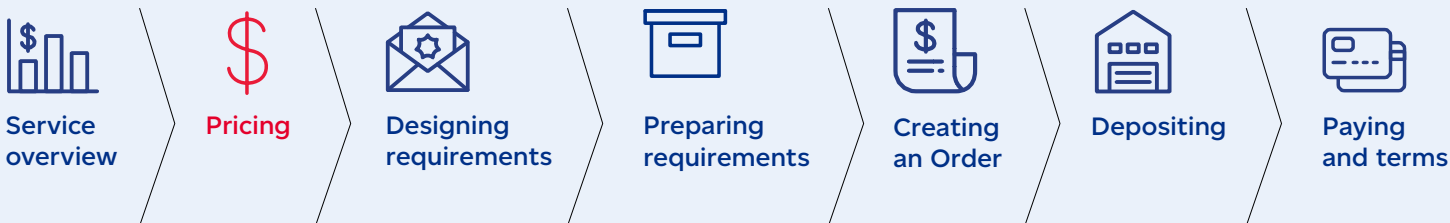

To access prices, you must meet all applicable requirements for the applicable service. Qualifying customers may have access to lower prices by signing an Agreement. All prices are subject to applicable rebates, discounts, fees, surcharges, adjustments and taxes.

Lettermail / Incentive Lettermail

To view the price sheet visit canadapost.ca/notice.

Publications Mail

To view the price sheet visit canadapost.ca/notice.

Specific for Publications Mail service

Location	Special Handling	Delivery Facility Presort
National	National prices apply to mail deposited at any approved postal facility for delivery anywhere in Canada that does not qualify as local or regional (usually outside the province).	The Delivery Facility Presort national price applies to all items mailed at a postal facility for delivery at any other postal facility in Canada. Phantom pricing applies to Delivery Facility Presort National mailings that do not meet the minimum volume requirement.
Regional/ Regional Rural	Refer to the Publications Mail Special Handling distance-based pricing exceptions list (local and regional designations).	The Delivery Facility Presort regional rural price applies to all items mailed at a postal facility for delivery at post offices that have no letter carrier delivery and that are located in the same or adjacent provinces as the accepting postal facility.

Location	Special Handling	Delivery Facility Presort
Local/Local Rural	<p>Local prices apply to mail deposited at an approved postal facility for delivery within the same city or town, with some exceptions specified in the SERP software origin-destination table.</p> <p>Note: Special Handling Local is defined differently than Delivery Facility Presort Local Rural.</p> <p>Refer to the Publications Mail Special Handling distance-based pricing exceptions list (Local and Regional Designations).</p>	<p>The Delivery Facility Presort local rural price applies to items mailed at a post office with no Letter Carrier delivery for delivery at that post office. Orders containing qualified Delivery Facility Presort Local Rural items do not have a minimum volume requirement (even if some Delivery Facility Presort National items are included on the Order).</p> <p>Note: Delivery Facility Presort Local Rural is defined differently than Special Handling Local.</p>

Specific to Publications Mail service

Bundles of unaddressed copies

The bundles of unaddressed copies price applies to bundles of unaddressed copies mailed at a postal facility for delivery at any other postal facility in Canada, and addressed to a news dealer or other bulk receiver.

Samples

A sample consists of non-printed matter or a trial-sized portion of an actual product that is used to promote a brand name, product or service. Samples can be either loose or bound/affixed to a given publication.

Loose samples

The sample price applies to “loose samples” that are included in a publication. Two or more loose samples mounted on the same backing or packaged together are considered a single sample. The weight of loose samples must not be included with the overall weight of the publication when creating the Order. Loose samples must be packaged in such a way that they do not become separated during normal handling of the mail.

Bound/affixed samples

The price per loose sample does not apply to sample(s) that are bound or affixed to pages within a publication, however the weight of these sample(s) must be included in the overall weight of the publication. All publications including sample(s) and wrapping/packaging must not exceed the maximum size and weight requirements for Publications Mail.

Business Reply Mail

To view the price sheet visit canadapost.ca/notice.

International Incentive Letter-post

To access International Incentive Letter-post prices, you must meet all applicable requirements for this service, including specifications, as well as those for mail preparation.

Contact your sales representative for your applicable International Incentive Letter-post price sheet.

ILM = Incentive Lettermail PUBS = Publications Mail
 BRM = Business Reply Mail IILP = International Incentive Letter-post

Service and description	ILM	PUBS	BRM	IILP
<p>Phantom pricing</p> <p>An amount of additional postage payable for the difference between the actual volume and the minimum volume of a mailing that does not meet the minimum volume requirement. The price charged will equal the lowest price in the category being accessed.</p> <p>Publications Mail example: 85 Machineable Mail items are deposited, when the minimum volume requirement is 100 mail items, so 15 mail items are subject to phantom pricing.</p> <p>For International Incentive Letter-post</p> <p>Regardless of destination, the phantom price for each phantom item of:</p> <ul style="list-style-type: none"> • Premium Incentive: U.S.A. Premium Incentive, “Up to 50 g”, Standard per item price • Standard Incentive: U.S.A. Standard Incentive, “Up to 50 g”, Standard per item price • Per Item Incentive: U.S.A. Per Item Incentive, “Up to 30 g”, Per item price 	yes	yes	N/A	yes
<p>Progressive pricing</p> <p>Pricing process where the item is subject to a base price plus an additional per gram charge on each item that exceeds the base weight.</p>	yes	yes	N/A	N/A
<p>Annual fee</p> <p>You will be billed an annual, non-refundable fee plus applicable taxes upon signing the Agreement Activation Form and upon renewal of the Agreement on each anniversary date. In addition, items that fail to meet the applicable specifications and requirements will be subject to surcharges or price adjustment.</p> <p>Note: Customers are responsible for payment of each returned Business Reply Mail item even if the Business Reply Mail item is blank, incomplete or empty. Canada Post will send you an invoice that summarizes the charges posted to your Business Reply Mail account. The charges reflected on the invoice are either of the annual fee and/or of a summary of the Business Reply Mail items that were returned to you.</p>	N/A	yes	yes	N/A
<p>Postal indicia</p> <p>A postal indicia is a proof of payment and located in the postage zone on a mail item (download requirements, specifications and artwork from canadapost.ca/postal-indicia).</p> <p>Basic identifying information (Publications Mail only)</p> <p>The Publications Mail (PM) Agreement number is required for proof of payment and processing. The PM number must be clearly visible, at least 6-point font, and located as follows:</p> <ul style="list-style-type: none"> • on the front or back cover, or spine if the publication is perfect bound; or • on the address label or address carrier; or • in the postage zone. 	yes	yes	N/A	yes

Service and description	ILM	PUBS	BRM	IILP
Address Accuracy program	yes	yes	N/A	N/A

Address Accuracy is a program designed to improve delivery by encouraging you to accurately address mail. Each item must have a complete mailing address, including any required suite or unit information as well as the valid postal code for that address.

Participation in the Program is mandatory for all mailings greater than 5,000 items. If the percentage on the Statement of Accuracy (SOA) produced by Canada Post – recognized software is less than 95%, we will apply an adjustment to the mailing at the time the Order is transmitted electronically using EST or deposited at Canada Post.

Address Accuracy adjustments are calculated as follows:

$$\text{Total volume} \times (95\% - \text{customer's actual Address Accuracy \%}) \times 5 \text{ ¢} = \text{total adjustment}$$

Failure to record the Address Accuracy percentage and expiry date on the Order will result in an adjustment to the cost of the mailing using the National Average Address Accuracy percentage of 56%. We encourage you to use our Data Management Services to clean and standardize your address lists while removing addresses that are undeliverable, duplicated, incorrect, or where occupants have requested to not be contacted. For more information visit canadapost.ca/datamanagementservices.

Adjustments and surcharges

As per the terms and conditions, [Section 11 “Criteria for Qualification”](#), items presented to Canada Post for mailing may be verified to determine compliance with applicable terms and conditions. Items determined to have anomalies that may result in additional handling or expense to Canada Post or that may affect our quality of service may, at the discretion of Canada Post, be:

- returned at the customer’s expense, to be reworked by the customer, where possible
- processed and charged at the next or most appropriate product or service category, where available
- subjected to a surcharge; or
- refused for mailing.

The following provides detailed information on the adjustments and surcharges that may apply to your mailings if service requirements are not met.

Adjustments

Adjustments will apply in situations where inaccuracies are noted on an Order or during processing such as:

- errors in volume, weight, or service type selected
- failure to use the Electronic Shipping Tools (EST) software when mandatory for the declared service, or
- Address Accuracy requirements are not met.

Surcharges

“Item” level surcharge

Surcharge applied to all items in a given mailing when mandatory requirements are not met. In the case of multiple mailing anomalies, only one item level surcharge will be applied.

“Order” level surcharge

Surcharge applied when Orders are not transmitted prior to deposit of mailing.

Note: Surcharges are applied to each requirement not met per service category based on the “actual” versus “declared” indicated on the Order and are invoiced with same method of payment as per the original Order. Item level surcharges under \$100 will automatically be applied at time of deposit.

5¢ Non-compliance item level surcharge

Invoice description (alphabetical order)	Description details	ILM	PUBS	BRM
2D barcode incorrect match	2D barcode information doesn't match Presort Mailing Plan.	N/A	yes	N/A
Address elements/format issues	Address elements or format did not meet the addressing requirements.	yes	yes	N/A
Address labels not secured	Labels used for address are not secured to the mail item.	yes	yes	N/A
Address slips from window	Content slipped within the window of the envelope making the address not possible to read.	yes	yes	N/A
Brick-piling issues	Brick-piling specifications have not been met.	yes	yes	N/A
BRM artwork element incorrect	One or more elements of the Business Reply Mail artwork is incorrect.	N/A	N/A	yes
BRM artwork element missing	One or more elements of the Business Reply Mail artwork is missing.	N/A	N/A	yes
BRM specs non-compliant	Business Reply Mail specifications are non-compliant.	N/A	N/A	yes
Bundle labelling issues	Bundles have been incorrectly labelled.	N/A	yes	N/A
Bundle separation issues	The method used for separating the bundles (i.e., separator cards, edgemarking) does not meet the specifications.	N/A	yes	N/A
Bundle sequencing issues	Bundles have been incorrectly sequenced within a container.	N/A	yes	N/A
Canadian Return address issues	Canadian return address is not correct, is missing or is misplaced.	yes	N/A	N/A
Container labels incorrect	Container labels do not match the content of the container.	yes	yes	N/A
Container labels missing	Container labels are missing on one or more container.	yes	yes	N/A
DMC code issues	Delivery Mode Code did not meet the standard for formatting and location, or is not valid, or is not visible.	N/A	yes	N/A

Invoice description (alphabetical order)	Description details	ILM	PUBS	BRM
Enclosure non-compliance	Enclosures or inserts do not meet the specifications.	yes	yes	N/A
IBRM artwork element incorrect	One or more elements of the International Business Reply Mail artwork is incorrect.	N/A	N/A	yes
IBRM artwork element missing	One or more elements of the International Business Reply Mail artwork is missing.	N/A	N/A	yes
IBRM specs non-compliant	International Business Reply Mail specifications are non-compliant.	N/A	N/A	yes
Items improperly sealed	Mail items not properly sealed or unwrapped items are not properly sealed to support processing.	yes	yes	N/A
Items sticking together	Mail items sticking together.	yes	yes	N/A
Mail sequencing issues	Mail sequencing specifications not met.	N/A	yes	N/A
Minimum item size not met	Mail item minimum size requirement not met.	yes	yes	N/A
Minimum item weight not met	Mail item minimum weight requirement not met.	yes	yes	N/A
Mono/pallet labels incorrect	Monotainer/pallet labels do not match the content of the container, are missing information or contain incorrect information.	yes	yes	N/A
Mono/pallet missing label	Monotainers/pallets labels are missing on one or more shipping unit.	yes	yes	N/A
Pallet size/wrap issues	Issues with the pallet size or pallet wrapping.	yes	yes	N/A
Plastic wrapper issues	Wrapper exceeds contents by more than allowable distance as per specifications.	yes	yes	N/A
Product shape non-compliance	Shape of the mail item does not meet specifications.	yes	yes	N/A
Quiet zone around add block	Quiet zone around the address block has been compromised.	yes	yes	N/A
Strapping issues	Strapping used to secure the bundles is non-compliant.	N/A	yes	N/A

The classification and amount of surcharge can change at any time immediately upon notice to you. This list is not meant to be exhaustive.

Order level surcharge (\$45.00)

Invoice description (alphabetical order)	Description details	ILM	PUBS	BRM	IILP
Non-transmitted Order surcharge	Order not transmitted prior to deposit of mailing	yes	yes	N/A	N/A

The classification and amount of surcharge can change at any time immediately upon notice to you. This list is not meant to be exhaustive.



Commercial Mail Designing requirements

Design a connected customer
experience



Commercial Mail

Designing requirements



Service overview



Pricing



Designing requirements



Preparing requirements



Creating an Order



Depositing



Paying and terms

Designing Machineable Mail – Standard items

Mandatory requirements – Publications Mail and Incentive Lettermail

Standard Items*	Length	Width	Thickness	Aspect Ratio (L/W)	Weight
Minimum	140 mm (5.6 in.)	90 mm (3.6 in.)	0.18 mm (0.007 in.)	1.3:1	2 g (0.07 oz.)
Maximum	245 mm (9.6 in.)	156 mm (6.1 in.)	5 mm (0.2 in.)	2.6:1	50 g (1.76 oz.)

* Square envelopes are acceptable, minimum 140 mm x 140 mm x 0.18 mm (5.6 in. x 5.6 in. x 0.007 in.) and maximum 156 mm x 156 mm x 5 mm (6.1 in. x 6.1 in. x 0.2 in.).

Machineability

Shape

Rectangular (square envelopes are acceptable).

Material

- Must be paper; items cannot be made or wrapped in plastic.
- Minimum paper weight for:
 - envelope: 75 gsm (approx. 20 lb. bond)
 - folded self-mailer: minimum 90 gsm (approx. 60 lb. text)
 - cards: minimum 160 gsm (approx. 60 lb. cover)
- Must be sufficiently flexible to bend; items cannot be rigid.

Enclosures

- Any paper enclosure is acceptable.
- Flexible magnets, single coin, key tags and plastic cards are acceptable when firmly attached.
- Liquids, powders and gels are unacceptable unless tested and approved by Canada Post prior to deposit.

Sealing (see [illustrated examples](#))

Envelopes: Must be closed and sealed with adhesive, with no more than 35 mm (1.4 in.) of the flap unsealed on each end.

Self-mailers: Must have the fold or continuous seal along the bottom edge.

Creative features

Items with the following features must be tested and approved by us prior to deposit:

- alternative sealing locations
- die-cuts placed along the top, leading or trailing edge
- zipper seals/perforations on the exterior items
- decorative and creative font
- non-paper enclosures within a self-mailer
- square self-mailers and cards
- tip-on placed on a card.

Once tested and approved, the service ticket # must be written on the Order at the time of deposit ([Assess your Machineable Standard or Oversize mail items](#)).

Readability

Postage zone (see [postal indicia](#))

- The indicia must be placed on the front of the item (same side as the destination address).
 - The top-right area is reserved for postage, measuring a width of 74 mm (2.9 in.) and a height of 35 mm (1.4 in.).
 - The top-right area is reserved for postage meters, measuring a width of 100 mm and a height of 35 mm (1.4 in.).
 - If the indicia is placed outside the postage zone it must be located above and to the right of the address.
-

Destination address

Each item must bear a complete address which includes an individual, company or non-personalized descriptor (e.g., “OCCUPANT”), street address, municipality, province and a valid postal code.

Address zone

Whether vertically or horizontally oriented, the complete address must appear inside the following area:

- 35 mm (1.4 in.) from the top
- 10 mm (0.4 in.) from the bottom, left and right edges.

Address labels and windows must be within the address zone.

Quiet zone

- Around the address block, leave at least 5 mm (0.2 in.) clear of text, graphics and dark colours.
- For window envelopes, ensure that the entire address remains fully visible through the window, even if the enclosure shifts within the envelope.

Return address zone

- The preferred location is on the front of the item above the address zone (35 mm [1.4 in.] from the top).
- Must be the same orientation as the destination address.
- A minimum vertical separation of 15 mm (0.6 in.) is required between the bottom of the return address and the top of the destination address.

Address fonts

Commercially available fonts should be easy to read, have well-defined characters and:

- Not overlap to the line above or below
- Not contain text effects (i.e., shadow, emboss, etc.)
- Not contain random heights within characters
- Not include calligraphy styles (i.e., *The quick brown fox jumps over the lazy dog*).

Fonts must be a dark colour (preferably black). There should be good contrast between address and background.

2D barcode requirements

The 2D barcoded Postal Indicia requirements can be found at canadapost.ca/postal-indicia

Failure to meet these mandatory requirements may result in mail delays or surcharges. Not all creative designs and sealing options are mentioned above, assessment of your physical mail item is recommended ([Assess your Machineable Standard or Oversize mail items](#)).

Additional requirements

Scented or allergen items

Ensure each item is mailable and consider the following:

- Scented items must be sealed in such a manner that prevents the scent from escaping. Similarly, liquids and powders must be packaged appropriately. A scented item produced using micro-encapsulated scent infused ink/lacquers does not need to be sealed provided the scented area is covered or contained within the mailed item.
- If an item contains a common allergen such as peanuts, sesame seeds, tree nuts (e.g., almonds, walnuts) or eggs, it must be packaged and labelled to minimize the potential for allergic reactions.

Promoting cannabis, accessories (including vaping products)

Ensure the design and content of your item is mailable, meets the requirements outlined in the [Cannabis Act](#) and adheres to the federal, provincial and territorial regulations. Detailed information can be found in [Promotion of Cannabis](#) – ABCs of mailing of the *Canada Postal Guide*.



Illustrated examples – Machineable Mail standard items

Templates to help you design envelopes, self-mailers and cards are available in our [Machineable Mail Advisor tool](#).

1 Postage zone

Measures from the upper right corner 74 mm (2.9 in.) wide (100 mm [3.4 in.] width for postage meters) by 35 mm (1.4 in.) high. The indicia must be placed on the same side as the destination address (the front).

2 Return address

The preferred return address location is on the front of the item. Measured from the upper left corner of the envelope. A minimum of 15 mm (0.6 in.) between the bottom of the return address and the top of the destination address is required.

Images are for illustration purposes only.

Horizontal orientation

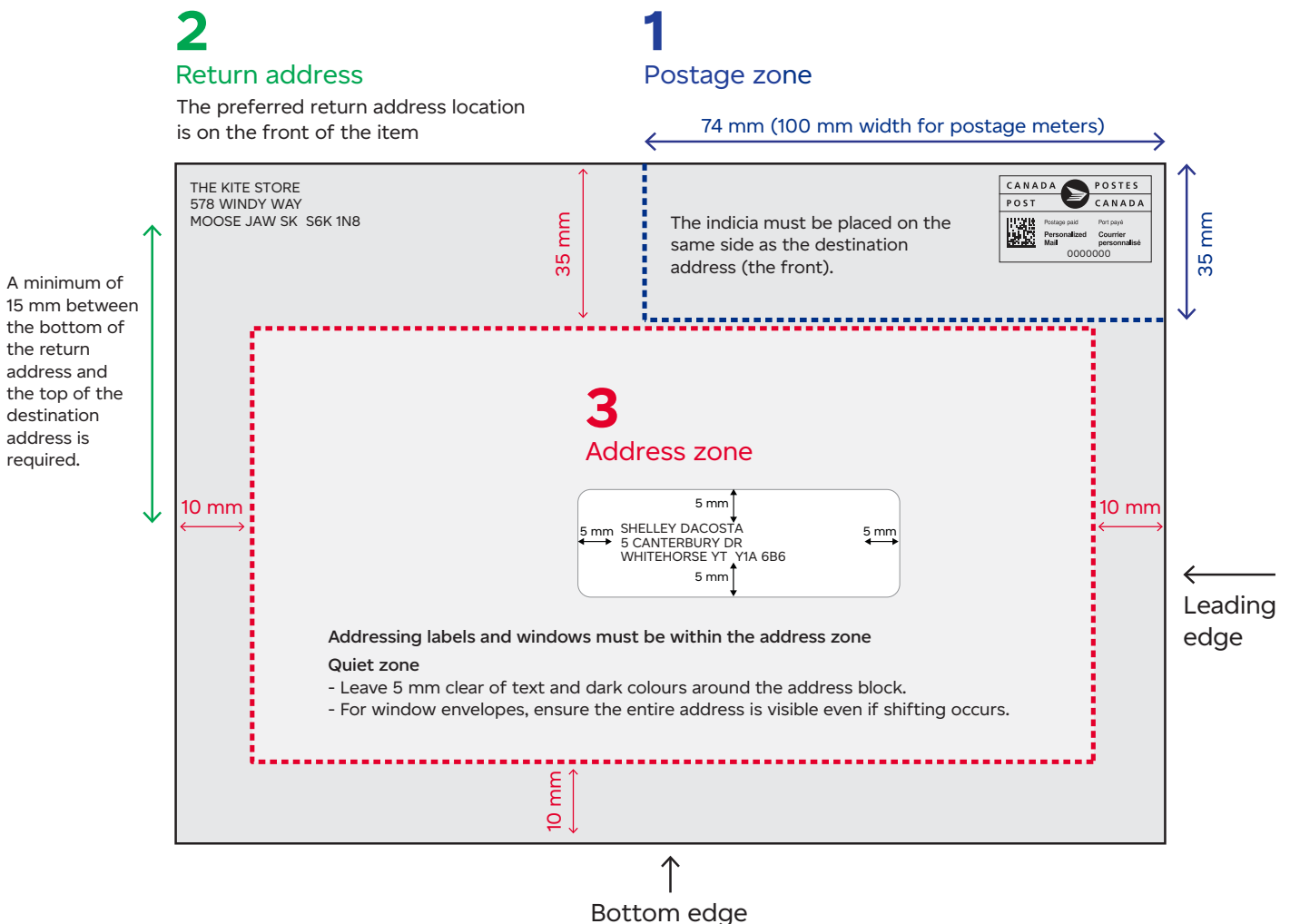

Vertical orientation

2

Return address

1

Postage zone

For vertical orientation

1 Postage zone

Located in the upper right hand corner.

2 Return address

Measures from the upper left corner.

3 Address zone

Must be 10 mm (0.4 in.) from the bottom, right and leading edges of the envelope. Leave 5 mm (0.2 in.) clear of text and dark colours around the address block.

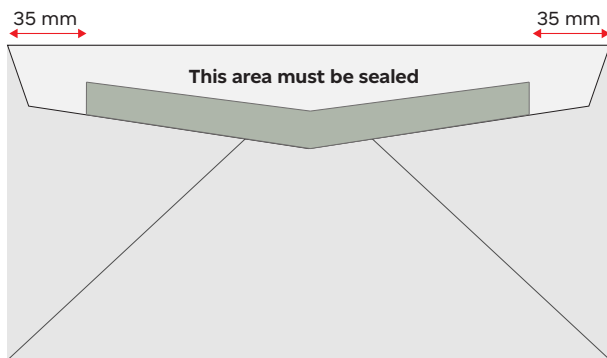
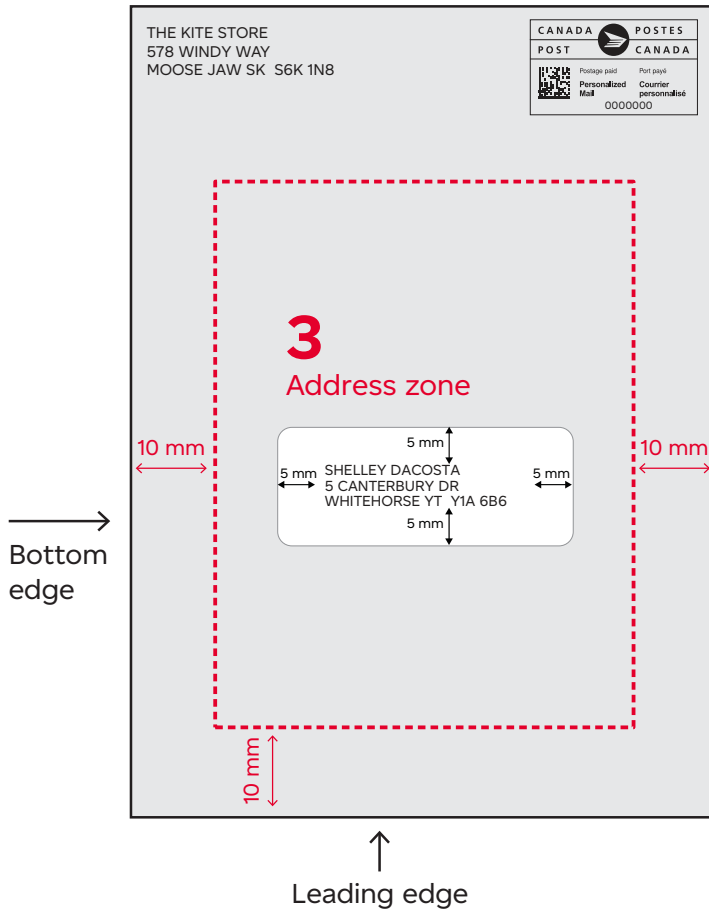

Acceptable sealing location

Envelopes must be closed and sealed with adhesive, with no more than 35 mm (1.4 in.) of the flap unsealed on each end.

To prevent envelopes from sticking together, do not apply an excessive amount of adhesive. Envelopes must not be sealed with staples, clasps or other similar devices.

Images are illustrations of acceptable sealing options.

Acceptable sealing location: Single sheet self-mailer

- Are formed by a single sheet of paper, folded once or multiple times into panels.
- Must have the fold or continuous seal along the bottom edge plus a clip/spot seal on top.

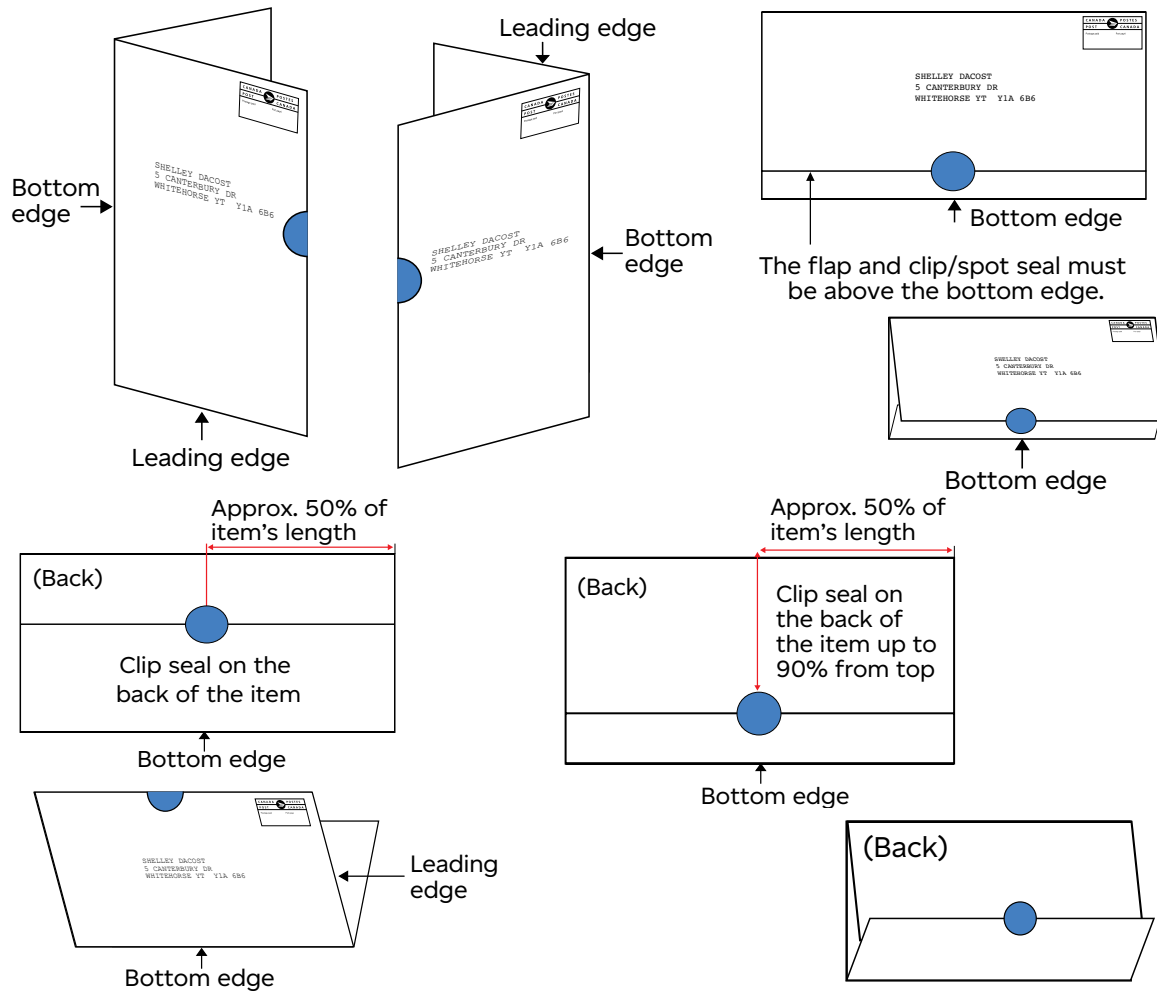

Acceptable sealing location: Multiple sheet self-mailer / mini-catalogue

- Contain multiple sheets of paper, folded once or multiple times into panels and are bound / stitched together.
- Must have the fold or continuous seal along the bottom edge and either:
 - a clip/spot seal on top and leading edge; or
 - two clip/spot seals on the leading edge.

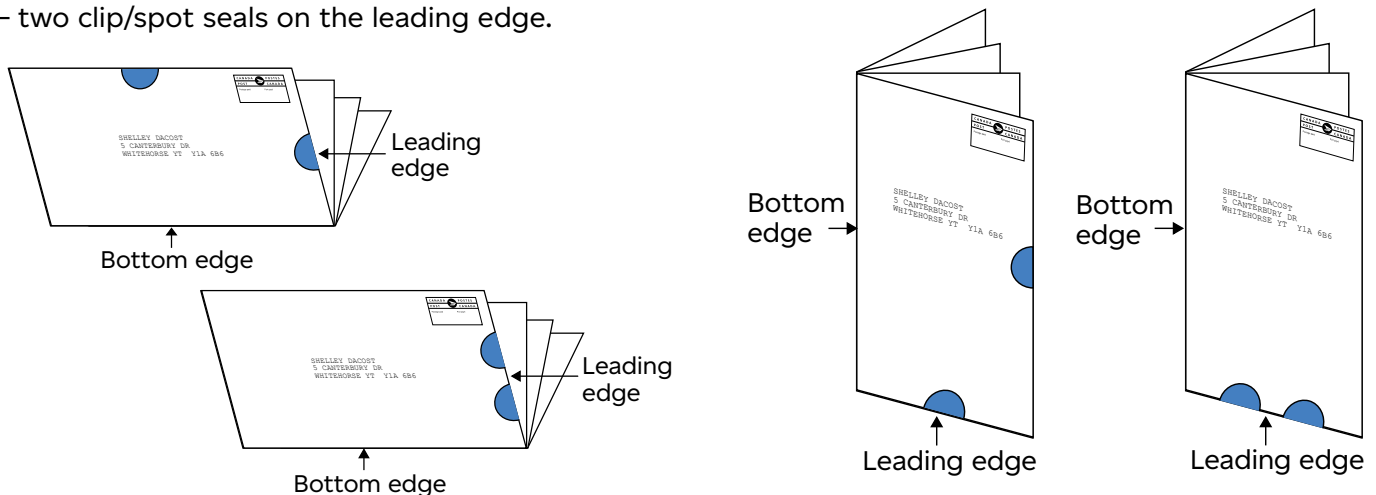

Designing Machineable Mail – Oversize items

Mandatory requirements – For Publications Mail and Incentive Lettermail

Oversize Items	Length	Width	Thickness	Weight
Minimum	140 mm (5.6 in.)	90 mm (3.6 in.)	0.5 mm (0.02 in.)	10 g (0.4 oz.)
Maximum	380 mm (14.9 in.)	270 mm (10.6 in.)	20 mm (0.8 in.)	500 g (17.6 oz.)

Machineability

Shape

Must be rectangular or square

Material

- Must be paper or plastic
- Minimum paper weight for:
 - envelope: 90 gsm (approx. 60 lb. text)
 - folded self-mailer: 90 gsm (approx. 60 lb. text)
 - card and postcard: 160 gsm (approx. 60 lb. cover)
- Minimum plastic requirements (wrapper):
 - covered with transparent or opaque material (max. haze of 75%, 159 gloss unit or less)
 - must be at least 0.03 mm thick and be low-slip coated.
- Items can be packaged in flexible or rigid material
- Items must remain horizontal when held by the edge in one hand
- Unwrapped item cover pages are strong enough to withstand machine processing without damage (at least twice as thick as the inside pages).

Enclosures

- Any paper enclosure is acceptable.
- Flexible magnets, single coin, key tags and plastic cards are acceptable when firmly attached.
- Liquids, powders and gels are unacceptable unless tested and approved by Canada Post prior to deposit.
- Enclosures within a wrapper/envelope, must closely fit the outer wrapper/envelope.

Sealing

Envelopes and wrapped items must be closed and sealed with adhesive, with no more than 35 mm (1.4 in.) of the flap unsealed on each end. To prevent items from sticking together, do not apply an excessive amount of adhesive. Envelopes must not be sealed with staples, clasps or other similar devices.

Creative features

Items with the following features must be tested and approved by us prior to deposit:

- alternative sealing locations
- tip-on placed on a card
- zipper seals/perforations on the exterior items
- die-cuts placed along the top, leading or trailing edge
- non-paper enclosures within a self-mailer
- decorative and creative font

Once tested and approved, the service ticket # must be written on the Order at the time of deposit.

Readability

Destination address

Each item must bear a complete address which includes an individual, company or non-personalized descriptor (e.g., “OCCUPANT”), a street address, municipality, province and a valid postal code.

Address zone

Whether vertically or horizontally oriented, the complete address must appear inside the following area:

- 10 mm (0.4 in.) from the bottom, left and right edges;
- for horizontal address orientation, one-quarter of the items height measured from the top edge down;
- for vertical address orientation, one-fifth of the items length measured from the edge above the address down.

Address labels and windows must be within the address zone.

Quiet zone

- Clear of text, graphics and dark colours, above the top line of the address block, leave at least 6 mm (0.24 in.); 10 mm (0.4 in.) to the left, right and below of the address block.
- For window envelopes, ensure that the entire address remains fully visible through the window, even if the enclosure shifts within the envelope.
- For Publications Mail items, the basic identifying information may be placed above the addressing information, as part of the address block, or in the area 35 mm (1.4 in.) high by 100 mm (3.4 in.) long in the upper right corner of the mail item.

Postage zone

- The top-right area is reserved for postage, measuring a width of 74 mm (2.9 in.) and a height of 35 mm (1.4 in.). (For Incentive Lettermail, 100 mm [3.4 in.] width for postage meters).
- The indicia must be placed on the front of the item (same side as the destination address).
- If the indicia is placed outside the postage zone it must be located above and to the right of the address.

Return address zone

- The preferred location is on the front of the item above the address zone (one-quarter [horizontal]/one-fifth [vertical] from the top).
- Must be the same orientation as the destination address.
- A minimum vertical separation of 18 mm (0.7 in.) is required between the bottom of the return address and the top of the destination address.

Address fonts

Commercially available fonts should be easy to read, have well-defined characters and:

- Not overlap to the line above or below
- Not contain text effects (i.e., shadow, emboss, etc.)
- Not contain random heights within characters
- Not include calligraphy styles (i.e., *The quick brown fox jumps over the lazy dog*).

Fonts must be a dark colour (preferably black). There should be good contrast between address and background.

Failure to meet these mandatory requirements may result in mail delays or surcharges. Not all creative designs and sealing options are mentioned above, assessment of your physical mail item is recommended ([Assess your Machineable Standard or Oversize mail items](#)).

Additional requirements

Scented or allergen items

Ensure each item is mailable and consider the following:

- Scented items must be sealed in such a manner that prevents the scent from escaping. Similarly, liquids and powders must be packaged appropriately. A scented item produced using micro-encapsulated scent infused ink/lacquers does not need to be sealed provided the scented area is covered or contained within the mailed item.
- If an item contains a common allergen such as peanuts, sesame seeds, tree nuts (e.g., almonds, walnuts) or eggs, it must be packaged and labelled to minimize the potential for allergic reactions.

Promoting cannabis, accessories (including vaping products)

Ensure the design and content of your item is mailable, meets the requirements outlined in the [Cannabis Act](#) and adheres to the federal, provincial and territorial regulations. Detailed information can be found in [Promotion of Cannabis](#) – ABCs of mailing of the *Canada Postal Guide*.



Illustrated example – Machineable Mail oversized items

Templates to help you design envelopes, self-mailers and cards are available in our [Machineable Mail Advisor](#) tool.

1 Postage zone

Measures from the upper right corner 74 mm (2.9 in.) wide (100 mm [3.4 in.] wide for postage meters) by 35 mm (1.4 in.) high. The indicia must be placed on the same side as the destination address (the front).

2 Return address

The preferred return address location is on the front of the item (1/4 horizontal or 25% of total width) in the top left corner. A minimum of 18 mm (0.7 in.) between the bottom of the return address and the top of the destination address is required.

Images are for illustration purposes only.

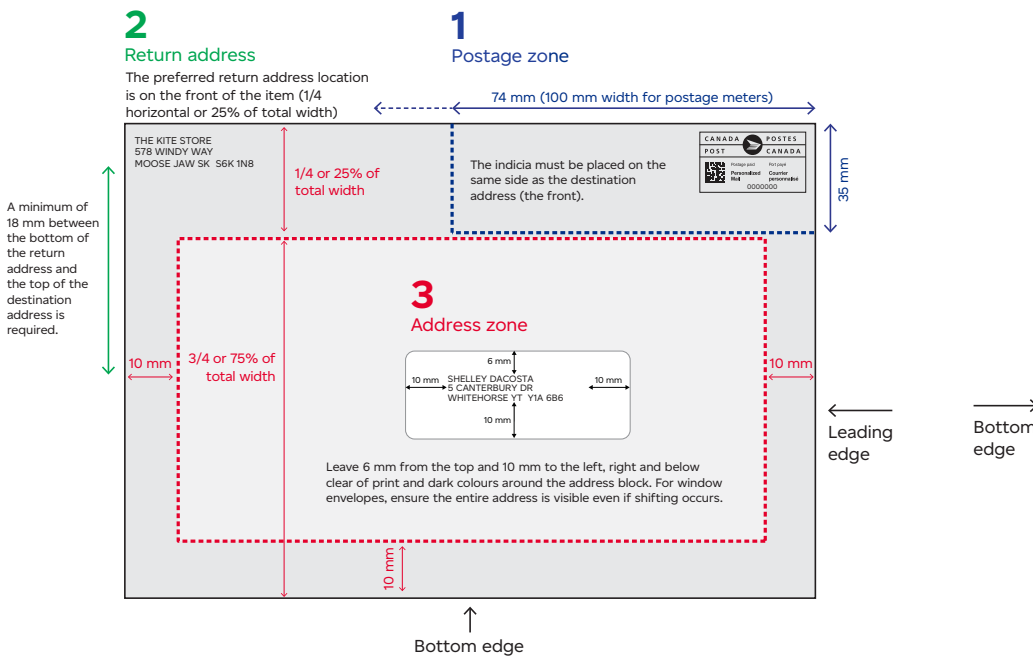

3 Address zone

Address zone for horizontal orientation, must be 10 mm (0.4 in.) from the left, leading, bottom edges of the envelope, and 1/4 or 25% from the top.

For vertical orientation the zone is 10 mm (0.4 in.) from the leading, right, bottom edges of the envelope, and from the top, 1/5 or 20% of total height.

Addressing labels and windows must be within the address zone. For the address label, leave 6 mm (0.24 in.) from the top and 10 mm (0.4 in.) to the left, right and below clear of print and dark colours around the address block. For window envelopes, ensure the entire address is visible even if shifting occurs.

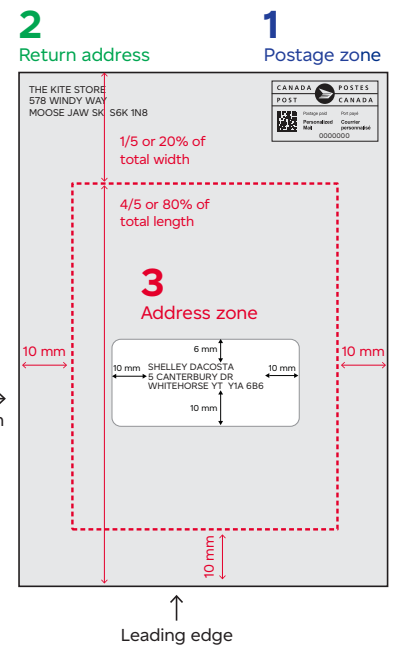

Assess your Machineable Standard or Oversize mail items

Assess your mail items before mailing

To ensure that your mailing can be processed on our machines and that your mail items meet the requirements for Machineable Mail, we offer free evaluation services. You have several assessment options.

Standard self-assessment tool

Complete your own self-assessment by using our “Standard self-assessment tool”:

- [Machineable Mail – Self-assessment tool](#).
-

Electronic sample evaluation

Contact a Commercial Service Network (CSN) representative at 1-866-757-5480 to provide an electronic sample (PDF format) of your mail item. The electronic sample must clearly show how the item will be constructed, and include:

- finished item size (e.g., length, width, thickness and approximate weight)
- paper basis weight
- fold locations (self-mailers)
- sealing location and sealing method (self-mailers and envelopes)
- window location (if applicable) and address location.

Our CSN representative may request additional testing if the electronic sample does not provide enough information. Physical approval testing is required when Creative Features are used (see the [Mandatory Requirements](#) section for details).

Physical approval testing

Customers requiring a physical test of their mail items on our mail processing equipment must send 200 samples of the final version of the mailing by calling a CSN representative at 1-866-757-5480 to obtain a service ticket number and the address to send your samples to. This process is optional, unless your mail item utilizes creative features defined in the [Mandatory Requirements](#) section.

To test readability, your mail items must be addressed. You can use the same address on all items. Any valid Canadian address is acceptable.

When 200 samples are not available for physical testing, the Mail Standards and Testing team can provide feedback on a to-scale mock-up (prototype). To have your prototype evaluated, contact the CSN at 1-866-757-5480.

Note: We cannot provide approval on a prototype. This service is meant to provide feedback on designs prior to producing 200 items for physical testing.

Designing Special Handling Publications Mail (including Delivery Facility Presort)

Mandatory requirements

Category	Size	Length	Width	Thickness	Weight
Standard	Minimum	100 mm (3.9 in.)	70 mm (2.8 in.)	0.18 mm (0.007 in.)	N/A
	Maximum	245 mm (9.6 in.)	156 mm (6.1 in.)	5 mm (0.2 in.)	100 g (3.5 oz.)
Oversize	Minimum	100 mm (3.9 in.)	70 mm (2.8 in.)	0.18 mm (0.007 in.)	N/A
	Maximum	380 mm (14.9 in.)	380 mm (14.9 in.)	55 mm* (2.2 in.)	1.36 kg (3 lb.)

*Newspaper rolls cannot exceed 130 mm (5.1 in.) in thickness.

Requirements

Shape

Rectangular or square.

Material

Minimum paper weight for:

- envelope and self-mailer: 60 gsm (approx. 16 lb.)
- card and postcard: 135 gsm (approx. 50 lb.)

Any paper type may be used for the outer covering of the mail item. The following are examples:

- coated paper
- paper containing:
 - raised or special effect printing
 - background patterns or watermarks
 - bright colours.

Transparent wrapping (recommended thickness):

- Plastic bag – at least 0.05 mm
- Plastic film – at least 0.02 mm
- Oversize items exceeding 380 mm x 130 mm (15 in. x 5.1 in.) in size should be flexible in order to fit into mail receptacles.

Enclosures

For efficient handling and processing, ensure that enclosures:

- cannot damage other mail or cause injury to postal employees (magnets, for example, must not be so strong that they cause mail items to stick to each other),
- won't tear through their envelope or wrapping during handling and delivery,
- allow efficient mail preparation, such as grouping and containerization,
- do not bear postal indicia or second destination address for another product that is visible on the outside of the mail item.

Note: In order to confirm that an enclosure is an integral part of your unwrapped mail item a “pinch test” must be performed. Place the middle of the item's fold (or spine) in the palm of your hand, between your thumb and fingers. Grasp the item tightly, and shake it back and forth (horizontally) with its open end facing downward.



Addressing

The Delivery Mode Code (DMC) must be included in the address to qualify for the Special Handling option. Requirements are listed in the “[Preparing Requirements](#)” section.

Each item must bear a complete address which includes an individual, company or non-personalized descriptor (e.g., “OCCUPANT”), a street address, municipality, province and a valid postal code.

Address zone

Whether vertically or horizontally oriented, the complete address must appear inside the following area:

- at least 10 mm (0.4 in.) from all the edges of the mail item
- to the right and below the return address when a return address is used
- outside the recommended return address zone when there is no return address
- on the same side as the indicia
- to the left of the indicia and NOT above it
- at least 10 mm (0.4 in.) from the indicia.

On wrapped or unwrapped items

Ensure that the destination address is completely visible and it must appear on or in the transparent wrapper, on the sleeve or on the insert and be located at least 10 mm (0.4 in.) from all edges.

Magazines

The destination address may be positioned parallel (horizontal address orientation) or perpendicular (vertical address orientation) to the longest edge of the magazine.

Note: For Publications Mail items the Basic Identifying Information may be used in lieu of the postal indicia.

Postage zone

The indicia may be placed anywhere on the front of the item provided that it can easily be identified, to the right of the destination address and NOT below it and at least 10 mm (0.4 in.) from the destination address.

Return address zone

The return address, if present, must be the same orientation as the destination address and clearly visible on or through the wrapper. It may appear on either the front (the address side) or the back of the item.

Non-paper enclosures (examples, list is not exhaustive)

- CDs and DVDs
- coins
- magnets
- foodstuffs/product samples
- pens and pencils
- jewellery
- keys
- plastic cards
- seeds
- video-in-print/digital advertising

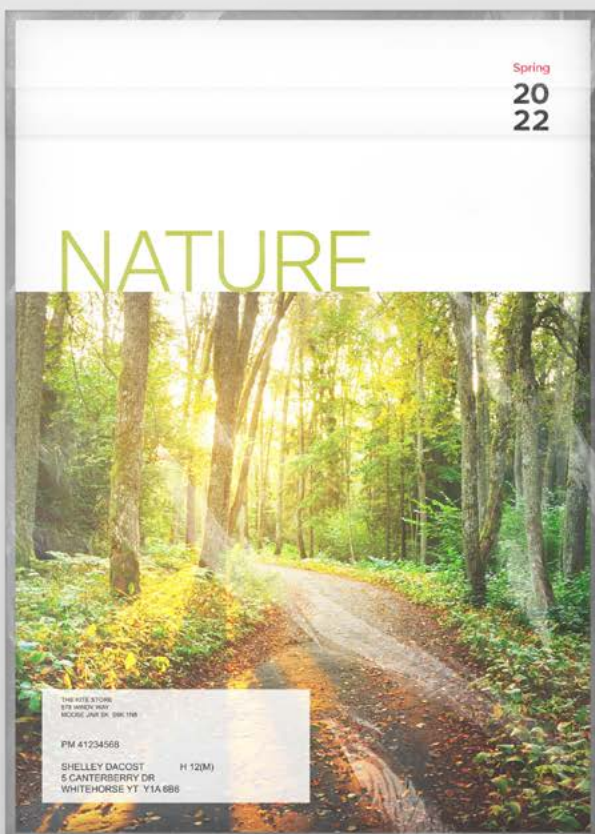

Illustrated example – Special Handling

1 Postage zone

Measures from the upper right corner 74 mm (2.9 in.) wide by 35 mm (1.4 in.) high. The indicia must be placed on the same side as the destination address (the front).

2 Return address

Return address may be printed either on the front or back of the item. On front: with 35 mm (1.4 in.) from top and 74 mm (2.9 in.) away from leading (right) edge.

3 Address zone

Address zone is at least 10 mm (0.4 in.) from all edges and 10 mm (0.4 in.) from the indicia. The destination address must be to the right and below the return address or to the left of the indicia and NOT above it.

Addressing labels and windows must be within the address zone. For the address label, leave 3 mm (0.1 in.) from the top, left, right and below clear of print and dark colours around the address block. For window envelopes, ensure the entire address is visible even if shifting occurs.

Images are for illustration purposes only.

2

Return address

Return address may be printed either on the front or back of the item. On front: with 35 mm from top and 74 mm away from right edge.

1

Postage zone

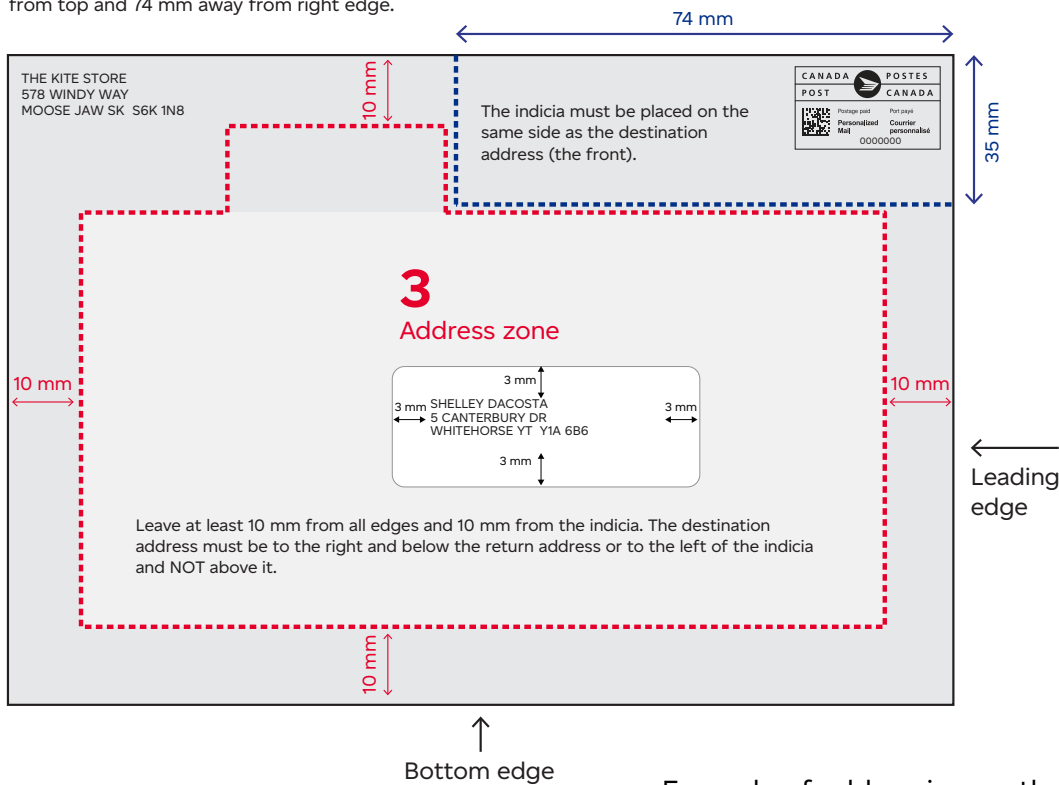

Example of addressing on the address label on a magazine.

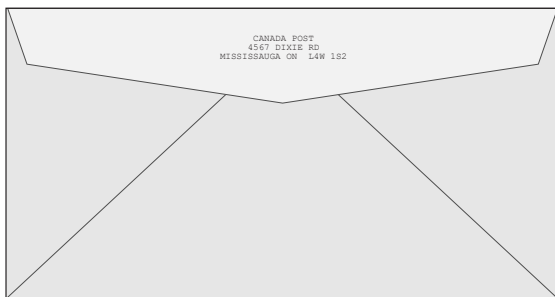



Designing bundles of unaddressed copies

Mandatory requirements (including all enclosures and wrapping)

Publications Mail only

Category	Size	Length	Width	Thickness	Weight
Per bundle	Min.	140 mm (5.6 in.)	90 mm (3.6 in.)	0.36 mm (0.014 in.)	N/A
	Max.	600 mm (23.6 in.)	600 mm (23.6 in.)	600 mm (23.6 in.)	22.7 kg (50 lb.)

Designing Business Reply Mail

What to keep in mind when creating your item

It is important that items submitted meet the content, format and physical characteristics specified.

Domestic Business Reply Mail

Machineable	Size	Length	Width	Thickness	Aspect ratio (L/W)	Weight
Standard envelopes	Min.	140 mm (5.6 in.)	90 mm (3.6 in.)	0.18 mm (0.007 in.)	1.3:1	2 g (0.07 oz.)
	Max.	245 mm (9.6 in.)	156 mm (6.1 in.)	5 mm (0.2 in.)	2.6:1	50 g (1.76 oz.)
Standard cards	Min.	140 mm (5.6 in.)	90 mm (3.6 in.)	0.18 mm (0.007 in.)	1.3:1	N/A
	Max.	235 mm (9.2 in.)	120 mm (4.7 in.)	5 mm (0.2 in.)	2.6:1	50 g (1.76 oz.)

Non-Machineable	Size	Length	Width	Thickness	Aspect ratio (L/W)	Weight
Other (non-standard and oversize) envelopes	Min.	140 mm (5.6 in.)	90 mm (3.6 in.)	0.18 mm (0.007 in.)	N/A	10 g (0.4 oz.)
	Max.	380 mm (14.9 in.)	270 mm (10.6 in.)	20 mm (0.8 in.)	N/A	500 g (17.6 oz.)

Note: You must use leak-proof plastic commercial envelopes that meet our domestic Business Reply Mail service specifications. You require a leak-proof container as part of the response from the recipient when returning duck wings and goose tails by hunters and other “flat” objects (Items must be 20 mm [0.8 in.] or less in thickness and meet applicable requirements for Other [Oversize] Business Reply Mail). For information on mailing liquid and dry patient specimens, refer to [Liquid and dry patient specimens \(human or animal\)](#) in the ABCs of Mailing of the *Canada Postal Guide*.

Physical samples must be submitted to us to ensure the plastic commercial envelopes and intended contents qualify for the domestic Business Reply Mail service. For more information, refer to [Assess your Machineable Standard or Oversize mail items](#).

International Business Reply Mail

Machineable	Size	Length	Width	Thickness	Aspect ratio (L/W)	Weight
Standard envelopes	Min.	140 mm (5.6 in.)	90 mm (3.6 in.)	0.18 mm (0.007 in.)	1.4:1	3 g (0.11 oz.)
	Max.	245 mm (9.6 in.)	156 mm (6.1 in.)	5 mm (0.2 in.)	2.6:1	50 g (1.76 oz.)
Standard cards	Min.	140 mm (5.6 in.)	90 mm (3.6 in.)	0.18 mm (0.007 in.)	1.4:1	N/A
	Max.	235 mm (9.2 in.)	120 mm (4.7 in.)	5 mm (0.2 in.)	2.6:1	50 g (1.76 oz.)

Any International Business Reply Mail item exceeding the size and weight dimensions will be returned as International Letter-post and will be subject to the applicable weight category at the Other Letter-post price.

Domestic and international labels

Labels can be attached only to envelopes and cards. Both labels include the 4-state barcode. Canada Post is responsible for providing the artwork for the overlay labels.

Category	Length	Width
eLabels (with indicia, chevrons, extraction bar, address and barcode)	135 mm (5.3 in.)	72 mm (2.8 in.)
Overlay labels (with address and barcode)	101 mm (4.0 in.)	50 mm (2.0 in.)

1. eLabels – provides you the opportunity to use an electronic channel (i.e., website, email) to facilitate a hardcopy response (i.e., BRM envelope).
2. Overlay labels – provides you the opportunity to efficiently recycle outdated Business Reply Mail envelopes and cards.

Mandatory requirements – Business Reply Mail

Machineability

Shape

Rectangular

Material

Must be paper; items cannot be made or wrapped in plastic.

- Minimum paper weight for:
 - envelope: 75 gsm (approx. 20 lb. bond)
 - card and postcard: min. 160 gsm (approx. 60 lb. cover) but not less than 111 gsm (approx. 40 lb. cover)

Note: Optimal card size of 165 mm x 108 mm (6.5 in. x 4.2 in.); and paper grain direction long.

- Must be sufficiently flexible to bend; items cannot be rigid.

Window envelopes (domestic mailings only)

- Ensure that the entire address remains fully visible through the window, even if the enclosure shifts.
- Ensure that all windows are covered with transparent material.
- Best practices for optimal processing – the transparent material used to cover the window has:
 - enough transparency to allow visibility with a maximum haze of 75%
 - uniform clarity
 - no wrinkles, creases or blemishes
 - a gloss reading (on the side facing out) of 159 gloss units or less.

Enclosures (domestic mailings only)

Coins – provided they are:

- no larger in size or weight than the Canadian 25-cent coin
- firmly attached to the insert with glue or adhesive to prevent any movement
- positioned between 35 mm (1.4 in.) and 85 mm (3.3 in.) up from the bottom edge and 25 mm (1 in.) in from the left and right edges of the envelope; and outside the postage zone.

Any window(s) used in envelopes to make the coins visible must be covered by a transparent material. The final item, including enclosures (or content), must measure 20 mm (0.8 in.) or less in thickness.

Sealing

Envelopes must be closed and sealed with adhesive. To prevent envelopes from sticking together, do not apply surplus adhesive. Envelopes must not contain staples, clasps or other similar devices.

Readability

Printing

The Business Reply Mail Artwork Online tool provides artwork in encapsulated postscript file (EPS, vector outline format) and portable document format (PDF). The artwork is designed to work with Adobe® Creative Suite® and QuarkXPress™ version 4.1 (or later).

To enquire about using alternate software, contact a Customer Service Network (CSN) Representative.

Using QuarkXPress*, Adobe InDesign® and Adobe Photoshop®**:

- The artwork for Business Reply Mail should be printed using the EPS file. The PDF file should only be used for reviewing artwork.
- The artwork should be printed at 100%.
- Positives or negatives should be printed using the highest quality printer settings. Ensure that there are adequate levels of toner or ink before printing positive or negatives. Without adequate levels, the extraction bars, barcode, and address block may be unreadable.

* When printing from QuarkXPress (for Microsoft Windows™ OS) to a non-PostScript printer, select Full Resolution Preview Resolution.

**When opening the EPS file using Photoshop, ensure the resolution is set to 600 dpi (dots per inch), the Mode is set to Grey Scale, the Orientation is set to portrait and the Constrain Proportions box is checked.

Addressing

The Business Reply Mail address and postal code must adhere to the addressing guidelines at canadapost.ca/addressing.

Customers may only modify the first line (title, logo) and, depending on the size of the item, a second line (name) may be available for customizing. When customizing the first line (title, logo) or second line (name), customers are not permitted to change addressing information.

The Business Reply Mail customer must be the mail owner/mail receiver of the BRM return address.

®Adobe, Creative Cloud, InDesign and Photoshop are registered trademarks of Adobe Inc.

™ QuarkXPress is a registered trademark of Quark Software Inc. Microsoft Windows is a registered trademark of Microsoft.

Multiple BRM agreements at a shared address (including virtual offices) are acceptable, however restrictions on Mail Forwarding requests apply. Visit Mail Forwarding restrictions within the Features Section of the *Canada Postal Guide*.

The Business Reply Mail address and postal code provided are specific to the Business Reply Mail service. Do not use on any other mail items.

Fonts (Canadian standards)

Font type	Font size	Maximum address length	
		Envelope size, #8	Envelope size, #8.5
Courier New	12	22 characters	24 characters
Courier New Bold	10	26 characters	29 characters
Letter Gothic	10	26 characters	29 characters

Barcode

The artwork contains a 4-state barcode with the human-readable line located above the barcode. There should be 52 bars in the barcode, consistent in width and spacing. The bars on the barcode should be crisp (no ghost images or blurring). Do not alter the barcode

Ink

Black. Fluorescent inks may not be used on domestic or International Business Reply Mail items.

Crop marks

The artwork contains several crop marks. The crop marks identified by TL, BL, TR and BR represent the corners of the artwork.

- TL = top left
- BL = bottom left
- TR = top right
- BR = bottom right

Artwork

Artwork created with the Business Reply Mail Artwork Online tool contains all the essential elements, in the desired format and bears the appropriate design and physical characteristics of the requested service type. To register for and use the free Business Reply Mail Artwork Online tool, visit canadapost.ca/obc or contact a Canada Post representative.

Illustrated examples

These illustrations are a visual aid to help you produce Business Reply Mail items that meet all the applicable specifications and requirements, while leveraging the areas available for customizing (i.e., Customer-Controlled Area, first line [title], etc.).

Legend for illustrated examples

- ① **1** **Business Reply Mail indicia** – The domestic Business Reply Mail indicia is the “postage stamp”. It contains the customer number and Customer Surtaxing Code. Do not alter. The international Business Reply Mail indicia is the “postage stamp”. It contains the customer number and has bars in both top/left and bottom/right corners. Do not alter.
- ② **2** **Chevrons** – The chevrons shown below the indicia are the Business Reply Mail service identifier. These chevrons are not to be used on any other Canada Post service. Do not alter them.
- ③ **3** **Three extraction bars** – The three vertical bars to the left of the indicia on the domestic Business Reply Mail card or envelope prompt Canada Post’s mail processing to extract items for special handling. Do not alter them. These three vertical bars are not to be used on international Business Reply Mail. Do not alter them.
- ④ **4** **Business Reply Mail barcode and human-readable line** – The barcode and the human-readable line directly above it contain customer identification information. These elements must be placed together on the Business Reply Mail item. Do not alter them.
- ⑤ **5**
- ⑥ **6** **Business Reply Mail address** – This area is for your company name and the Business Reply Mail address. You can request that the address block be provided in a single or bilingual (bilingual side-by-side text) format. Do not alter either the address or postal code provided by Canada Post for Business Reply Mail mailings. You may only modify the first line (title). Depending on the size of the envelope or card, a second line (title) may be available for customizing.

When customizing the first line (title) or second line (title), customers are not permitted to include addressing information.
- ⑦ **7** **Business Reply Mail Postal Code** – The Business Reply Mail Postal Code may differ from your regular postal code. Do not alter the postal code provided for Business Reply Mail mailings. For customers who have a rural address (e.g., postal code with a “0” [zero]) as the second character, the postal code will remain the same.
- ⑧ **8** **Customer-Controlled Area** – The Customer-Controlled Area can be customized by adding your corporate logo or a special message. Fluorescent inks must not be used. International Business Reply Mail items must include the “BY AIRMAIL/PAR AVION” indicator at the top/left corner.
- ⑨ **9** **Quiet zones** – The areas that must be left clear of printing, images and dark colours:
 - Quiet zone on the front: the area 19 mm (0.7 in.) high by 105 mm (4.1 in.) long measured from the bottom right edge.
 - VES barcode area on the back: the area 15 mm (0.6 in.) high by 140 mm (5.5 in.) long measured from the bottom left edge.
- 10** **“REPLY PAID / RÉPONSE PAYÉE” and “CANADA”** – This designation is printed directly above the human-readable line. This designation is required to meet international mailing requirements. Do not alter.

Domestic

Machineable Standard

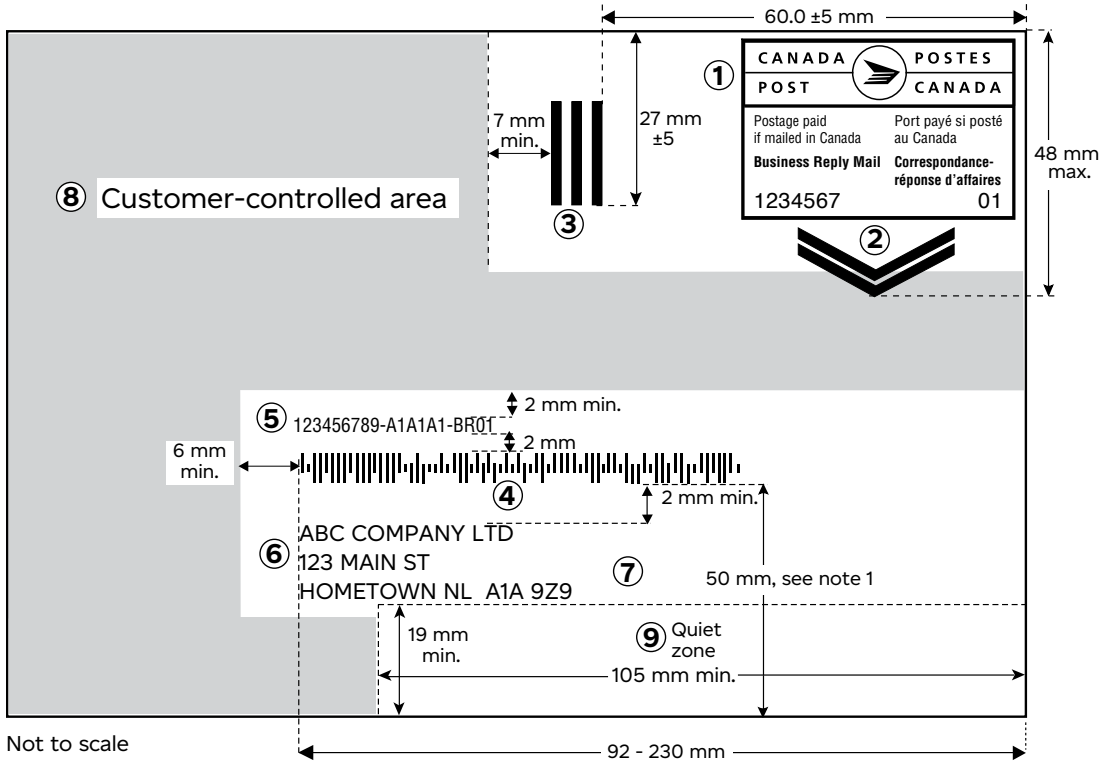

Maximum: 35 mm (1.4 in.) down from the top edge; Minimum: 40 mm (1.6 in.) from the bottom edge.
 Maximum: left edge of barcode or address block, up to 15 mm (0.6 in.) from the left edge of the mail item;
 Minimum: right edge of barcode or address block, up to 15 mm (0.6 in.) from the right edge of the mail item.

Machineable Oversize

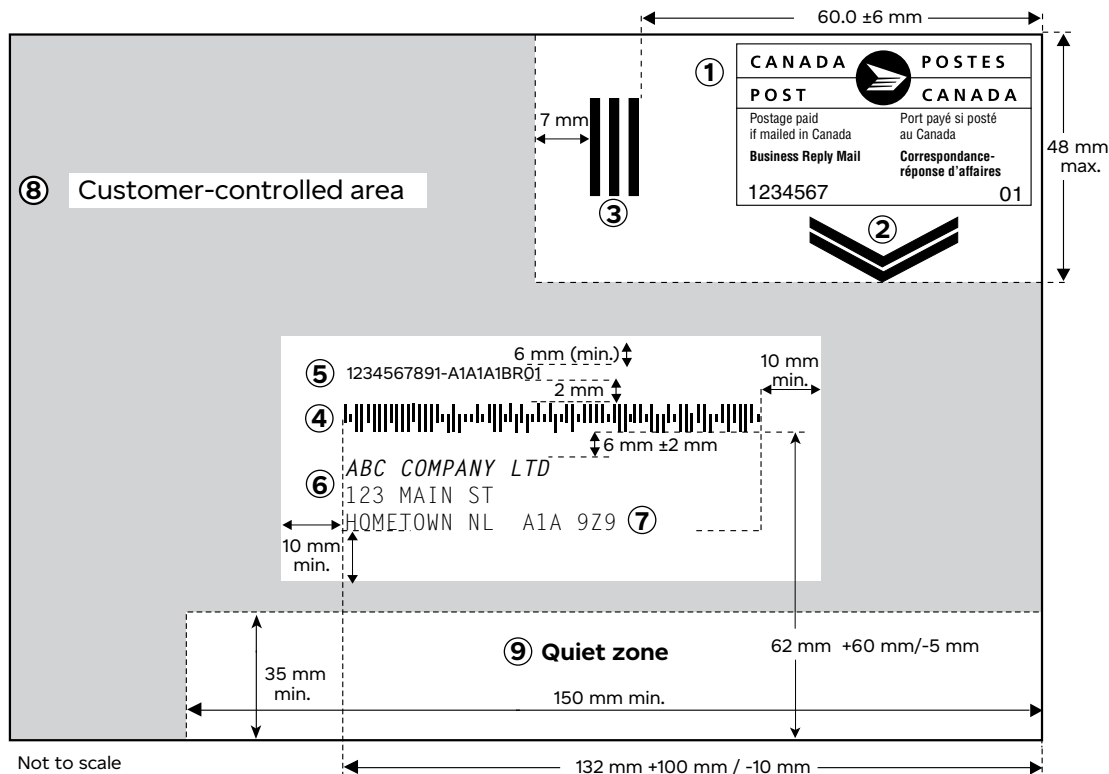

International

Machineable Standard

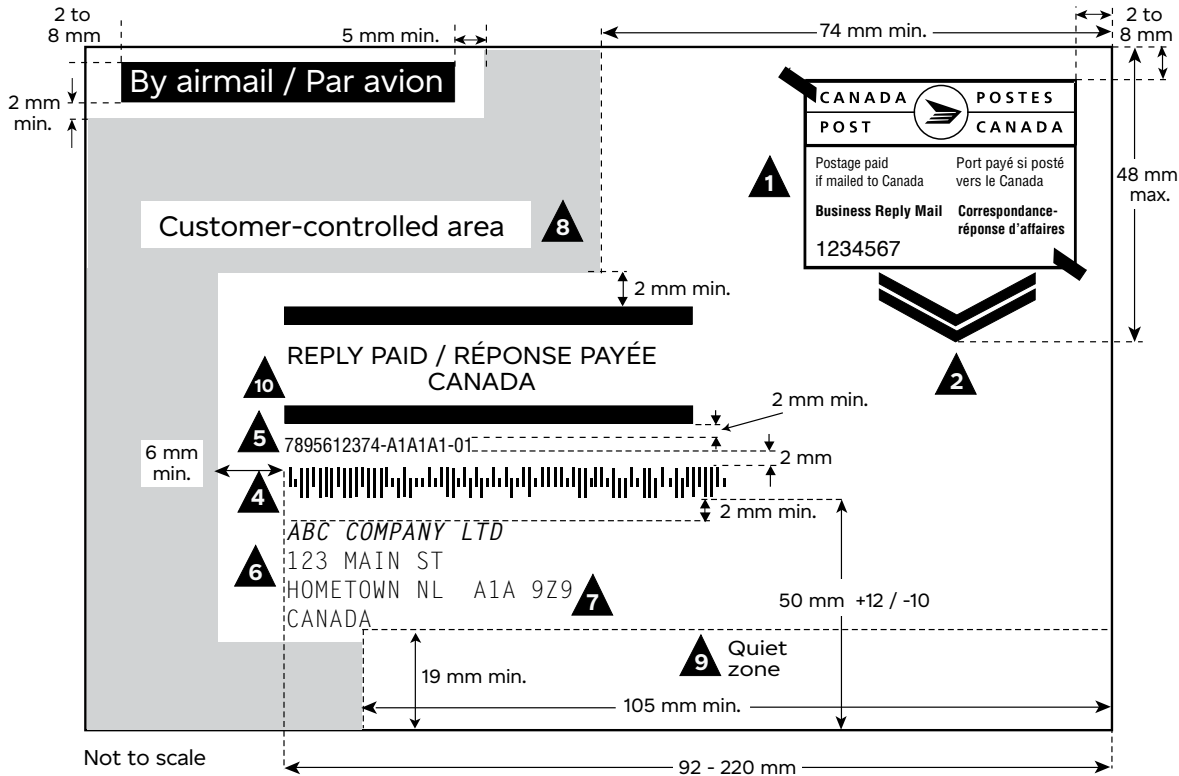

Domestic and International

Location of the VES barcode

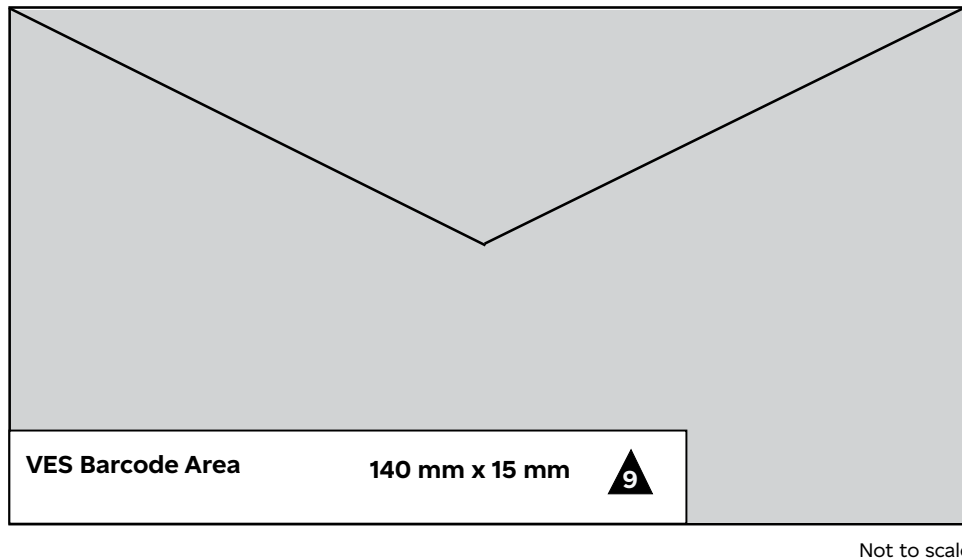

Canada Post will print a fluorescent barcode on the back of machineable domestic and international mail items. This area for this barcode is defined as 140 mm (5.5 in.) long by 15 mm (0.6 in.) high, measured from the bottom left-hand corner. This area must be left clear of printing, images and dark colours.

Designing Machineable Mail – Standard International Incentive Letter-Post

Mandatory requirements

Category	Size	Length	Width	Thickness	Aspect ratio (L/W)	Weight
Standard	Min.	140 mm (5.6 in.)	90 mm (3.6 in.)	0.18 mm (0.007 in.)	1.3:1	3 g* (0.11 oz.)
	Max.	245 mm (9.6 in.)	156 mm (6.1 in.)	5 mm (0.2 in.)	2.6:1	50 g (1.76 oz.)
Postcards	Min.	140 mm (5.6 in.)	90 mm (3.6 in.)	0.18 mm (0.007 in.)	1.3:1	3 g* (0.11 oz.)
	Max.	235 mm (9.2 in.)	120 mm (4.7 in.)	5 mm (0.2 in.)	2.6:1	50 g (1.76 oz.)

* Recommended by Canada Post.

Machineability

Shape

Rectangular.

Material

- Must be paper; items cannot be made or wrapped in plastic.
- Minimum paper weight for:
 - envelope: 75 gsm (approx. 20 lb. bond);
 - folded self-mailer: 90 gsm (approx. 60 lb. text);
 - cards and postcard: 160 gsm (approx. 60 lb. cover).
- Must be sufficiently flexible to bend; items cannot be rigid.
- Transparent plastic envelopes (also referred to as polybags) are acceptable for movement. The polybag must be completely sealed for the movement of Premium and Per Item items.

Enclosures

- Any paper enclosure is acceptable.
- For **Premium**, **Per Item** and **Standard**, no attachments are acceptable except those that are necessary for the purpose of addressing, payment of postage, service endorsements and customs requirements.

Sealing

Envelopes

Must be closed and sealed with adhesive, with no more than 35 mm (1.4 in.) of the flap unsealed on each end. To prevent envelopes from sticking together, do not apply an excessive amount of adhesive. Envelopes must not be sealed with staples, clasps or other similar devices.

Standard items

Must be securely closed (e.g., tabbed, spot sealed or in a wrapper), but easy to open and close again to allow inspection.

Premium and Per Item Self-mailers

Must be sealed or glued on all four sides.

Readability

Destination address

Address zone

Whether vertically or horizontally oriented, the complete address must appear inside the following area:

- 35 mm (1.4 in.) from the top;
- 10 mm (0.4 in.) from the bottom, left and right edges.

Address labels and windows must be within the address zone.

Quiet zone

- Around the address block, leave at least 5 mm (0.2 in.) clear of printing and dark colours.
- For window envelopes, ensure that the entire address remains fully visible through the window, even if the enclosure shifts within the envelope.

Postage zone

- The top-right area is reserved for postage, measuring a width of 74 mm (2.9 in.) and a height of 35 mm (1.4 in.).
- The indicia must be placed on the same side as the destination address (the front).
- If the indicia is placed outside the postage zone it must be located above and to the right of the address.

Return address zone

- The preferred location is on the front of the item above the address zone (35 mm [1.4 in.] from the top).
- Must be the same orientation as the destination address.
- A minimum vertical separation of 15 mm (0.6 in.) is required between the bottom of the return address and the top of the destination address.

Fonts

Commercially available fonts should be easy to read, have well-defined characters and:

- Not overlap to the line above or below
- Not contain text effects (i.e., shadow, emboss, etc.)
- Not contain random heights within characters
- Not include calligraphy styles (i.e., *The quick brown fox jumps over the lazy dog*).

Fonts must be a dark colour (preferably black). There should be good contrast between address and background.

Failure to meet these mandatory requirements may result in mail delays or surcharges. Not all creative designs and sealing options are mentioned above, assessment of your physical mail item is recommended.

Designing Machineable Mail – Oversize International Incentive Letter-Post

Mandatory requirements

Category	Size	Length	Width	Thickness	Weight
Oversize	Min.	140 mm (5.6 in.)	90 mm (3.6 in.)	0.18 mm (0.007 in.)	3 g* (0.11 oz.)
	Max.	380 mm (14.9 in.)	270 mm (10.6 in.)	20 mm (0.8 in.)	500 g (17.6 oz.)

* Recommended by Canada Post.

Machineability

Shape

Must be rectangular.

Material

- Envelopes must be produced from paper – minimum paper weight 90 gsm (approx. 24 lb.).
- Windows must be covered with transparent material (max haze of 75%, 159 gloss unit or less).
- Plastics and similar transparent wrappings are acceptable – must be at least 0.03 mm thick.
- Items can be packaged in flexible or rigid material.
- Transparent plastic envelopes (also referred to as polybags) are acceptable for movement. The polybag must be completely sealed for the movement of Premium and Per Item items.

Enclosures

- Must be uniform in thickness.
- Must closely fit the size of the envelope (no more than 15 mm [0.6 in.] smaller than the envelope).
- For **Premium**, **Per Item** and **Standard**, no attachments are acceptable except those that are necessary for the purpose of addressing, payment of postage, service endorsements and customs requirements.

Sealing

Envelopes must be closed and sealed with adhesive, with no more than 35 mm (1.4 in.) of the flap unsealed on each end. To prevent envelopes from sticking together, do not apply an excessive amount of adhesive. Envelopes must not be sealed with staples, clasps or other similar devices.

Readability

Destination address

Address zone

Whether vertically or horizontally oriented, the complete address must appear inside the following area:

- three-quarter (horizontal address orientation) / four-fifth (vertical address orientation) of the total width from the bottom
- 10 mm (0.4 in.) from the bottom, left and right edges address labels and windows must be within the address zone.

Quiet zone

- Clear of printing and dark colours, above the top line of the address block, leave at least 6 mm (0.2 in.); 10 mm (0.4 in.) to the left, right and below of the address block.
- For window envelopes, ensure that the entire address remains fully visible through the window, even if the enclosure shifts within the envelope.

Note: Every item must be addressed to a specific individual or company and include the complete mailing address, with the country of destination which must be spelled in full and printed alone on the last line, in capital letters, in English or French.

Postage zone

- The top-right area is reserved for postage, measuring a width of 74 mm (2.9 in.) and a height of 35 mm (1.4 in.).
- The indicia must be placed on the same side as the destination address (the front).
- If the indicia is placed outside the postage zone it must be located above and to the right of the address.

Return address zone

- The preferred location is on the front of the item above the address zone (one-quarter [horizontal] / one-fifth [vertical] from the top).
- Must be the same orientation as the destination address.
- A minimum vertical separation of 18 mm (0.7 in.) is required between the bottom of the return address and the top of the destination address.

Note: There must be only one return address on the outside of each item, and it must be Canadian.

Fonts

Commercially available fonts should be easy to read, have well-defined characters and:

- Not overlap to the line above or below
- Not contain text effects (i.e., shadow, emboss, etc.)
- Not contain random heights within characters
- Not include calligraphy styles (i.e., *The quick brown fox jumps over the lazy dog*).

Fonts must be a dark colour (preferably black). There should be good contrast between address and background.



Commercial Mail Preparing requirements

Ensure your mailing can be processed
and delivered efficiently



Commercial Mail

Preparing requirements

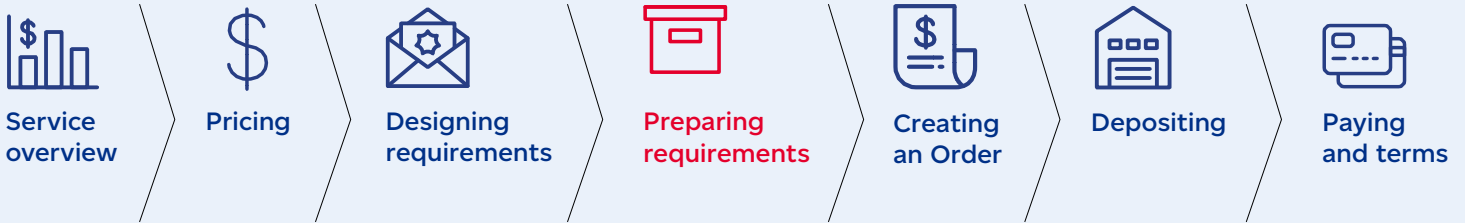

There are two ways to process your mail items:

1. Through our machines – Machineable Mail
2. Not processed through our machines – Special Handling and Delivery Facility Presort (Publications Mail only).

Are you preparing...

Description	ILM	PUBS	BRM	IILP
Machineable Mail Requires mailers to face and containerize the mail items, label containers and label shipping units.	yes	yes	N/A	yes
Special Handling Allows mailers to sort their mail items for specific letter carrier walks (or other delivery routes) using presortation software recognized by Canada Post.	N/A	yes	N/A	N/A
Delivery Facility Presort Allows mailers to sort their mail items manually according to the National Presortation Schematic (NPS).	N/A	yes	N/A	N/A



Container and shipping unit types

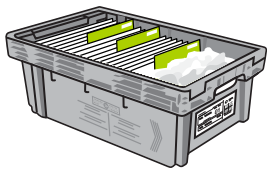

Letterflatainer



Flats tubs



Customer-supplied containers

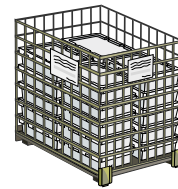

Monotainer



Pallet

Container dimensions are the measurements inside the container. Imperial equivalents are provided for your convenience.

Canada Post-supplied containers	Length	Width	Height	Container weight (without lid)	Maximum weight (including mail, container and lid)
Letterflatainer (LFT)* for Standard items	394 mm (15.6 in.)	244 mm (9.6 in.)	156 mm (6.1 in.) with lid	0.995 kg (2.2 lb.)	22.7 kg (50 lb.)
Flats tubs for Oversize items**	405 mm (15.9 in.)	240 mm (9.4 in.)	303 mm (11.9 in.)	1.7 kg (3.7 lb.)	22.7 kg (50 lb.)

* LFTs are designed to work without lids

** Flats tubs should be deposited with lids. If lids are not available, we recommend cardboard separators be used between each level to protect your mail items.

Customer-supplied containers	Length	Width	Height	Container weight (without lid)	Maximum weight (including mail, container and lid)
For Standard and Oversize items	535 mm (21.06 in.)	251 mm (9.8 in.)	303 mm (11.9 in.)	–	22.7 kg (50 lb.)

Customer-supplied cardboard containers must meet the requirements, be completely sealed and be sturdy to withstand handling during processing.

Shipping unit type

Shipping unit	Weight	Length	Width	Height	Maximum weight (including mail and shipping unit)
Monotainer	97 kg (213.8 lb.)	1.322 m (52 in.)	1.067 m (42 in.)	1.115 m (43.8 in.)	900 kg (1,984.2 lb.)
Pallet (plastic and wood) (minimum ordering quantity is 40 units.)	9 kg (19.8 lb.)	1.22 m (48 in.)	1.02 m (40 in.)	1.5 m (59 in.)	900 kg (1,984.2 lb.)

For information on how to construct your pallet, see [Appendix B: Pallet Construction Specifications](#).

Ordering equipment

You may enquire about or order our equipment (containers and shipping units) by contacting the National Empty Container Facility (NECF) order desk by phone at 905-565-0480, by fax at 905-564-6830, by email at necfteo@canadapost.ca or through a Regional Equipment Coordinator.

The supply of our equipment depends on conditions and availability. When our equipment is not available, Canada Post pre-approved customer-supplied containers (e.g., cardboard boxes) and/or pallets must be used.

List of Regional Equipment Coordinators

Region	Contact information
Atlantic	Nova Scotia/Prince Edward Island Halifax tel.: 902-494-4001 ext. 4707
	New Brunswick Moncton tel.: 506-381-5347 Saint John tel.: 506-653-5270
	National Empty Container Facility (NECF) Tel.: 905-565-0480 Fax: 905-564-6830 Email: necfteo@canadapost.ca
Greater Toronto Area	Ottawa Tel.: 613-734-1431 Email: equipmentline.ompp@canadapost.ca
	Hamilton National Empty Container Facility (NECF) Tel.: 905-565-0480 Fax: 905-564-6830 Email: necfteo@canadapost.ca
Huron Rideau	London Tel.: 519-473-6738

Region	Contact information
Pacific	Vancouver Tel.: 604-276-5538
Prairies	Winnipeg Tel.: 204-987-5100, ext. 2019
	Edmonton Tel.: 780-945-2600, ext. 53292 Fax: 780-945-2608
	Calgary Tel.: 403-974-2000, ext. 2170
Quebec	Montréal Tel.: 514-345-7369 Email: uvcr.mtl@canadapost.ca

Our equipment may be used only when you use Canada Post products or services. It remains our exclusive property. Personal use is not permitted. You are responsible for ensuring that the equipment remains in good condition; reasonable wear-and-tear is acceptable.



Preparing Machineable Mail

Requirements

Placing mail items in acceptable containers

- In order to help facilitate mail processing, customers should not fill containers to full capacity. Space should be left for an operator to insert both hands in the container to remove the mail.
- Only the last container may be less than full. To maintain the integrity of the mail, we recommend using packing material to protect mail items from shifting.
- Ensure the items do not stick together as they may be damaged during processing or jam and/or damage the equipment.

Letterflatainers (LFTs)

For **horizontal** address orientation, the postal indicia must appear in the upper right-hand corner.

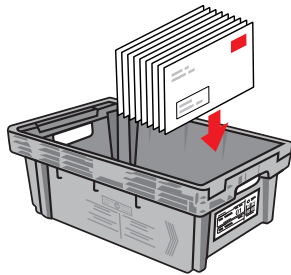

For **vertical** address orientation, the postal indicia must appear in the upper left-hand corner.

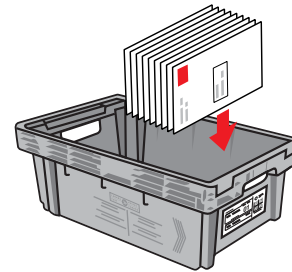

Flats tub

For items too wide to fit, place the mail **standing horizontally**.

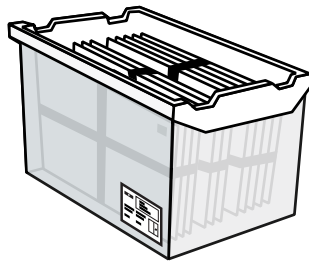

Mail can be placed within the container **laying flat**.

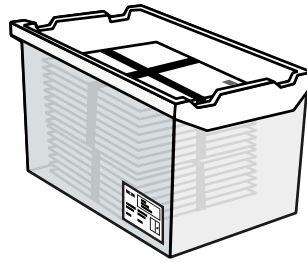

Mail can be placed **standing vertically** facing the narrow side of the flats tub.

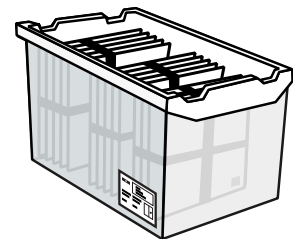

Labelling containers

All containers must be labelled and be bilingual. Labelling individual containers is not required only if all containers are placed in monotainers or on pallets. For label specifications, visit canadapost.ca/labels.

Note: Large-volume mailers may choose between producing labels individually or in continuous strips (1 up, 2 up, etc.) as best suited to the intended overprinting process.

Routing information

- Service name
- Service size/item

Example of container label

If you are using Canada Post-supplied containers, insert your container label into the label holder prior to depositing your mailing.

If you are using customer-supplied cardboard containers, affix a container label on the side of each container. You can order self adhesive labels online at canadapost.ca/obc under form number 33-086-732 or by telephone at 1-888-550-6333.

We recommend that the Order (Statement of Mailing) number be written on the label. For customers wishing to include other internal directives on the shipping containers, a label colour different than white is recommended.

Examples of labels

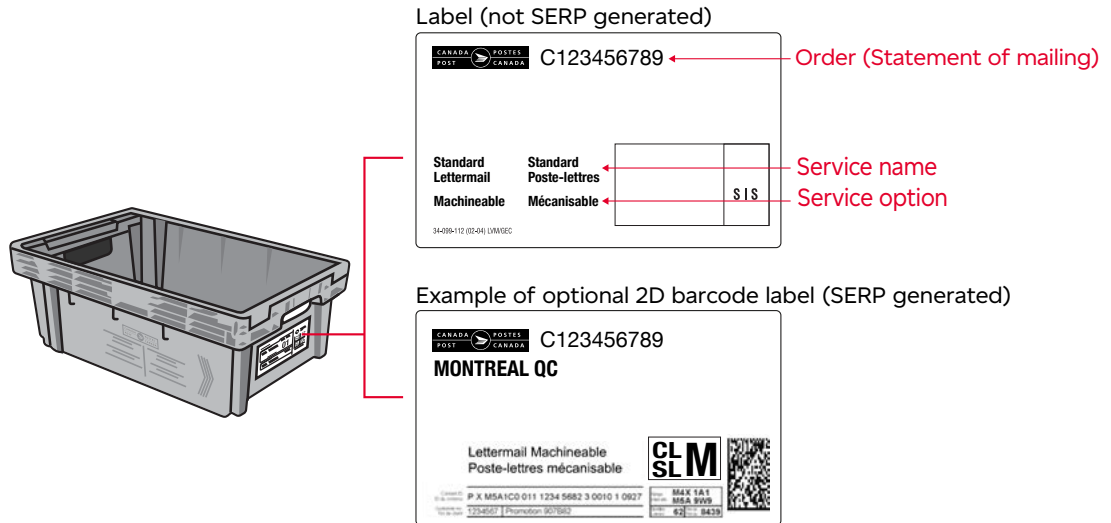

Placing containers in shipping units

Shipping units (monotainers and pallets – also referred to as skids) are used to group containers intended for one Order or bound for the same destination (e.g., all mail items for Vancouver arrive on one pallet). This reduces the handling and helps ensure timely delivery.

Shipping Unit	Minimum	Maximum
Pallet	<ul style="list-style-type: none"> No minimum requirement 	<ul style="list-style-type: none"> 48 LFTs, or 32 flats tubs, or 1.5 m (including pallet height)
Monotainer	<ul style="list-style-type: none"> No minimum requirement 	<ul style="list-style-type: none"> 48 LFTs (40 LFTs with lids) 24 flats tubs or contents may be piled up to 25 mm (1 in.) below the top of the monotainer

Securing pallets

All pallets must be securely fastened and structurally sound to safely handle and transport.

If using plastic pallets, it is recommended to apply four cross straps encompassing both the pallet bottom and the containers. Metal strapping is not permitted.



Stacking pallets or monotainers

Note: Not all locations are equipped to process mail received in monotainers or pallets that are double-stacked. See the Find a Deposit Location tool at canadapost.ca/DepositLocations to ensure the deposit location is properly equipped to handle your mail.

Multiple pallets going to the same destination, as per the National Presortation Schematic (NPS), may be stacked on top of each other as long as they are secured together with straps. Stacking during storage and transportation uses warehouse space more efficiently. For example, where there are two pallets – one going to Vanier Station and one going to Merivale depot – these two pallets may be strapped together and identified to Ottawa (City Consolidation).

Pallets

Two pallets strapped together must not exceed 1.5 m (4.9 ft.) in height or 900 kg (1 ton) in weight.

Monotainers

Two monotainers stacked together must not exceed 1,800 kg (2 tons); each monotainer must not exceed 900 kg (1 ton).

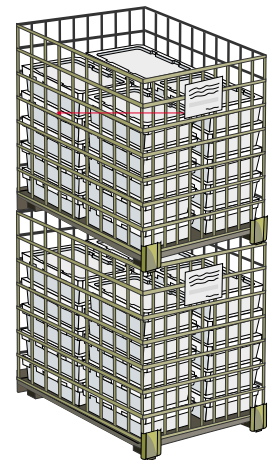
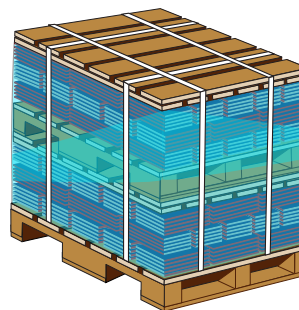

Labelling shipping units

Label specifications

All pallets and monotainers must be labelled. This will ensure that your mail is directed to the appropriate facility within Canada Post's network. For customers using SERP software to prepare their Machineable Mail, a 2D barcoded shipping unit label is available and optional.

Labels must be white and meet the following requirements:

- measure 279 mm x 216 mm (11 in. x 8.5 in.) in letter landscape or letter portrait format. Labels may also be prepared in legal portrait format 216 mm x 355 mm (8.5 in. x 14 in.),
- be printed in black in a font size large enough to occupy the entire label,
- prominently display the facility name (which must be visibly larger than all other information),
- be visible on two sides on the pallet or monotainer.

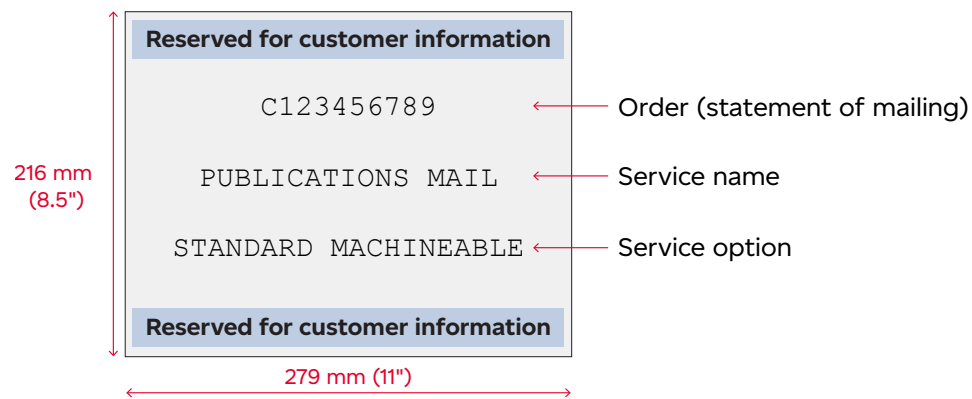

Routing information

- Service name
- Service option

We recommend that the Order number be written on the label. For customers wishing to include other internal directives on the shipping containers, a label colour different than white is recommended.

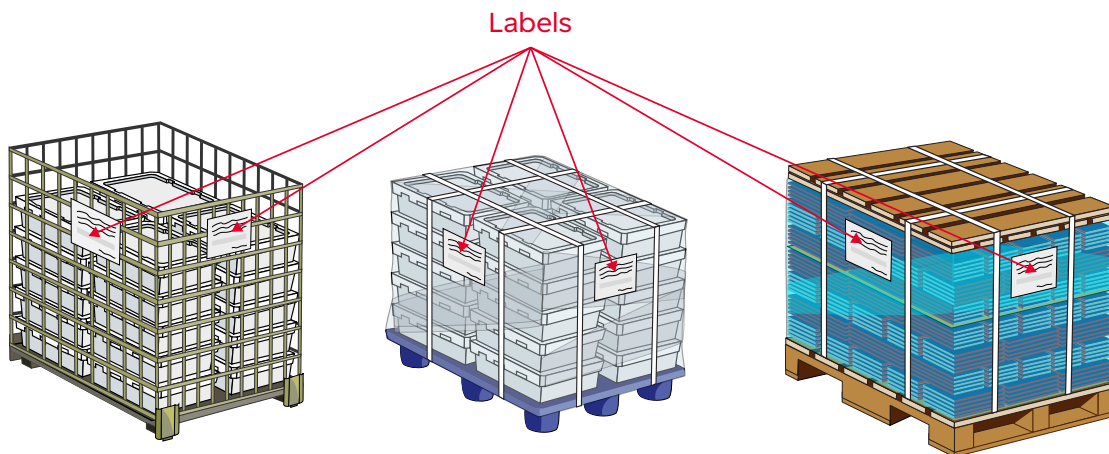

Preparing Publications Mail Special Handling

Special Handling is available for customers who want to be creative or for customers who would prefer that their mail items not be processed on our machines.

Ensure you are using a presortation software recognized by Canada Post. The software does the following:

- sort mail items by their postal code, and according to the delivery route identified by the Delivery Mode Code (DMC)
- groups mail items by a common destination according to the National Presortation Schematic (NPS).

Special Handling elements

Software Evaluation and Recognition Program (SERP)

Our Software Evaluation and Recognition Program (SERP) exists to evaluate the accuracy of presortation software programs.

For more information or to find a list of our approved software vendors, visit canadapost.ca/presortationsoftware.

Postal code

The postal code is a six-character alphanumeric code in the form of ANA NAN, in which “A” represents a letter of the alphabet, and “N” represents a number. It is an integral part of every postal address in Canada, and was designed to help sort mail, both mechanically and manually.

Rural areas are identified by a zero in the FSA (e.g., MOL 3K2).

For more detailed information, visit [Section 5](#) of Addressing guidelines in the *Canada Postal Guide*.

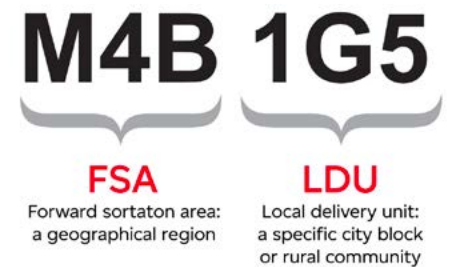

Delivery Mode Code (DMC)

The Delivery Mode Code is an identifier of a specific delivery route (also known as mode) for an individual address.

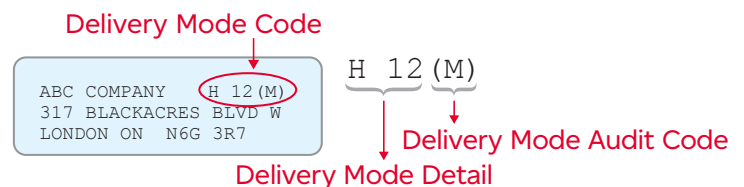

The DMC consists of two parts, a Delivery Mode Audit Code (DMAC) and a Delivery Mode Detail (DMD).

The **Delivery Mode Detail (DMD)** identifies the letter carrier route or delivery mode as well as the letter carrier responsible for delivery.

The **Delivery Mode Audit Code (DMAC)** identifies which version of the National Presortation Schematic (NPS) and Delivery Mode Data Product (DMAC) was used to prepare a mailing.

The DMC must be printed and placed in the address block of every item.

Delivery Mode Code Placement. The DMC may appear on any non-address line in or above the address block, that is, on any line that does not contain delivery information. When placed on the same line as street addresses, city or province names, or postal codes, a 10 mm (0.4 in.) space between the delivery address information line and the DMC must be maintained.

DMC placement on addresses

With three or more lines

3 to 4 blank spaces to the right of the non-address line.

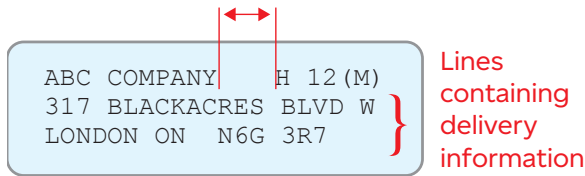

With four or more lines

3 to 4 blank spaces to the right of the longest non-address line

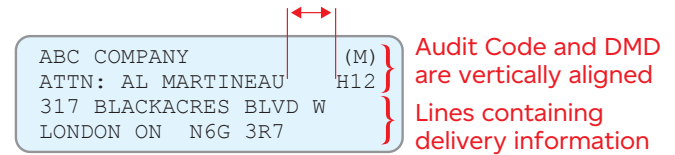

Above the address block

Up to 2 lines above the address block, 3 to 4 blank spaces to the right of the non-address line

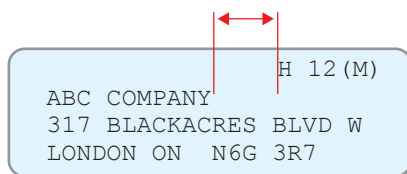

On the same line

A 10 mm (0.4 in.) space between the delivery address information line and the DMC must be maintained

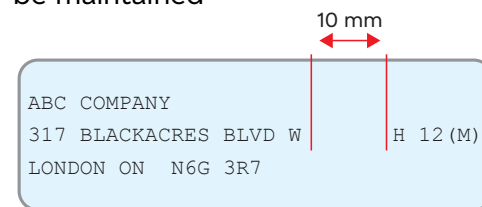

National Presortation Schematic (NPS)

The National Presortation Schematic (NPS) indicates how mail is distributed through specific Canada Post facilities. It lists all Forward Sortation Areas (FSAs) and shows how to consolidate mail into groupings and containers. The four NPS levels of consolidation are:

Level	Level 1 – DF	Level 2 – City	Level 3 – DCF	Level 4 – FCP
Consolidation	Delivery Facility	City	Distribution Centre Facility	Forward Consolidation Point

Any mail items that cannot be consolidated into one of these four levels will be consolidated as Residue.

Canada Post updates the NPS monthly to reflect the changes in Canada's addresses. These monthly updates also appear in presortation software recognized by Canada Post. To avoid delays and extra handling charges, you must use the current version of both the Delivery Mode Data and the recognized presortation software. For detailed information, visit canadapost.ca/nps.

Grouping and identifying mail items

All items in a mailing must be part of a grouping. All groupings (except Residue) must have a minimum of six items. If this minimum requirement is not met, the items are consolidated to the next level.

Once your mail has been presorted, make sure it can withstand handling. Preserve the integrity of your groupings by separating them in their containers, using one of the following acceptable methods: Bundling, Separator Cards and Edgemarking.

Levels of groupings

Type of groupings	Presortation software groups mail items that have a common destination and/or sortation
Delivery Mode Direct (DMD)	Group all items delivered by the same letter carrier.
NPS Level 1 – Delivery Facility (DF)	Group all items delivered from the same postal station or letter carrier depot.
NPS Level 3 – Distribution Centre Facility (DCF)	Group all items delivered in the same area, such as a city and surrounding area.
NPS Level 4 – Forward Consolidation Point (FCP)	Group all items delivered in the same province.
Residue	Place all remaining items into a Residue grouping.

Separating and identifying groupings

Bundling

A bundle is a group of mail items identified and secured together by strapping (e.g., elastic bands, string, or plastic straps) or by shrink-wrapping. Shrink-wrapping is an acceptable method of bundling for Oversize items only. When a bundle exceeds the maximum thickness, it is preferable to make two evenly divided bundles.

The maximum thickness takes precedence over the minimum number of items. The last Residue bundle has no minimum number of items, although it still must not exceed the maximum thickness per bundle.

Type of mailing	Maximum bundle thickness	Minimum number of items per bundle
Standard	100 mm (4 in.)	6 items
Oversize	200 mm (8 in.)	6 items

Identifying bundling options

Option 1 – Bundling labels

When using bundling as a separation method, DCF, FCP and Residue bundles must be identified with a bundle label (also called a facing slip). DMD and DF bundles do not require labels.

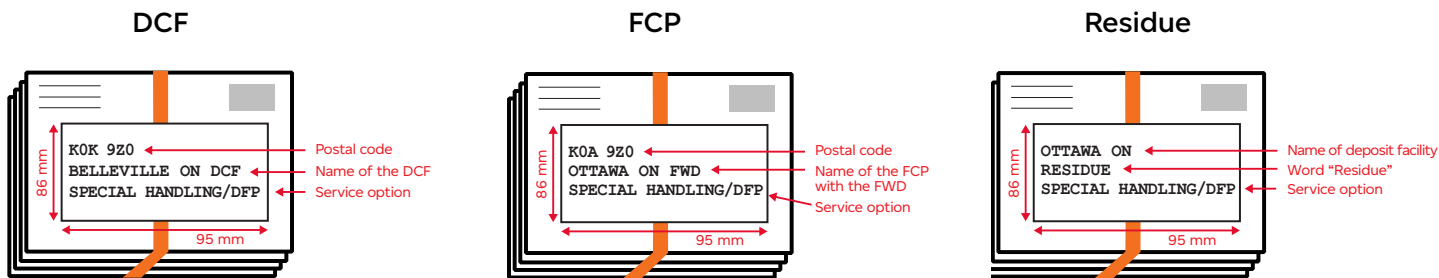

Category	DCF	FCP	Residue
Routing information on bundle labels	<ul style="list-style-type: none"> Postal code of the DCF, as per the NPS (e.g., KOK 9Z0) Name of the DCF (e.g., BELLEVILLE ON DCF) Service size/item 	<ul style="list-style-type: none"> Postal code of the FCP, as per the NPS (e.g., KOA 9Z0) Name of the FCP with the forward abbreviation FWD (e.g., OTTAWA ON FWD) Service size/item 	<ul style="list-style-type: none"> Name of the deposit facility (e.g., OTTAWA ON) The word "RESIDUE" Service size/item

Additional information may appear above or below the routing information as long as the routing information is more prominent.

Option 2 – Optional endorsement line (OEL)

OELs can be generated by the presortation software and printed directly onto the first mail item in each bundle. OELs must meet the following requirements:

- consolidation information is printed on the top line of the address block or label
- font type and size are identical to that of the address (an UPPERCASE font is recommended), and
- is visible if positioned within a window.

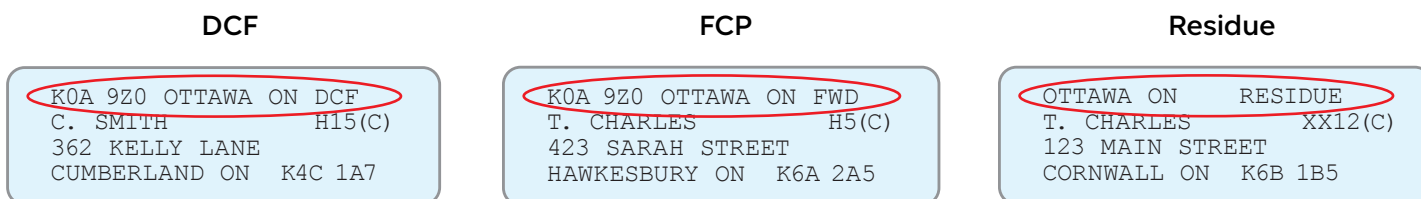

Securing bundles

The **strapping material** must be strong and tight enough to hold the bundle together, without the contents sliding, when held vertically.

Size/item	Strapping requirement
Standard items Oversize items (only for bundles placed in Level 1 [DF] containers)	Single strapping <ul style="list-style-type: none"> • Plastic or paper strapping material • Elastic bands when placed in hard-sided containers or customer-supplied boxes • It is recommended, but not mandatory, to apply the strapping to the shorter dimension of the bundle.
Oversize (except for bundles placed in Level 1 [DF] containers)	Double strapping <ul style="list-style-type: none"> • Strings or manually applied plastic straps.

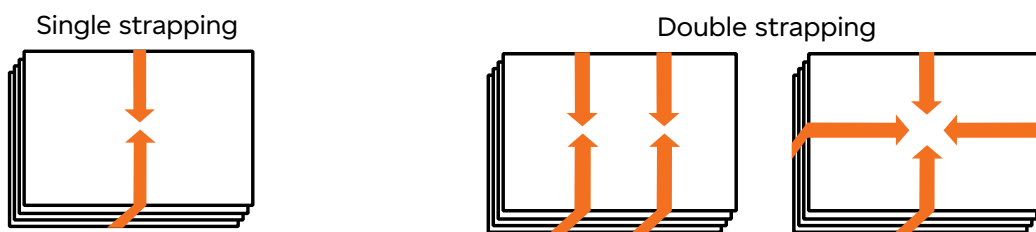

If your mail items are bound using spines, to create an even bundle, you may place the bottom half and top half of the bundle with their spines facing in opposite directions.

Note: Shrink-wrapping is an acceptable method of bundling for Oversize items.

The plastic used for shrink-wrapping must be strong enough to ensure the bundles remain secured during handling.

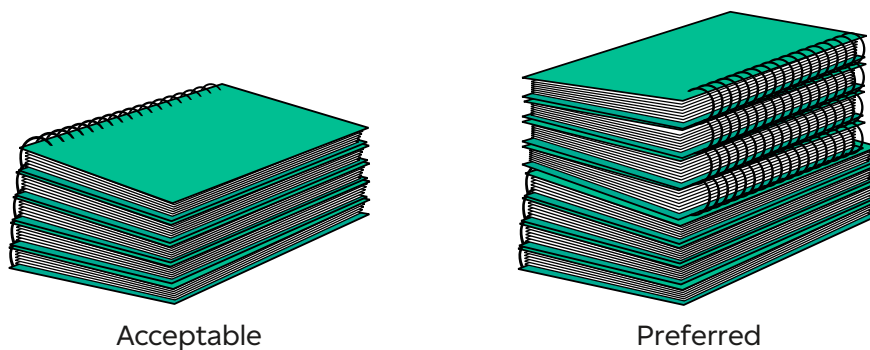

Separator cards

- be made of thin, rigid cardboard of any colour (a weight of 120 to 160 grams [4.2 oz. to 5.6 oz.] per square metre)
- extend at least 20 mm (0.8 in.) above the mail items
- be at least 155 mm (6.1 in.) wide
- be placed in front of the first mail item in each grouping. If a grouping is too large to fit into one container, a second separator card is required at the front of the second container.

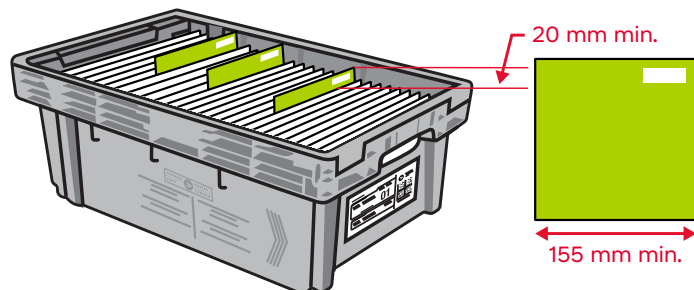

When using separator cards as a separation method, you must identify each DCF, FCP and Residue grouping on the part of the separator card visible above the mail items. The following information must be provided.

Category	For DCF groupings	For FCP groupings	For Residue groupings
Required information	<ul style="list-style-type: none"> • Postal code of the DCF, as per the NPS (e.g., K0K 9Z0) • Name of the DCF (e.g., BELLEVILLE ON DCF), and • The service size/item 	<ul style="list-style-type: none"> • Postal code of the FCP, as per the NPS (e.g., KOA 9Z0) • Name of the FCP with the forward abbreviation FWD (e.g., OTTAWA ON FWD) • The service size/item 	<ul style="list-style-type: none"> • Name of the deposit facility (e.g., OTTAWA ON) • The word “RESIDUE” • The service size/item

Edgemarking

The following requirements must be met:

- their colour significantly contrasts with that of the mail item
- the same colour is used for edgemarking the entire mailing
- the edgemarking begins approximately 40 mm (1.6 in.) from the upper-right edge of the mail item.

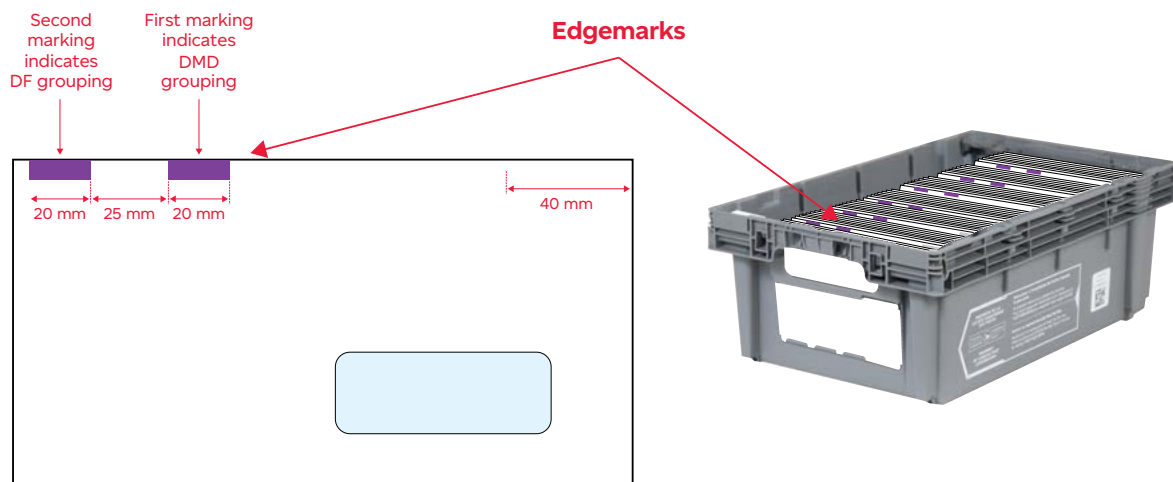

The edgemarks should be approximately 20 mm (0.8 in.) long, separated by a gap of approximately 25 mm (1 in.):

- the marking nearest the upper-right edge indicates a Delivery Mode Direct (DMD) grouping
- the additional markings indicate Delivery Facility (DF), Distribution Centre Facility (DCF) and Forward Consolidation Point (FCP) groupings.

It is acceptable for DCF and FCP groupings to have only two marks, but the marks must be in the DMD and DF locations.

Filling containers

To help mitigate operator injuries when our employees are processing your mail, we are requesting that you do not overfill containers. We recommend 50 mm (2 in.) of space be left in a container to allow an operator to remove the mail. A simple way to this is to tilt the Letterflattainer (LFT) on an angle so that the envelopes gravitate downward, when about 50 mm (2 in.) remain, the container is at capacity. This practice also helps to protect your mail items from damage.

Minimum requirements for filling containers

Consolidation level	If only one container to a destination	If multiple containers to a destination	
	Fill to capacity of:	All containers except the last, fill to capacity of:	Last container, fill to capacity of:
Level 1 – DF	50%	95%	No minimum
Level 2 – City	70%	95%	No minimum
Level 3 – DCF	70%	95%	No minimum
Level 4 – FCP	50%	95%	No minimum
Residue	No minimum	95%	No minimum

Preserving integrity of mail preparation

For any container with less than 95% of capacity, when using:

- **separator cards or edgemarking** as a separation method, you must use packing
- **bundle with strapping** as a separation method, we recommend adding packing

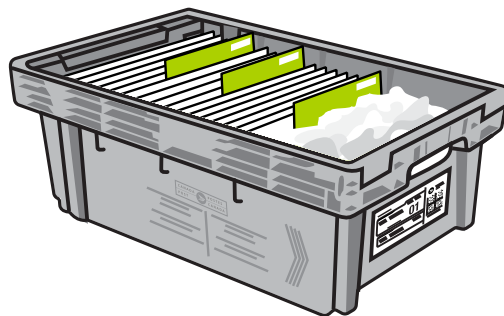

Labelling containers

All containers must be labelled with their destination details using routing information from the National Presortation Schematic (NPS). Correctly labelling your containers will ensure your mail is directed to the appropriate work centre within a Canada Post facility.

Note: The use of 2D barcoded container labels for Special Handling mailings is mandatory. The presortation software will provide the information you need to print on container labels. These labels must be bilingual.

Labels for Residue monotainers or pallets and all labels generated without the use of SERP software must display the name of the deposit facility and the word “Residue”.

Note: In order to avoid delays or extra handling charges, it is extremely important to follow the SERP mailing plan instructions.



Placing containers in shipping units

Shipping units (monotainers and pallets – also referred to as skids) are used to group containers or to Brick-pile mail intended for one Order or bound for the same destination (e.g., all mail items for Vancouver arrive on one pallet). This reduces the handling and helps ensure timely delivery.

Filling shipping units requirements

Type of shipping unit	Destination	Minimum	Maximum
Pallet	Any (when using containers)	<ul style="list-style-type: none"> • 18 letterflatainers (LFTs), or • 12 flats tubs, or • 500 mm (19.7 in.) (excluding height of pallet) 	<ul style="list-style-type: none"> • 48 letterflatainers (LFTs) (40 letterflatainers with lids), or • 32 flats tubs, or • 1.5 m (4.9 ft.) (including height of pallet)
Monotainer	Mail destined within the province of deposit	<ul style="list-style-type: none"> • 18 letterflatainers (LFTs), or • 12 flats tubs 	<ul style="list-style-type: none"> • 48 letterflatainers (LFTs) (40 letterflatainers with lids), or • 24 flats tubs or contents may be piled up to 25 mm (1 in.) below the top of the monotainer
	Mail destined outside the province of deposit	<ul style="list-style-type: none"> • 27 letterflatainers (LFTs), or • 18 flats tubs 	<ul style="list-style-type: none"> • 48 letterflatainers (LFTs) (40 letterflatainers with lids), or • 24 flats tubs or contents may be piled up to 25 mm (1 in.) below the top of the monotainer

Note: Detailed information on Brick-piling mail items can be found in [“Appendix A: Brick-piled Mail Items”](#).

Labelling shipping units

All pallets and monotainers must be labelled. SERP generated labels contain a 2D barcode. This will ensure that your mail is directed to the appropriate facility within Canada Post's network. **We recommend that the Order number be written on the label.**



Routing information

- the service name
- the service size/item

Two sides of the pallet or monotainer must be labelled

For customers wishing to include other internal directives on the shipping containers, a label colour other than white is recommended.

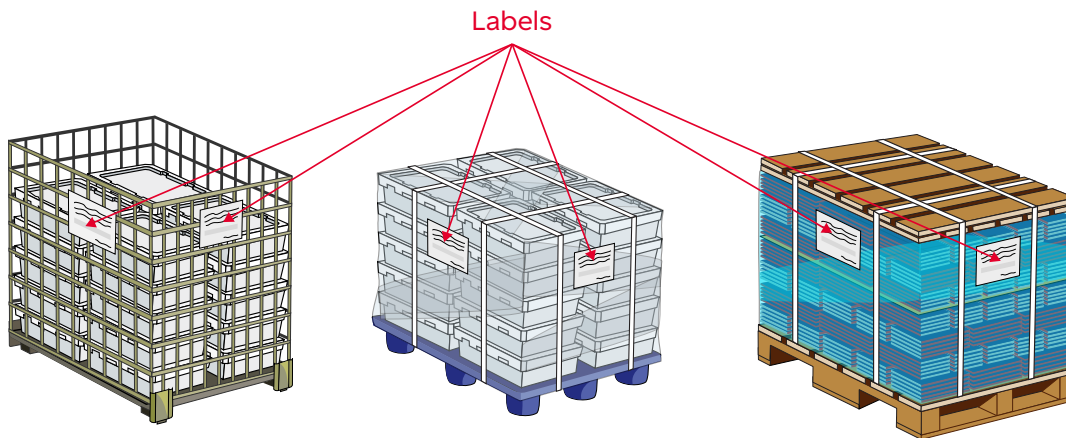

Securing pallets

All pallets must be securely fastened and structurally sound to safely handle and transport.

If using plastic pallets, it is recommended to apply four cross straps encompassing both the pallet bottom and the containers. Metal strapping is not permitted.



Stacking pallets or monotainers

Multiple pallets going to the same destination, as per the National Presortation Schematic (NPS), may be stacked on top of each other as long as they are secured together with straps. Stacking during storage and transportation uses warehouse space more efficiently. For example, where there are two pallets – one going to Vanier Station and one going to Merivale depot – these two pallets may be strapped together and identified to Ottawa (City Consolidation).

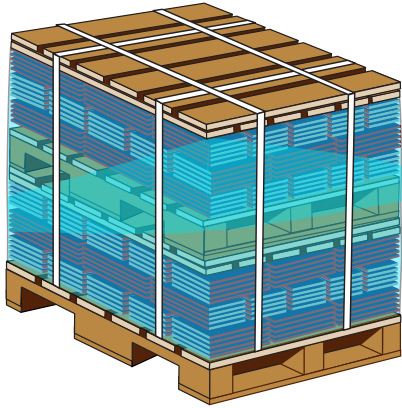

Two pallets strapped together must not exceed 1.5 m (4.9 ft.) in height or 900 kg (1 ton) in weight.

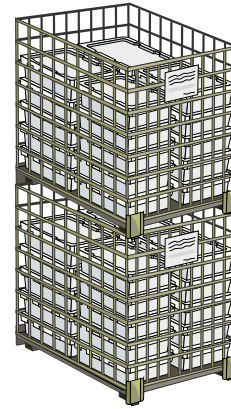

Two monotainers stacked together must not exceed 1,800 kg (2 tons); each monotainer must not exceed 900 kg (1 ton).

Note: Not all locations are equipped to process mail received in monotainers or pallets that are double-stacked. See the Find a Deposit Location tool at canadapost.ca/depositlocations to ensure the deposit location is properly equipped and capable of handling your mail.



Preparing Publications Mail Delivery Facility Presort

Delivery Facility Presort Elements

Delivery Facility Presort mail must be presorted, grouped and containerized.

Manual presortation

Mail items are sorted manually by:

- their postal code, and
- groups mail items by a common destination according to the National Presortation Schematic (NPS).

Postal code

The postal code is a six-character alphanumeric code in the form of ANA NAN, in which “A” represents a letter of the alphabet, and “N” represents a number. It is an integral part of every postal address in Canada, and was designed to help sort mail, both mechanically and manually.

Rural areas are identified by a zero in the FSA (e.g., MOL 3K2).

For more detailed information, visit [Postal codes](#) of Addressing guidelines in the *Canada Postal Guide*.

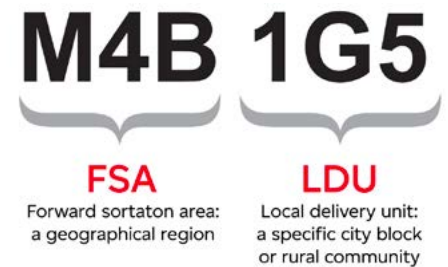

National Presortation Schematic (NPS)

The National Presortation Schematic (NPS) indicates how mail is distributed through specific Canada Post facilities. It lists all Forward Sortation Areas (FSAs) and shows how to consolidate mail into groupings and containers. The four NPS levels of consolidation are:

Level	Level 1 – DF	Level 2 – City	Level 3 – DCF	Level 4 – FCP
Consolidation	Delivery Facility	City	Distribution Centre Facility	Forward Consolidation Point

Any mail items that cannot be consolidated into one of these four levels will be consolidated as Residue.

Canada Post updates the NPS monthly to reflect the changes in Canada’s addresses. These monthly updates also appear in presortation software recognized by Canada Post. For detailed information, visit canadapost.ca/nps.

Sequencing mail items

Sequence your mailing by postal codes according to the National Presortation Schematic (NPS).

You may use a spreadsheet application, such as Microsoft Excel, in conjunction with the NPS to presort your mailings.

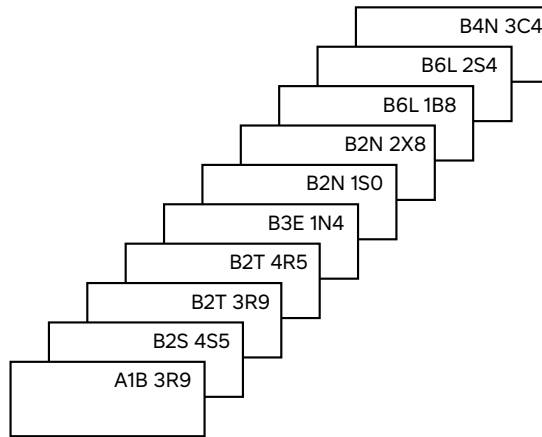

Grouping and identifying mail items

All items in a mailing must be part of a grouping. All groupings (except Residue) must have a minimum of six items. If this minimum requirement is not met, the items are consolidated to the next level.

Levels of groupings

Type of groupings	Presortation software groups mail items that have a common destination and/or sortation
NPS Level 1 – Delivery Facility (DF)	Group all items delivered from the same postal station or letter carrier depot (a DF grouping).
NPS Level 3 – Distribution Centre Facility (DCF)	Group all items delivered in the same area, such as a city and surrounding area (a DCF grouping).
NPS Level 4 – Forward Consolidation Point (FCP)	Group all items delivered in the same province (an FCP grouping).
Residue	Place all remaining items into a Residue grouping.

Note: See [Appendix D](#) for illustrations on how to group your mailing for deposit.

Bundling

A bundle is a group of mail items identified and secured together by strapping (e.g., elastic bands, string, or plastic straps) or by shrink-wrapping.

Once your mail has been presorted, make sure it can withstand handling. Preserve the integrity of your groupings by separating them in their containers, using one of the following acceptable methods: Bundling, Separator Cards and Edgemarking.

When using bundling as a separation method, DCF, FCP and Residue bundles must be identified with a bundle label (also called a facing slip). DF bundles do not require labels.

Type of mailing	Maximum bundle thickness	Minimum number of items per bundle
Standard	100 mm (4 in.)	6
Oversize	200 mm (8 in.)	6

When a bundle exceeds the maximum thickness and there are sufficient items to create a full second bundle, it is preferable to split the total number of items into two equal bundles, rather than create one full bundle and one very small bundle. For example, if there is a Standard bundle of 52 items with a thickness of 125 mm (4.9 in.), make two bundles of 26 items.

The maximum thickness takes precedence over the minimum number of items. The last Residue bundle has no minimum number of items, although it still must follow the specifications for maximum thickness per bundle.

Bundle labels

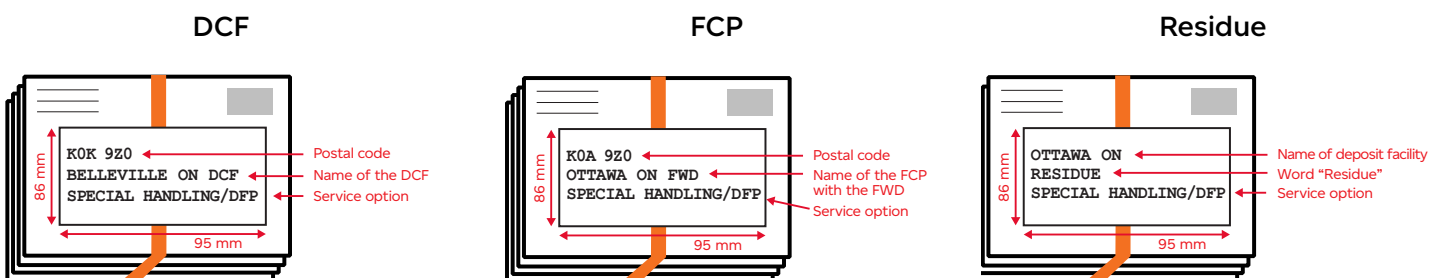

Category	DCF	FCP	Residue
Routing information on bundle labels	<ul style="list-style-type: none"> Postal code of the DCF, as per the NPS (e.g., KOK 9Z0) Name of the DCF (e.g., BELLEVILLE ON DCF) Service option (Delivery Facility Presort) 	<ul style="list-style-type: none"> Postal code of the FCP, as per the NPS (e.g., KOA 9Z0) Name of the FCP with the forward abbreviation FWD (e.g., OTTAWA ON FWD) Service option (Delivery Facility Presort) 	<ul style="list-style-type: none"> Name of the deposit facility (e.g., OTTAWA ON) The word "RESIDUE" Service option (Delivery Facility Presort)

Additional information may appear above or below the routing information as long as the routing information is more prominent.

Securing bundles

The **strapping material** must be strong and tight enough to hold the bundle together, without the contents sliding, when held vertically.

Size/item	Strapping requirement
Standard items Oversize items only for bundles placed in Level 1 (DF) containers	Single strapping <ul style="list-style-type: none">• Plastic or paper strapping material• Elastic bands when placed in hard-sided containers or customer-supplied boxes• It is recommended, but not mandatory, to apply the strapping to the shorter dimension of the bundle.
Oversize except for bundles placed in Level 1 (DF) containers	Double strapping <ul style="list-style-type: none">• Strings or manually applied plastic straps.

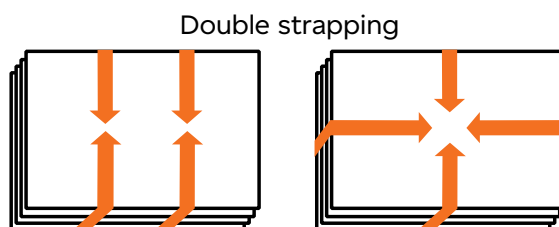
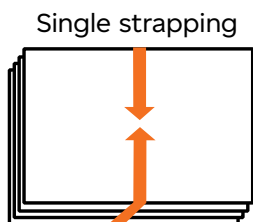

If your mail items are bound using spines, to create an even bundle, you may place the bottom half and top half of the bundle with their spines facing in opposite directions.

Note: Shrink-wrapping is an acceptable method of bundling for Oversize items.

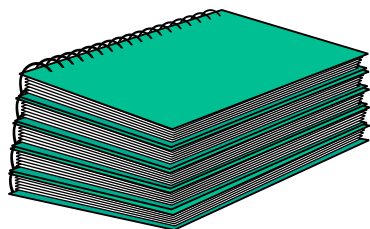

Acceptable

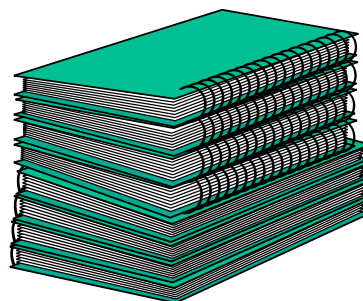

Preferred

Separator cards

- Be made of thin, rigid cardboard of any colour (a weight of 120 to 160 grams per square metre)
- extend at least 20 mm (0.8 in.) above the mail items
- be at least 155 mm (6.1 in.) wide
- be placed in front of the first mail item in each grouping. If a grouping is too large to fit into one container, a second separator card is required at the front of the second container.

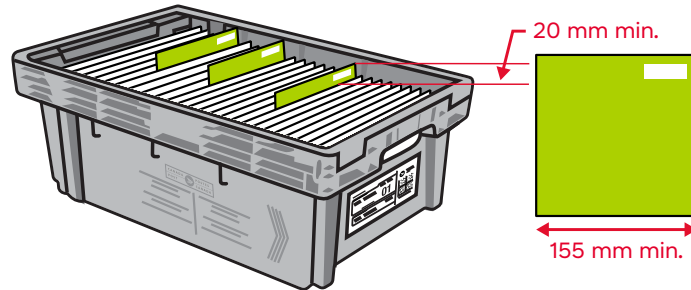

When using **separator cards** as a separation method, you must identify each DCF, FCP and Residue grouping on the part of the separator card visible above the mail items. The following information must be provided.

Category	For DCF groupings	For FCP groupings	For Residue groupings
Required information	<ul style="list-style-type: none"> • Postal code of the DCF, as per the NPS (e.g., K0K 9Z0) • Name of the DCF (e.g., BELLEVILLE ON DCF), and • The service option Delivery Facility Presort 	<ul style="list-style-type: none"> • Postal code of the FCP, as per the NPS (e.g., K0A 9Z0) • Name of the FCP with the forward abbreviation FWD (e.g., OTTAWA ON FWD) • The service option Delivery Facility Presort 	<ul style="list-style-type: none"> • Name of the deposit facility (e.g., OTTAWA ON) • The word “RESIDUE” • The service option Delivery Facility Presort

Edgemarking

The following requirements must be met:

- their colour significantly contrasts with that of the mail item
- the same colour is used for edgemarking the entire mailing
- the edgemarking begins approximately 40 mm (1.6 in.) from the upper-right edge of the mail item.

The edgemarks should be approximately 20 mm (0.8 in.) long, separated by a gap of approximately 25 mm (1 in.):

- the marking nearest the upper-right edge indicates a Delivery Mode Direct (DMD) grouping
- the additional markings indicate Delivery Facility (DF), Distribution Centre Facility (DCF) and Forward Consolidation Point (FCP) groupings.

It is acceptable for DCF and FCP groupings to have only two marks, but the marks must be in the DMD and DF locations.

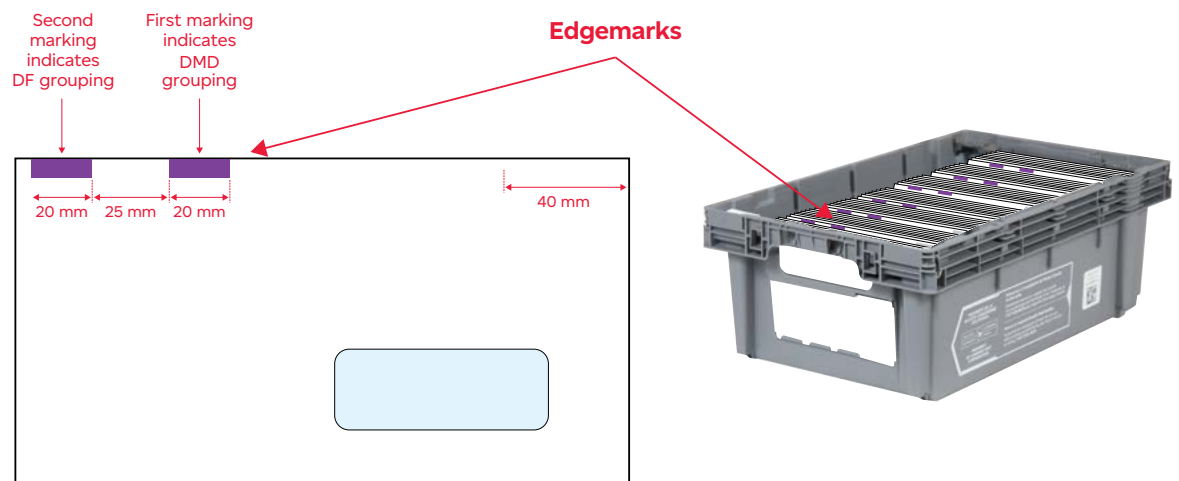

Filling containers

To help mitigate operator injuries when our employees are processing your mail, we are requesting that you do not overfill containers. We recommend 50 mm (2 in.) of space be left in a container to allow an operator to remove the mail. A simple way to do this is to tilt the Letterflatainer (LFT) on an angle so that the envelopes gravitate downward, when about 50 mm (2 in.) remain, the container is at capacity. This practice also helps to protect your mail items from damage.

Minimum requirements for filling containers

Consolidation level	If only one container to a destination	If multiple containers to a destination	
	Fill to capacity of:	All containers except the last, fill to capacity of:	Last container, fill to capacity of:
Level 1 – DF	50%	95%	No minimum
Level 2 – City	70%	95%	No minimum
Level 3 – DCF	70%	95%	No minimum
Level 4 – FCP	50%	95%	No minimum
Residue	No minimum	95%	No minimum

Preserving integrity of mail preparation

For any container with less than 95% of capacity, when using:

- **separator cards** or **edgemarking** as a separation method, you must use packing
- **bundle with strapping** as a separation method, we recommend adding packing

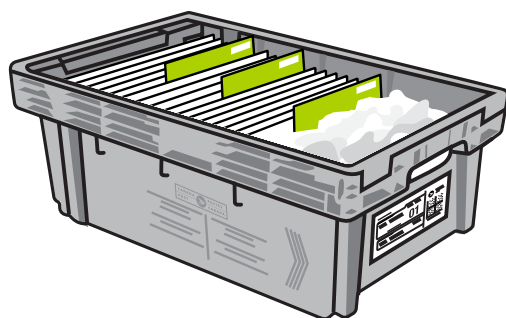

Labelling containers

All containers must be labelled with their destination details using routing information from the National Presortation Schematic (NPS). Correctly labelling your containers will ensure your mail is directed to the appropriate work centre within a Canada Post facility.

Routing information

Container labels must be bilingual and must include the following details:

- the service name (e.g., Publications Mail/Poste-publications)
- the service option (Delivery Facility Presort/Tri préliminaire par installation de livraison)
- the following NPS routing information (on all but Residue containers):
 - the facility postal code (e.g., K1G 2C0)
 - the facility name (e.g., OTTAWA)
 - the province, in abbreviated form (e.g., ON), and the routing destination (e.g., LCD Centretown).

Note: Labels for Residue containers must contain the facility name and the word “Residue”.

Example of container labels

If you are using Canada Post-supplied containers, insert container labels into the label holder prior to depositing your mailing.

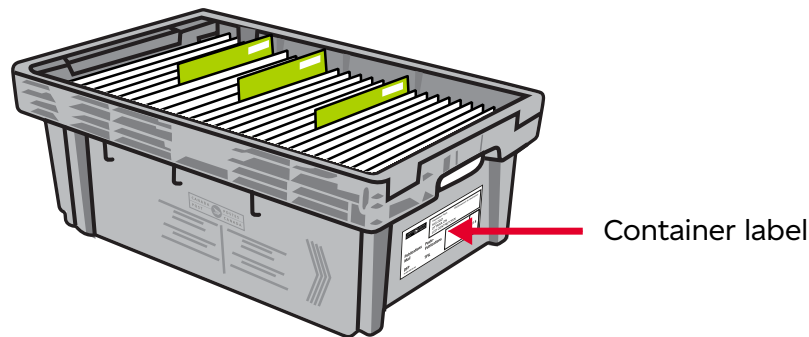

Note: The National Presortation Schematic (NPS) does not provide the Rural Delivery Facility details that are required on the container label. These Rural Delivery Facility postal codes can be found in the destination address on the mail item (addressee’s postal code) or at Canada Post – Urban and rural delivery area counts and maps under provincial “Rural Counts”.

If you are using customer-supplied cardboard containers, affix a container label to the side of each container. You can order self-adhesive labels online at canadapost.ca/obc under form number 33-086-732 or by calling 1-888-550-6333.

For customers using SERP software to prepare their Delivery Facility Presort mailing, a 2D barcoded container label will automatically be generated. Labelling the container with a 2D barcoded label is optional.

Placing containers in shipping units

Shipping units (monotainers and pallets – also referred to as skids) are used to group containers or to Brick-pile mail intended for one Order or bound for the same destination (e.g., all mail items for Vancouver arrive on one pallet). This reduces the handling and helps ensure timely delivery.

Shipping unit type	Destination	Minimum	Maximum
Pallet	Any (when using containers)	<ul style="list-style-type: none">• 18 LFTs• 12 flats tubs, or• 500 mm (19.7 in.) (excluding height of pallet)	<ul style="list-style-type: none">• 48 LFTs, or• 32 flats tubs, or• 1.5 m (4.9 ft.) (including height of pallet)
Monotainer	Mail destined within the province of deposit	<ul style="list-style-type: none">• 18 LFTs, or• 12 flats tubs	<ul style="list-style-type: none">• 48 LFTs,• 24 flats tubs or contents may be piled up to 25 mm (1 in.) below the top of the monotainer
	Mail destined outside the province of deposit	<ul style="list-style-type: none">• 27 LFTs, or• 18 flats tubs	<ul style="list-style-type: none">• 48 LFTs,• 24 flats tubs or contents may be piled up to 25 mm (1 in.) below the top of the monotainer

Note: Detailed information on Brick-piling mail items can be found in [“Appendix A: Brick-piled Mail Items”](#).

Labelling shipping units

All pallets and monotainers must be labelled. This will ensure that your mail is directed to the appropriate facility within Canada Post's network. For customers using SERP software to prepare their Machineable Mail, a 2D barcoded shipping unit label is available and optional.

Labels must be white and meet the following requirements:

- measure 216 mm high x 279 mm wide (8.5 in. x 11 in.) in letter landscape or letter portrait format. Labels may also be prepared in legal portrait format 216 mm x 355 mm. (8.5 in. x 14 in)
- be printed in black in a font size large enough to occupy the entire label
- prominently display the facility name (which must be visibly larger than all other information)
- be visible on two sides on the pallet or monotainer.

Labels for Residue monotainers or pallets and all labels generated without the use of SERP software must display the name of the deposit facility and the word "Residue".

We recommend that the Order number be written on the label. For customers wishing to include other internal directives on the shipping containers, a label colour different than white is recommended.

Routing information

- Service name
- Service option
- NPS routing information (on all but Residue pallets or monotainers):
 - the postal code of the Canada Post deposit facility (e.g., K0A 9Z0)
 - the name of the facility (e.g., OTTAWA)
 - the province, in abbreviated form (e.g., ON), and routing designation (e.g., DCF)

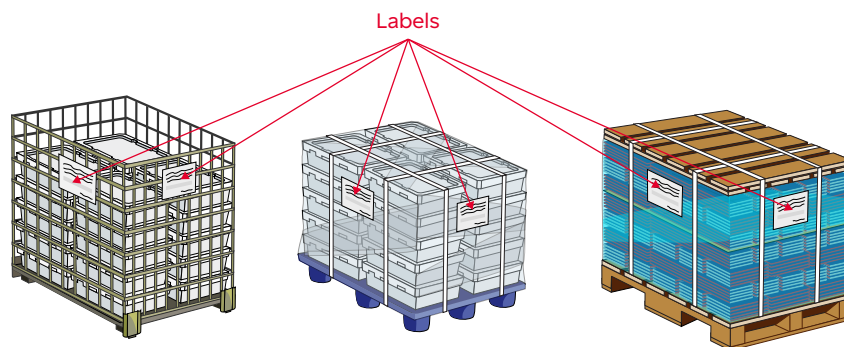

For customers wishing to include other internal directives on the shipping containers, a label colour other than white is recommended.

Securing pallets

All pallets must be securely fastened and structurally sound to safely handle and transport.

If using plastic pallets, it is recommended to apply four cross straps encompassing both the pallet bottom and the containers. Metal strapping is not permitted.



Stacking pallets or monotainers

Multiple pallets going to the same destination, as per the National Presortation Schematic (NPS), may be stacked on top of each other as long as they are secured together with straps. Stacking during storage and transportation uses warehouse space more efficiently. For example, where there are two pallets – one going to Vanier Station and one going to Merivale depot – these two pallets may be strapped together and identified to Ottawa (City consolidation).

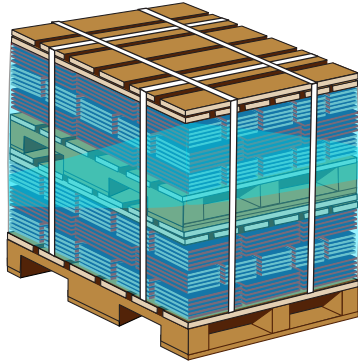

Pallets

Two pallets strapped together must not exceed 1.5 m (4.9 ft.) in height or 900 kg (1 ton) in weight.

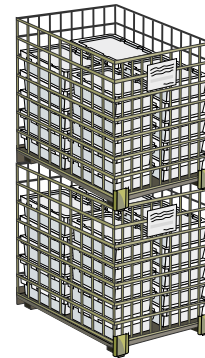

Monotainers

Two monotainers stacked together must not exceed 1,800 kg (2 tons); each monotainer must not exceed 900 kg (1 ton).

Note: Not all locations are equipped to process mail received in monotainers or pallets that are double-stacked. See the Find a Deposit Location tool at canadapost.ca/depositlocations to ensure the deposit location is properly equipped and capable of handling your mail.

Preparing bundles of Unaddressed copies

Publications Mail items only

Key requirements for preparing Bundles of Unaddressed Copies:

- may be included on the same Order as Machineable Mail, Special Handling or Delivery Facility Presort
- no minimum volume is required
- presortation is not required
- must bear the notation “DIRECT BUNDLE TO THIS ADDRESS” on or near the address label (otherwise the Bundles of Unaddressed Copies will not be accepted)
- must be segregated from individually addressed copies when deposited in order to expedite processing
- two or more back issues of a publication may be sent as a Bundle of Unaddressed Copies.



Commercial Mail
Creating
an Order

Launch a campaign and elicit a better response for every dollar of your budget



Commercial Mail

Creating an Order



How to place an Order

Description	Incentive Lettermail	Publications Mail	Business Reply Mail	International Incentive Letter-post
Order (SOM)	One order per SOM	Machineable Mail and Special Handling mail items may be included on the same Order. Delivery Facility Presort mail items cannot be combined with other preparing options.	N/A	Premium, Per Item or Standard cannot be combined on the same Order.
Mailing plan import file	N/A	yes	N/A	N/A
Scheduling	N/A	N/A	N/A	Must provide 24 hours notice when depositing 20,000 items or more
Sample of mail	N/A	Mandatory	N/A	N/A
Partial mailing	yes	yes	N/A	N/A
Downstream deposits	N/A	yes	N/A	N/A
Weighted average weight	A mailing may be comprised of items of varying weights – see Appendix E for calculation instructions	A mailing may be comprised of items of varying weights – see Appendix E for calculation instructions	N/A	N/A

Note: It is recommended that the number of containers is indicated on your Order.



Create your Order

An Order must be properly completed and transmitted electronically using the [Electronic Shipping Tools \(EST\)](#) (Online and 2.0 versions). Orders that are not transmitted electronically may be subject to a surcharge.

Provide a sample

You must submit for review one representative sample of each item with different physical characteristics (weight, size) on deposit. Otherwise, to avoid delaying or detaining the progress of mail, you agree that one sample item will be removed from the mailing for Canada Post's records and verification.

You are encouraged to have mail items verified for compliance prior to depositing them. This can be done by contacting a Commercial Service Network (CSN) Representative at 1-866-757-5480.

Mailing Summary and Mailing Details – For Publications Mail only

The Mailing Summary includes general information regarding you and the presortation software used for mailing. The Mailing Details document includes a breakdown of the mail preparation and presortation information.

Canada Post and the SERP (Software Evaluation and Recognition Program) vendors have developed a file import functionality, the Presort Mailing Plan Import Program, which reduces the amount of data that you need to enter when preparing Orders.

The functionality allows you to import your Mailing Plans directly into the EST, using both the EST 2.0 and the EST Online versions. The SERP software will also generate the hard copy Mailing Summary and Mailing Details reports which will only be required upon request by us. Visit canadapost.ca/presortationsoftware for a list of recognized presortation software vendors. Information on how to create a machineable mail import file (optional) is available at canadapost.ca/est.

Partial mailing (not applicable for International Incentive Letter-post)

If a mailing is deposited in more than one day:

- you must select the Partial Mailing option if using the EST or check the appropriate box on the manual Order
- the total mailing cost must be declared on the Order for the entire mailing accompanying the first portion of the mailing. We will invoice you for the total mailing as declared on the Order
- the Order, along with one representative sample of each item (not applicable for Incentive Lettermail), must be deposited with the first partial mailing
- each subsequent partial mailing must be accompanied by the applicable copy of the Order for the deposit location identified on the Order
- each partial mailing must meet the minimum volume requirement: Machineable Mail – 100 items (1,000 items for Incentive Lettermail); Special Handling mail – 1,000 items; Delivery Facility Presort – 50 items
- all partial mailings within an Order must be deposited in full no later than 15 business days (7 calendar days for Incentive Lettermail) from the first deposit date.

Downstream deposits

Applicable for Publications Mail service only, for downstream deposits:

- you must select the Downstream Mailing option when using the EST 2.0 (not available when using the EST online) or check the appropriate box on the manual Order
- the Order, along with one representative sample of each item, must be deposited with the primary mailing as indicated in the “Outlet” field of the Order
- the copy of the Order for the declared deposit location identified on the Order must accompany each subsequent individual downstream shipment.
- the downstream deposit location is considered the origin for Local, Regional and National designations for Special Handling mailings.



Commercial Mail Depositing

Last step in getting your brand into
customers' hands



Commercial Mail

Depositing



Items must be deposited in accordance with the requirements set out in the Agreement and its supporting documentation. If mail items are deposited under a particular preparation option (Machineable Mail and Special Handling) and do not meet the requirements for that option, you may choose to:

- pay a surcharge, if applicable;
- re-work the mailing so as to meet the requirement;
- have the mail processed using another option, if the items qualify; or
- use another appropriate Canada Post service.

Required at the time of deposit

Description	ILM	PUBS	BRM	IILP
One printed copy of the Order	yes	yes	N/A	yes
A sample* identical to the item being mailed (including enclosures, attachments and wrapping)	N/A	yes	N/A	N/A
Mailing plan (Special Handling mail must include the exportable file of mailing plans generated and imported into the EST)	N/A	yes	N/A	N/A

* A representative sample for each variation (weight, size, content) must be provided at the time of deposit. Otherwise, to avoid delaying or detaining the progress of mail, you agree that one sample item will be removed from the mailing for Canada Post's records and verification.

Find a Deposit Location

The Find a Deposit Location tool is available at canadapost.ca/depositlocations to help you identify the right deposit location for your mailing based on postal code, mail type and quantity. The tool will provide you more helpful information, such as the deposit location address and deposit location cut-off times.

Items deposited after the deposit location cut-off times will be considered deposited on the next business day.

Deposit location types

We have assessed the capabilities of our deposit locations to ensure they are properly equipped and capable of handling your mail efficiently and on time. The type and volume of mail which can be accepted at these facilities are outlined for each deposit location type.

Deposit location type

Receipt verification unit (RVU)

Accept all products and all volumes with the exception of machineable mail (i.e., mail prepared in accordance with the Machineable Mail specifications). Not all RVUs can accept all types of Machineable Mail.

Commercial deposit centre (CDC)

Accept, verify, and process commercial mailings with the exception of Machineable Publications Mail (customers will be referred to the nearest RVU). Commercial mailings deposited at a CDC will continue to be processed at a Canada Post mail processing plant. Customers exceeding the maximum volumes will be referred to the nearest RVU.

Corporate post office

Accepts all commercial products except Machineable Publications Mail. Customers exceeding the maximum volumes will be referred to the nearest CDC or RVU.

Where to deposit your item

All items must be deposited with an authorized representative at the deposit location selected on the Order. Items cannot be deposited in street letter boxes or other mail receptacles.

Daily maximum volumes of mail apply for certain types of deposit locations.

Receipt verification unit	Commercial Deposit Centre (CDC) ¹			Corporate Post Office ¹	
	Level 1	Level 2	Level 3	Level 1	Level 2
No maximum	2 shipping units ²	3 shipping units ² (monotainers/pallets)	7 shipping units ²	5 containers	12 containers

1. These locations are not equipped to process mail received in monotainers or pallets that are double-stacked.

2. A monotainer can accommodate approximately 48 LFTs (40 letterflatainers with lids) or 24 flats tubs.

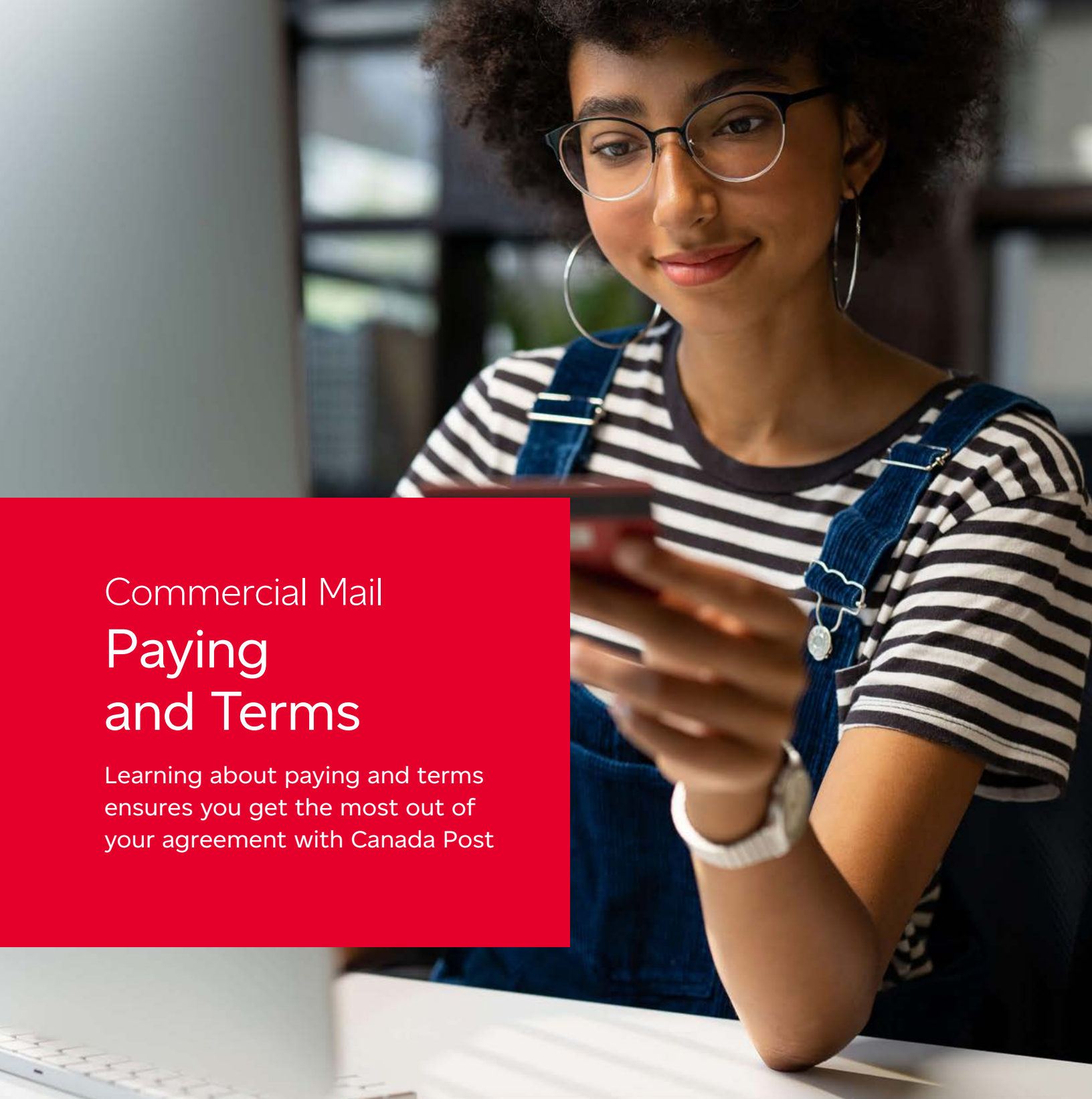

Commercial Mail Paying and Terms

Learning about paying and terms ensures you get the most out of your agreement with Canada Post



Commercial Mail

Paying and Terms

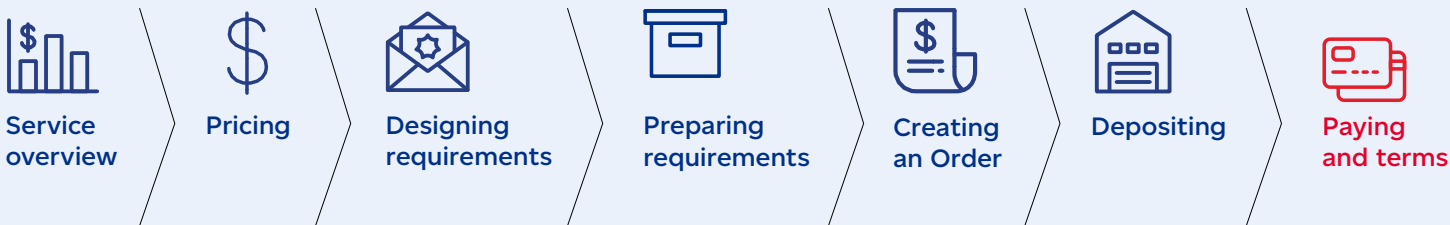

Paying for your mailing

1 Application

The information found in “Paying for Your Mailing” applies to the following products and services: Incentive Lettermail, Publications Mail, Business Reply Mail and International Incentive Letter-post.

2 Payment Method Options

The following describes various payment method options acceptable to Canada Post. However, not all options may be accepted at all Canada Post facilities.

2.1 Use of Account

2.1.1 Incentive Lettermail, Publications Mail and International Incentive Letter-post

- Customers with pre-approved credit terms may elect “ACCOUNT” as a method of payment if the mailing is to be invoiced and charged to their account and for applicable credit terms to apply. See [Section 3 “Pre-Approved Credit Terms – Account”](#) for details.
- Customers who do not qualify for credit terms must provide full payment at the time of mailing. Otherwise, the mailing will not be accepted. See [Section 5 “Proof of Payment and Use of Postal Indicia”](#) for details.

2.1.2 Business Reply Mail

Customers must use an Account to access and pay for Business Reply Mail services. See [Section 3 “Pre-Approved Credit Terms – Account”](#) for details.

3 Pre-Approved Credit Terms – Account

3.1 Use of Account

Customers with pre-approved credit terms may elect “ACCOUNT” as a method of payment if the mailing is to be invoiced and charged to their account and for applicable credit terms to apply or if Business Reply Mail services are used. Following approval by Canada Post and continued credit worthiness as determined by Canada Post, at its discretion, credit terms of net 15 days from date of invoice will apply.

3.2 Invoice

For Incentive Lettermail, Publications Mail and International Incentive Letter-post, if Account was selected to pay for a mailing, Canada Post will provide the customer with an invoice that summarizes the charges posted to their account. The charges reflected on the invoice are a summary of the mailings/Orders (Statements of Mailing) that a customer has submitted to Canada Post with the following exceptions:

- a) Customers who elect to pay for services via credit card using our online tools can receive an invoice through our Invoice Notification program. Please contact Credit Management Group at 1-800-267-7651 to sign up. For more information on credit card as a payment option, see [Section 4.2 “Credit card”](#).
- b) Customers can access a copy of their invoice through our free online service. See [Section 3.6 “Manage My Accounts”](#) for further information.

Canada Post reserves the right to include on a current invoice any amount not previously billed for invoices dated 90 days prior to the date of the current invoice.

For Business Reply Mail, Canada Post will provide the customer with an invoice for Business Reply Mail that summarizes the charges posted to their account. The charges reflected on the invoice are either of the annual fee and/or of a summary of the Business Reply Mail items returned to the customer. Large volume receivers of Business Reply Mail are eligible to receive their invoices on a weekly basis. To qualify for weekly billing, customers must receive over 35,000 items of Business Reply Mail annually.

To sign up for weekly invoicing, please contact the Credit Management Group at 1-800-267-7651.

For all services, the customer should advise the Credit Management Group at 1-800-267-7651 of any discrepancies. Invoice/billing discrepancies must be brought to Canada Post’s attention within 90 days of the date of the invoice, after which time such invoice will be deemed accepted by the customer.

In the event that Canada Post is requested to respond to any invoicing discrepancy initiated by, (i), the customer or, (ii), any third party on behalf of the customer within the period mentioned above, Canada Post reserves the right to charge the customer an adjustment and/or investigation fee(s) (the investigation fees will apply in cases where Canada Post determines that disputed charges were correctly calculated on the original invoice or Order).

Canada Post reserves the right, at its sole discretion, to refuse a request for a refund or credit of charges for any Order when such request is made by any party other than the payer.

3.3 Account settlement

Accounts may be settled using one of the following:

- Pre-authorized bank payment
- Pre-authorized credit card payment, upon Canada Post approval
- Online payment (see [Section 3.6 “Manage My Accounts”](#))
- Payment by cheque or money order.

Customers wishing to sign up for pre-authorized or online payment need to complete and submit the applicable form, which can be obtained at canadapost.ca/caf or from a Canada Post Representative.

Cheques or money orders must be made payable to “CANADA POST CORPORATION”, include the Canada Post customer number and be accompanied by the remittance information. Payment must be sent to the following address:

PAYMENT PROCESSING
CANADA POST
2701 RIVERSIDE DR
OTTAWA ON K1A 1L7

Customers should allow up to three business days for payment processing.

3.4 Past due amounts and administration fees

3.4.1 Late payment

Past due amounts will be subject to a late payment fee. The late payment fee will be calculated at a rate of 1.5% per month (18% per annum). Canada Post may amend the late payment fee rate at any time upon Notice to the customer.

If an amount becomes past due, Canada Post may elect to apply any money otherwise received from the customer or any money due to the customer by Canada Post toward bad debts first. Such right of set off shall be without prejudice and in addition to any other rights Canada Post may have.

No interest will be paid by Canada Post on any funds held in the customer’s account.

3.4.2 Account Administration Fees

Return payments: An administrative fee will be applied on any payment that is dishonoured for any reason, including a payment returned due to Non Sufficient Funds (NSF). The customer agrees to reimburse Canada Post for all costs, including legal fees and bank charges, incurred as a result of late or dishonoured payments.

Document copies: Customers requiring duplicate copies of invoices, may access them through our free online service. See [Section 3.6 “Manage My Accounts”](#) for further information. Requests for duplicate invoices or other documentation (e.g., Order [Statement of Mailing], Packing Slips, etc.) fulfilled through our Account Management Group are subject to service fees for items up to six months from their creation date. Additional fees will apply for items older than six months, if available.

Corrections: Customers requiring corrections to Orders, invoices, or customers transmitting invalid or late electronic Orders, where Canada Post is not responsible, are subject to additional service fees.

Canada Post reserves the right to amend administration fees at any time without prior notification. A list of account administration fees is available upon customer request by contacting the Credit Management Group at 1-800-267-7651.

Investigations: In the event Canada Post is requested to investigate invoice discrepancies (including, but not limited to service guarantee failures), Canada Post may apply an additional fee for the number of disputed items submitted which Canada Post investigates and determines to be correctly charged as originally invoiced.

3.5 Statement of Account (SOA)

A Statement of Account (SOA) is provided monthly to the customer if the customer used their Account to pay for their mailing and their account was created before August 1, 2022. Statement of Account (SOA) summarizes each of the invoices processed and any related adjustments and payments made during the month, as well as any balance owing at the end of the month.

3.6 Manage My Accounts

The “Manage My Accounts” section available on our website at canadapost.ca provides a convenient and secure environment through which:

- Customers can access their account information online;
- Customers may view the status of their accounts and make payment online through the “Manage My Accounts” page;
- Customers can update credit card information online through “Manage My Accounts” under “Manage My Profile”.

4 Payment at Time of Mailing – No Credit Terms

This section applies to Incentive Lettermail, Publications Mail and International Incentive Letter-post. For Business Reply Mail, please refer to [Section 2.1.2 “Business Reply Mail”](#) and [Section 3 “Pre-Approved Credit Terms – Account”](#).

4.1 Overview of payment method options at time of mailing

For customers without pre-approved credit terms, full payment at the time of mailing must be made by:

- certified business cheque (payment by uncertified business cheque is subject to approval by Canada Post)
- cash (post offices only)
- money order
- credit card (some conditions apply). See [Section 4.2 “Credit card”](#). For updating credit card information only, please refer to [Section 3.6 “Manage My Accounts”](#)
- debit card (some conditions apply)
- meter (some conditions apply). See [Section 4.3 “Postage meter”](#).

4.2 Credit card

VISA, MasterCard and American Express credit cards may be available as a method of payment option:

- when the Canada Post Electronic Shipping Tools (EST) is used and the customer chooses credit card. The credit card will be charged at the time of mailing
- as set out in the *Canada Postal Guide* or other material published by Canada Post and of general application to Canada Post’s customers, as amended from time to time.

Note 1: Some conditions and restrictions apply.

Note 2: With the exception of customers enrolled for pre-authorized credit card payment, credit cards are not accepted in payment of invoices or for settlement of Account balances.

Note 3: Credit cards are accepted at Canada Post facilities only where credit card authorization facilities are available.

4.3 Postage meter

Payment by postage meter impression is an available method of payment only for the following:

- Standard Lettermail
- Other Lettermail (Non-Standard and Oversize)
- Incentive Lettermail (Standard up to 50 g and Oversize up to 100 g)
- U.S.A. Standard Letter-post
- U.S.A. Other Letter-post (Non-Standard and Oversize)
- International Standard Letter-post
- International Other Letter-post (Non-Standard and Oversize).

Note: Payment by postage meter impression on the item cannot be used to pay for Publications Mail or International Incentive Letter-post items.

The customer may elect “METER” as a method of payment for qualifying items by placing a postage meter impression on each item to sufficiently cover the cost of mailing.

Incentive Lettermail: The name of the service must appear to the left of the postage meter impression in English and French.

Note: For more information on postage meter impressions, visit *Paying For Your Mailing*, [Section 2.2 “Postage Meter Impression”](#) of the *Canada Postal Guide*. See [Section 5 “Proof of Payment and Use of Postal Indicia”](#) for additional information.

5 Proof of Payment and use of Postal Indicia

Incentive Lettermail and Business Reply Mail items must bear the appropriate postal indicia on the addressed side of each item for all methods of payment options, unless the items are being paid using a postage meter impression. Payment by postage meter refers to payment by placing a postage meter impression on each item of mail qualifying for meter payment (see [Section 4.3 “Postage meter”](#)).

For Publications Mail, the use of a postal indicia or the applicable “Basic Identifying Information” is required as a proof of payment.

Note 1: Postal Indicia requirements and artwork can be obtained through a Canada Post Representative or electronically at canadapost.ca/postal-indicia.

Note 2: Business Reply Mail artwork can be obtained at canadapost.ca/obc through the Business Reply Mail Artwork Online tool, which includes the postal indicia.

6 Authorized Users

The customer may wish to allow another party to use their Agreement or customer number. Please refer to the Agreement Activation Form and to [Section 7 “Definitions”](#) and [Section 15 “Authorized Users \(excludes Business Reply Mail service\)”](#) in the [General Terms and Conditions](#). A Canada Post Representative can explain under what conditions this is possible and who may be considered as an Authorized User.

Note: For the Business Reply Mail (BRM) service: authorized users are not permitted.



Commercial Mail
**General Terms
and Conditions
with a Standing
Offer Agreement**



Commercial Mail

General Terms and Conditions with a Standing Offer Agreement

Canada Post is in the business of providing mail and other related delivery products and services. The parties wish to set out the terms by which Canada Post will provide and the Customer will use such products and services. In consideration of the mutual obligations specified in this Agreement, the parties agree to the following:

7 Definitions

7.1 “Affiliate” means an affiliated body corporate as defined by the [Canada Business Corporations Act](#) as amended from time to time.

7.2 “Agreement” has the meaning set out in [section 19](#).

7.3 “Agreement Year” means 12 consecutive calendar months falling between two anniversary dates.

7.4 “Applicable Published Prices” means, with respect to each Product and Service, the applicable prices, including any applicable fees, charges or surcharges, and less any applicable rebates, set by Canada Post and in effect at the time of mailing, as published and/or made available by Canada Post for general application to its Customers, as amended from time to time.

7.5 “Authorized User” means a party designated by the Customer and who is approved by Canada Post to have access to the Products and Services offered under this Agreement. Unless otherwise specified in this Agreement, an Authorized User has full access to the Products and Services offered under this Agreement.

7.6 “Business Day” means a day other than Saturday, Sunday, a statutory holiday and any day normally observed as a holiday by Canada Post.

7.7 “Customer-Developed/Third-Party Shipping system” means the suite approved by Canada Post, which allows for automated preparation of shipping documentation, including labels, and contains other features to facilitate shipping with Canada Post, and which is further described at [canadapost.ca/eLink](#).

7.8 “Customer Guide” means the document of the same name issued by Canada Post for each of the Products and Services, as amended from time to time.

7.9 “Electronic Goods” means electronic devices or their mechanisms, memory and all ancillary or related data storage devices, including but not limited to computers, televisions, tablets, cellular phones, smartwatches, audio equipment, media recording devices, cameras, camcorders, GPS and car audio equipment.

7.10 “Electronic Shipping Tools (EST)” means the software system made available under license by Canada Post or a third party shipping system approved by Canada Post, which allows for automated preparation of shipping documentation including labels, and contains other features to facilitate shipping with Canada Post, and which is further described at [canadapost.ca/est](#).

7.11 "Fragile Items" means items of an inherently fragile nature such as, but not limited to, glass, framed glass, mirrors, crystal, ceramics, pottery, porcelain and china, perishable items or items requiring refrigeration or temperature-controlled transport.

7.12 "Item" means a single item or mail piece prepared and mailed using one of the Products and Services in accordance with this Agreement.

7.13 "Products and Services" means any of the Products and Services, with the exception of Priority Worldwide service, offered for sale as described in the *Canada Postal Guide* or other Canada Post publication of application to commercial Customers generally, including the applicable Customer Guide.

7.14 "Subsidiary" means a subsidiary body corporate as defined by the [Canada Business Corporations Act](#) as amended from time to time.

7.15 "Term" means the period set out in the Customer Guide for each Product or Service.

7.16 Other terms not specifically defined in this Agreement have the meanings defined in the applicable Customer Guide, the *Canada Postal Guide* or other Canada Post publication of application to Customers generally.

8 Canada Post's Obligations

8.1 Canada Post agrees to deliver Items of each Product and Service mailed under this Agreement according to the applicable delivery standards set out in the Customer Guide or canadapost.ca/deliverystandards and of general application to Canada Post's Customers, as amended from time to time. Unless expressly stated in this Agreement, delivery standards established by Canada Post for its Products and Services are not performance guarantees.

8.2 Canada Post agrees to provide or make available to the Customer upon execution of this Agreement, the *Canada Postal Guide* or other material published by Canada Post, including the Customer Guide corresponding to a particular Product or Service of general application to Customers, and any subsequent amendment thereto.

9 Customer's Obligations

9.1 The Customer agrees to prepare and mail Items in accordance with this Agreement.

9.2 The Customer agrees to purchase and pay for the Products and Services at the Applicable Published Prices specified in the Price Sheet, subject to any applicable rebates plus all applicable fees, charges, surcharges and taxes. The Applicable Published Prices charged are subject to verification, correction and adjustment for any applicable fees, charges, surcharges and taxes.

9.3 The Customer agrees to pay for the Products and Services purchased using the payment method(s) specified in the applicable Customer Guide.

9.4 If so specified in the Agreement, the Customer agrees to meet the minimum volume of Items required per deposit or per annual commitment for each Product and Service.

9.5 If so specified in the Agreement for a Product or Service, the Customer shall include an electronic order, in such form as approved or stipulated by Canada Post, with each mailing.

9.6 Use of Marks and Indemnification Obligation

Except as specifically provided for in this Agreement, no party shall use any trademarks, trade names, official marks and any other rights of another party (“the Marks”) without the prior written authorization of such other party. Nothing contained in this Agreement is intended as an assignment or grant of any right, title or interest in or to the Marks. The Customer warrants that it is the owner or licensed user of the Marks, and has the authority to and does grant Canada Post and its Designated Representative the right to use such Marks as required to perform under this Agreement. Any use by the Customer of Canada Post’s intellectual property or third-party intellectual property used under licence by Canada Post, including, but not limited to usage of any Canada Post logos or trade names must be approved in writing in advance by Canada Post.

The Customer shall indemnify Canada Post from any and all claims, demands, loss or damage suffered by Canada Post and its Designated Representative as a result of, or in any way connected with the artwork (including Marks) provided by or on behalf of the Customer.

9.7 Customized Postal Indicia Use of Images

The image submitted must be suitable for family audiences.

The image cannot contain any trademarks, trade names, official marks and any other rights of another party (“the Marks”) without the prior written authorization of such other party. The Customer warrants that it is the owner or licensed user of the Marks, and has the authority to and does grant Canada Post and its agents the right to use such Mark’s as required in performing its obligations.

The Customer shall indemnify Canada Post from any and all claims, demands, loss or damage suffered by Canada Post and its agents as a result of, or in any way connected with the artwork (including Marks) provided by or on behalf of the Customer.

In the event that an image depicts one or more individuals is submitted, the Customer represents and warrants that it has the permission of the individual(s) depicted to use the image. In the case of an image of a celebrity or an image that appears to have been taken without the knowledge of the individual being depicted, the Customer may be asked to provide written proof of permission (by way of email or mail) to use the image.

Canada Post reserves the right to refuse any proposed Customized Postal Indicia design that it, at its sole discretion, deems unsuitable for any reason.

Items with Customized Postal Indicia are not considered postage paid and must be inducted with an Order (Statement of Mailing) at a Canada Post facility.

Customized Postal Indicia products designs are subject to change without notice.

10 Exclusive Privilege

10.1 The Customer acknowledges that Canada Post has, pursuant to and in accordance with the [Canada Post Corporation Act](#) and Regulations, the sole and exclusive privilege of collecting, transmitting and delivering letters within Canada. Without prejudicing any other rights or remedies Canada Post may otherwise have, the Customer agrees that Canada Post may terminate the Agreement if the Customer, or any Authorized User of the Customer, directly or indirectly contravenes this privilege. If the Agreement is terminated for contravention of this privilege, then, in addition to any amounts otherwise due, the Customer shall pay to Canada Post an amount equal to the difference between the amount paid or payable for all Items mailed up to the date of termination and the amount that would have been payable for that volume, at current undiscounted prices, that would have been payable, but for this Agreement.

11 Criteria for Qualification

11.1 The Customer is responsible for ensuring that all Items comply with the requirements set out in this Agreement and, except for Priority Worldwide services, the [Canada Post Corporation Act](#) and Regulations; and, for international Items, the Universal Postal Union (UPU) requirements and any receiving postal administration or designated operator requirements and the laws of the country of destination, all as may be amended from time to time. Items not complying with these requirements may not be mailed under this Agreement. Canada Post retains the right to refuse to accept any Item that it, in its sole discretion, deems unacceptable.

11.2 Mailings not previously approved by Canada Post and assessed by the Customer, or on behalf of the Customer, are subject to pricing verification and correction by Canada Post.

11.3 Items presented for mailing to Canada Post may be verified to determine compliance with applicable Terms and Conditions. Items determined not to be compliant may, at the discretion of Canada Post, be:

- a) returned at the Customer's expense, to be made compliant by the Customer, where possible;
- b) processed and charged at the next or most appropriate Product or Service category, where available;
- c) subject to a surcharge; or
- d) refused for mailing.

11.4 Canada Post may correct the Customer's order documentation if it contains incomplete or incorrect information.

11.5 Canada Post shall not be responsible for meeting any delivery standards, where applicable, for delays arising from the mailing of non-compliant Items.

12 Surcharges

12.1 Items mailed under this Agreement may be subject to one or more of the following surcharges:

- Surcharges for non-compliance with mail specification or preparation requirements;
- Fuel surcharge;
- Mailing tube surcharge;
- Oversize (OS) surcharge;
- Unpackaged surcharge;
- Non-transmitted Order surcharge;
- Non-manifested Item surcharge.

Details regarding such surcharges are set out in the applicable Customer Guide. Canada Post may amend the surcharges at any time immediately upon Notice to the Customer.

12.2 Receiving Postal Administration or Designated Surcharge

The Customer agrees to reimburse Canada Post for any incremental terminal dues or costs such as, but not limited to, bulk mail and remail charges that are applied by the receiving postal administration or designated operator, as specified in the Universal Postal Union Convention.

13 Currency

13.1 Unless expressly noted to the contrary, all monetary amounts are stated and shall be paid in Canadian currency.

14 Audits

14.1 On request, the Customer shall permit Canada Post and its authorized representatives access to its premises and, if applicable, those of Authorized Users and the Mailer, On Behalf Of the Customer, during the Term, and for a reasonable period of time after the expiry or earlier termination of this Agreement. The Customer agrees to facilitate Canada Post's access, examination and audit of the records, databases and information relating to the Items mailed under this Agreement and the Customer's obligations, including, if applicable, those of Authorized Users and the Mailer, On Behalf Of the Customer, under this Agreement.

15 Authorized Users (excludes Business Reply Mail service)

All references to the Customer include the Customer's Authorized Users and any actions taken by an Authorized User are deemed to be the actions of the Customer. The designation of Authorized User is subject to the approval of Canada Post. The List of Authorized Users is set out in an appendix to this Agreement.

The Customer may amend the List of Authorized Users upon consent of Canada Post.

An Authorized User who ceases to be an Affiliate, Subsidiary or a franchisee of the Customer will no longer be entitled to mail Items under this Agreement as of the date upon which it ceases to be an Affiliate, Subsidiary or franchisee of the Customer. In the event that an Authorized User ceases to be an Affiliate, Subsidiary or a franchisee of the Customer, the Customer shall give Notice to Canada Post within 30 calendar days of such change in relationship.

The Customer is responsible for the compliance by each Authorized User with this Agreement. In the event that an Authorized User fails to pay for Products or Services provided under this Agreement, the Customer shall pay the amount owing.

16 Mailers, On Behalf Of

16.1 Canada Post will accept Items mailed by another party on behalf of the Customer, provided that the mailing of such Items complies with the Terms and Conditions of this Agreement. The Customer shall require a Mailer, On Behalf Of, to abide by the Agreement. The actions taken by the Mailer, On Behalf Of, are deemed to be the actions of the Customer.

17 Resale or Interlining

17.1 The Customer agrees that any Products and Services purchased under this Agreement are for the Customer's own use as an end user or for the use of an Authorized User. Unless otherwise expressly permitted by Canada Post, the Customer will not sell or permit the resale of any services or supplies received from Canada Post, nor use the Products and Services offered under this Agreement for the purposes of interlining. Interlining is the process in which a carrier uses another carrier's transportation service in the course of a continuous freight movement.

18 Assignment

18.1 The Customer shall not assign this Agreement without the prior written consent of Canada Post and any purported assignment without prior consent is void. Canada Post may assign the benefits of this Agreement or make any arrangements that would result in the performance, in whole or in part, of the obligations of Canada Post under this Agreement by a person other than Canada Post.

18.2 If the Customer amalgamates, merges or enters into a similar business combination with any other entity, including without limitation by means of

- a) acquisition of all or substantially all of the assets of another entity; or
- b) the sale of all or substantially all of the assets to another party, then, for the purpose of this Agreement, such amalgamation, merger or combination will be deemed to be an assignment requiring the prior written consent of Canada Post.

19 Entire Agreement and Alterations

19.1 All references to this Agreement shall be deemed to include:

- a) The Agreement Activation Form(s);
- b) These General Terms and Conditions;
- c) The applicable Customer Guide(s);
- d) The applicable Price Sheet(s);
- e) The Credit Application Form, if applicable;
- f) The *Canada Postal Guide*;
- g) Any appendices and any documents referenced therein;

all as may be amended from time to time.

19.2 Without limiting the generality of the above, in the event of any inconsistency between this Agreement, and any document other than the [Canada Post Corporation Act](#) or its Regulations, the terms of this Agreement shall prevail and be interpreted in the order of priority listed above.

19.3 No representations, warranties, negotiations or conditions, either verbal or written, will bind the parties except as expressly set out in this Agreement. Except as set out in the section on [“Waiver” below, no agent or representative of either party to this Agreement has authority to alter the provisions of this Agreement, and any such purported alteration shall not be binding.](#)

20 Waiver

20.1 Except as specifically stated in this Agreement, no waiver or amendment of this Agreement shall be binding unless executed in writing by the appropriate party's authorized representative. No waiver of any provision of this Agreement shall constitute a continuing waiver unless otherwise expressly provided. Acceptance of Items for mailing shall not constitute a waiver by Canada Post of the Customer's obligations under this Agreement.

21 Amendments

21.1 Canada Post reserves the right to modify, discontinue Products or Services, or otherwise amend this Agreement, including prices, by giving the Customer 30 calendar days' written Notice as specified in this Agreement.

21.2 Canada Post reserves the right to amend the *Canada Postal Guide* without Notice to the Customer.

22 Survival

22.1 The termination or expiry of this Agreement will not affect the survival and enforceability of any provision of this Agreement that is expressly or implicitly intended to remain in force after such termination or expiry.

23 Severability

23.1 If any part of the Agreement is unenforceable or invalid for any reason whatsoever, such part shall be severable from the remainder of the Agreement and its unenforceability or invalidity shall not affect the enforceability or validity of the remaining parts of the Agreement.

24 Governing Law

24.1 This Agreement is made subject to and in accordance with the [Canada Post Corporation Act](#) (the "Act"), R.S.C. 1985, c. C-10, as amended from time to time, and any of the Regulations, which are or may be from time to time made under the Act.

24.2 If the Customer's address is not in a Canadian province or territory, this Agreement shall be governed by, and interpreted under, the laws in force in the province of Ontario, Canada. The forum for any legal proceedings shall be the province of Ontario, Canada.

25 Excusable Delay

25.1 Except for the Customer's payment obligations, neither party shall be liable to the other for any failure to perform, or delay in the performance of, any obligation under the Agreement due to causes beyond its reasonable control, including, but not limited to, acts of God, epidemics, labour disruptions, failures or fluctuations in electrical power, heat, light, air conditioning or telecommunications equipment or lines, or other equipment if applicable, delays caused by customs authorities, provided that the party experiencing such circumstances immediately notifies the other party in writing of the circumstances and minimizes, to the extent reasonably practicable, the impact of such circumstances on the performance of the obligations under the Agreement.

26 Limitation of liability

26.1 Canada Post reserves the right to independently review and verify any and all claims made by the Customer arising from missed delivery and/or service commitments.

26.2 Except as specified in the Customer Guide for the Product or Service, Canada Post shall not be responsible for any direct, indirect, general, special or consequential damages arising out of the Agreement.

27 Termination

27.1 Either party may terminate this Agreement at any time, without cause, by giving 30 calendar days' written Notice to the other.

27.2 Either party may immediately terminate this Agreement upon written Notice to the other party if at any time during the Term:

- a) either party ceases to carry on business or makes a sale in bulk of all or substantially all of its assets; or
- b) either party becomes insolvent or bankrupt, or files any proposal or makes any assignment for the benefit of creditors; or
- c) a receiver, trustee or other person with like powers is appointed to handle the affairs or property of either party; or
- d) an order is made for the winding up or liquidation of either party; or
- e) either party continues to be in default of any of its obligations after being provided 30 calendar days' Notice of the default.

27.3 Should the Customer fail to purchase Products and Services under this Agreement for a period of more than 12 consecutive months, Canada Post may terminate the Agreement or amend the List of Authorized Users without notice.

27.4 Termination of this Agreement shall be without prejudice to any rights of the Customer or Canada Post that have accrued prior to the date of termination.

27.5 Neither party shall have a right to damages as a result of termination of this Agreement.

28 Notices

28.1 Any Notice given by either party shall be in writing and delivered personally, by Registered Mail, by Priority™, by Expedited Parcel™ or by Xpresspost™. Alternatively, Notices regarding Amendments to this Agreement by Canada Post may be sent to the Customer via email or by Canada Post posting such changes on Canada Post's website (canadapost.ca/notice), including in particular canadapost.ca/customerguides, which will be deemed received upon posting.

Notices to Canada Post shall be sent to:

AGREEMENT MONITORING
CANADA POST CORPORATION
2701 RIVERSIDE DR SUITE B0230
OTTAWA ON K1A 0B1

Notices to the Customer shall be sent to the Customer's prime contact at the mailing or email address set out in the Agreement Activation Form.

28.2 Notices delivered personally shall be deemed received at the time of delivery, Notices sent by Registered Mail and Expedited Parcel shall be deemed received on the fourth Business Day following the date of mailing, and Notices sent by Priority or Xpresspost shall be deemed received on the second Business Day following the date of mailing. Weekend and statutory holiday mailings will count as originating on the following Business Day.

28.3 Either party may change its address by giving Notice to the other party.

28.4 The Customer agrees that Canada Post may update the Customer's address information obtained from any source, including any Mail Forwarding request form submitted to Canada Post, for the purpose of contacting the Customer with respect to this Agreement.

29 Confidentiality

29.1 Except as may be required by law or for those Terms and Conditions that have been made publicly available by Canada Post, neither party nor their employees (including directors and officers) or agents shall disclose to any third party, with the exception of Authorized Users, prices or any other Terms or Conditions contained in this Agreement.

29.1.1 For clarity, Confidential Information does not include such observations and general knowledge of consumer and business trends in the purchase and sale of goods and services as a party to this Agreement may learn in providing or receiving any product or service under this Agreement and uses in the development and sale of new products and services.

29.2 Each party to this Agreement (the "Receiving Party") agrees to hold all Confidential Information of the other party (the "Disclosing Party") in confidence and not use any Confidential Information other than permitted by this Agreement. The Receiving Party shall not disclose any Confidential Information of the Disclosing Party without the prior written consent of the Disclosing Party, other than to those employees, agents, subcontractors or representatives of the Receiving Party who have a need to know such Confidential Information for the purposes contemplated in this Agreement.

29.3 Section 29.2 will not apply to any information which:

- a) is publicly available;
- b) is independently developed by the Receiving Party;
- c) is known by the Receiving Party without restriction on disclosure prior to its initial disclosure by the Disclosing Party;
- d) is lawfully received from a third party on a non-confidential basis; or
- e) is required to be disclosed by government or court order or other legal process, provided that the Receiving Party will promptly notify the disclosing Party of such requirement and will take reasonable steps to permit the Disclosing Party to prevent or limit such disclosure.

29.4 The Confidential Information shall be maintained by the Receiving Party in the same manner as the Receiving Party keeps its own Confidential Information of a similar nature and in any event shall be kept in accordance with the same care as a reasonable and prudent person would care for such Information.

29.5 Canada Post has policies and procedures in place to protect the Confidential Information and Personal Information, as defined in the [Privacy Act](#) that it handles. Canada Post is subject to the federal *Privacy Act* and the [Canada Post Corporation Act](#). Any third parties who are involved in handling Confidential Information on behalf of Canada Post are required to agree to appropriate contractual provisions.

29.6 Upon execution of the Agreement, any confidentiality obligations set out in any other agreement, relating in any way to parcel services, entered into by the parties shall be subject to these General Terms and Conditions, including, without limitation, the limitation of liability in Section D. In the event of any conflict or inconsistency between the terms and conditions of such agreement and these General Terms and Conditions, these General Terms and Conditions shall prevail to the extent of the conflict or inconsistency.

30 Language

30.1 It is the express wish of the parties that this Agreement, as well as all related documents, be written in the English language. Les parties ont demandé expressément que la présente ainsi que tout document afférent soient rédigés en anglais.

31 Ownership of Mail (excludes Business Reply Mail service)

The Customer agrees that Items mailed under this Agreement will be mailed only on the Customer's or its Authorized User's behalf, and that Items will not include commingled mail, being consolidated mail of a type or from sources other than those approved by Canada Post.



Commercial Mail
Appendices



Commercial Mail

Appendix A: Brick-piled Mail items

Brick-piled Mail is a way used to secure mail items without containers onto a pallet or in a monotainer. You can use pallets and monotainers for transportation (as a single unit) of mail items from your location to an approved Canada Post facility where the mail will be deposited.

What items can be Brick-Piled

Description	ILM	PUBS	BRM	IILP
Machineable – Oversize items	annual reports only	N/A	N/A	N/A
Special Handling and Delivery Facility Presort	N/A	yes	N/A	N/A

Type	Filling shipping units–Minimum	Filling Shipping units–Maximum
Pallet	<ul style="list-style-type: none"> for Local: height 100 mm (3.4 in.) – one row for Forward: height 200 mm (7.9 in.) – two rows 	<ul style="list-style-type: none"> Height: 1.5 m (4.9 ft.) Weight: 900 kg (1 ton) (Canada Post pallet weighs 9 kg [19.8 lb.])
Monotainer	<ul style="list-style-type: none"> Mail destined within the province of deposit – 50% of the height Mail destined outside the province of deposit – 75% of the height 	<ul style="list-style-type: none"> Height – 1.115 m (3.65 ft.) Weight – 900 kg (1 ton)

Pallets and how to build rows on pallets or in monotainers

1. Ensure the pallet is right side up.
2. Cover the holes of the pallet with a suitable cardboard liner.
3. First row: place bundles of mail lengthwise along the length of the pallet or monotainer to fully cover the entire pallet. The centre of the pallet must not be left empty.

Note: Bundles cannot be strapped or bound together and each secured bundle must be loosely piled. Bundles cannot exceed 200 mm (8 in.).

4. Second row: place bundles of mail lengthwise along the **width** of the monotainer/pallet and alternate the direction of the bundles to ensure an even and stable load during handling.
5. Pallets with loads that exceed 500 mm (19.7 in.) in height must have a cardboard liner at the halfway mark. When using a cardboard liner, face the bundles above and below the cardboard liner the same way instead of opposite length/width-wise.
 - Mail with spines: requires a cardboard liner for each new row for pallets and monotainers. Alternate the facing of spines for each row. Turn the books 180 degrees instead of 90 degrees as with other mail types.
 - Maximum height **including** base and pallet cap is 1.5 m (4.9 ft.) (pallet cap can be made of wood or sturdy paper/cardboard).
6. Completed pallets are to be capped on top of the load.
 - Monotainers do not require caps if brick-piled properly.
 - All pallets must be securely fastened and structurally sound.
7. Three layers of stretch-wrapping is to be applied around the pallet and its load, or
8. Cross-strapping is applied (metal strapping is not permitted).

Note: When the mail items are irregularly shaped or have a glossy finish and may slide around, four cross straps must be applied encompassing both the pallet cap and bottom to ensure the load is secure. For all other mailings, the four cross straps are optional, but highly recommended for additional security of all loads.

9. Completely secured pallet (Canada Post may refuse improperly secured pallets).

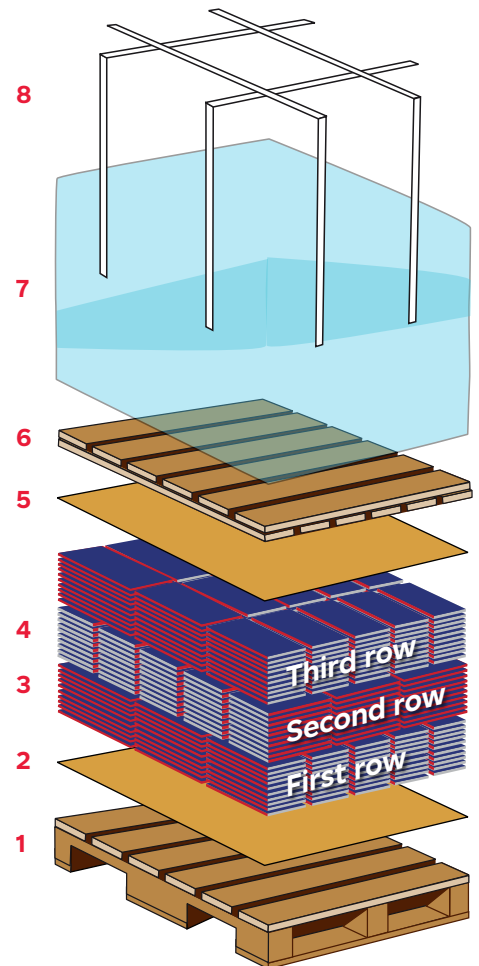
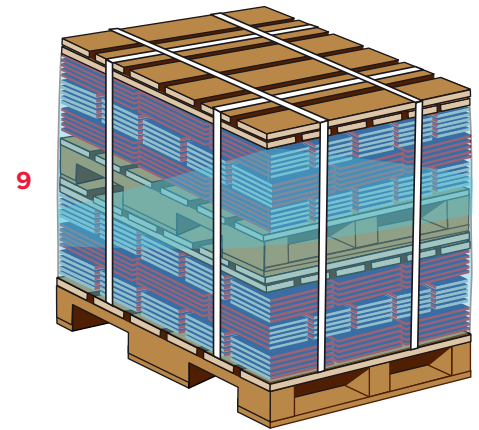

Appendix B: Pallet construction specifications

Pallet construction specifications

Pallets must conform to:

- ASTM – D1185 – [Standard Test Methods for Pallets and related Structures Employed in Materials Handling and Shipping](#);
- ISO-8611 – [Pallets for Materials Handling – Flat Pallets – Part 3: Maximum Working Loads](#);
- [Uniform Standard for Wood Pallets by National Wooden Pallet & Container Association \(USA\)](#).

Pallet must be built so the bottom deck boards do not obstruct entry by a forklift; should be accessible by a forklift on all four sides and by a hand jack on two sides.

Openings for forks must be:

- at least 102 mm (4 in.) in height on the sides of the pallet without bottom deck boards; and
- at least 89 mm (3.5 in.) in height on the sides with bottom deck boards.

Critical dimensions of mail handling equipment:

- distance across forks: maximum 686 mm (27 in.);
- distance between forks: minimum 204 mm (8 in.);
- height of the lowered fork: maximum 89 mm (3.5 in.).

Additional wooden pallet requirements

- The block design is recommended;
- Must be able to withstand temperatures of -40°C to 40°C, and severe weather conditions;
- Must not have critical defects (i.e., exposed nails, significant splits, missing wood, decay or damaged parts);
- The top surface must be flat allowing for safe loading and unloading of mail without tipping or sliding.

Appendix C: Preparing monotainers with mixed Lettermail services

Mixing Lettermail services

Customers with small numbers of remnant containers for different Lettermail service category:

- Standard and Oversize Machineable Incentive Lettermail and
- Standard and other Lettermail (meter or postal indicia) may place the containers within the same monotainer* provided the following requirements are met:
 - only one mixed monotainer is permissible per deposit and per Order. If there are enough containers to make one full mixed services monotainer, the monotainer must be filled to capacity before starting another mixed services monotainer
 - the containers for each service must be physically separated within the monotainer (e.g., by corrugated plastic or cardboard that covers the entire surface area of the monotainer)
 - customers should identify the number of containers per Order in the EST if they are mixing mail from different Orders in the last monotainer. If the number of containers to be used with the mailing is unknown at the time the EST Order is created, it may be hand written in the appropriate container box on the Order prior to induction of the mailing to Canada Post
 - must be properly labelled with the Lettermail service and option names. In addition, if the mail is from various Orders, the Order number(s) of the mail contained therein must be indicated on each container label.
 - Mixed Lettermail services monotainers must have labels that clearly indicate:
 - › an Order number(s)
 - › types of the Lettermail services included in the monotainer (service name and service option).
 - if items are brick-piled within the mixed services monotainer (only allowed for annual financial reports – Oversize Incentive Lettermail), Standard items in letterflatainers (LFTs) can be placed on top of brick-piled mailings.

* In cases where monotainers are not available from Canada Post, pallets (skids) will be accepted, as long as the pallet (skid) is clearly marked as per the requirements above and the containers are securely placed on the pallet (skid).

Examples of acceptable mixed Lettermail services monotainers

Example 1

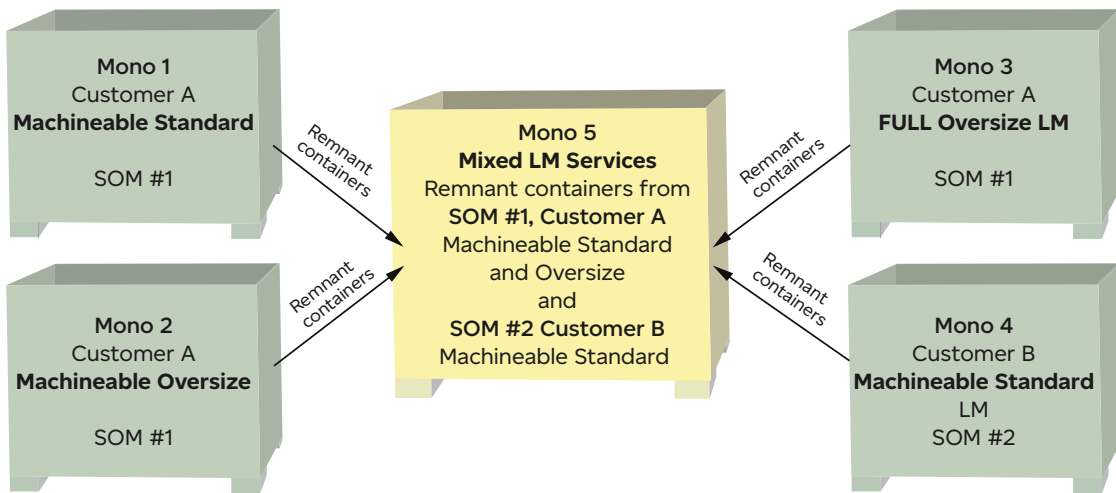

Example 2

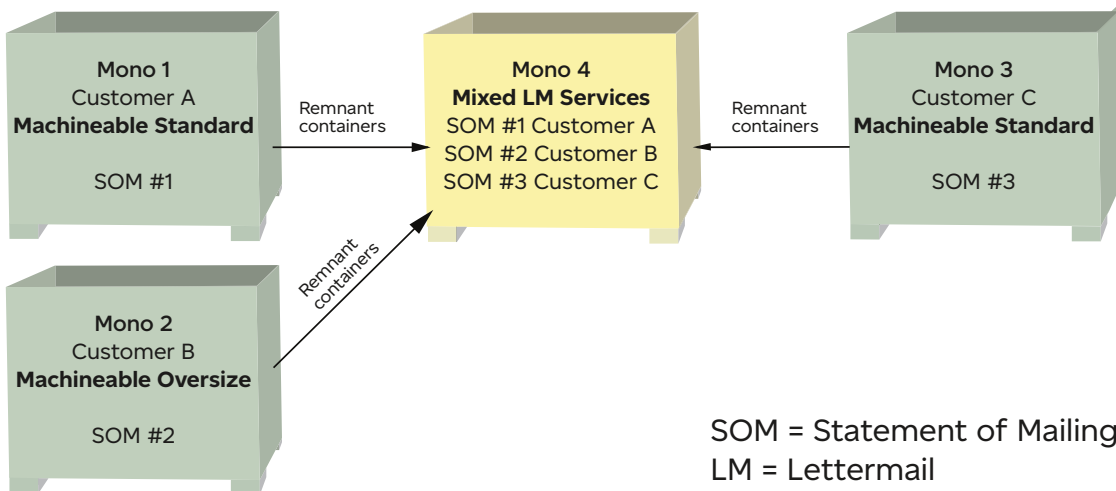

SOM = Statement of Mailing
LM = Lettermail

Labelling containers within the mixed Lettermail services monotainers

All containers within the mixed Lettermail services monotainer must be properly labelled with the Lettermail service and option names. In addition, if the mail is from various Orders, the Order number(s) of the mail contained therein must be indicated on each container label.

Labelling Monotainers Containing Mixed Lettermail Services

Mixed Lettermail services monotainers must have labels that clearly indicate:

- an Order number(s)
- types of the Lettermail services included in the monotainer (service name and service option).

LETTERMAIL STANDARD MACHINEABLE SOM # C123456789	LETTERMAIL STANDARD MACHINEABLE SOM # C234567899
LETTERMAIL OVERSIZE MACHINEABLE SOM #C345678899	LETTERMAIL OVERSIZE MACHINEABLE SOM #C987654321

Appendix D: Using a spreadsheet application to sequence your Publications Mail mailing list

You may use a spreadsheet application, such as Microsoft® Excel®, to sequence your mailing list by postal code.

Sort functions within spreadsheet applications enable alphanumeric sequencing. While the ordering of the National Presortation Schematic (NPS) is primarily alphanumeric, its sequencing will differ slightly from your spreadsheet sequencing outcome. For this reason, all alphanumerically sequenced mailings must also be matched against the most current version of the NPS.

The following example is provided for illustration only. It shows how you can use Microsoft Excel 2003 to sequence your mailing list. The sort function may vary depending on what software application you use.

If you are using Microsoft Excel, follow these steps:

Steps

1. Open a new spreadsheet.
2. List all of your postal codes in column “A”.
3. Highlight column “A” and sort it in ascending order.

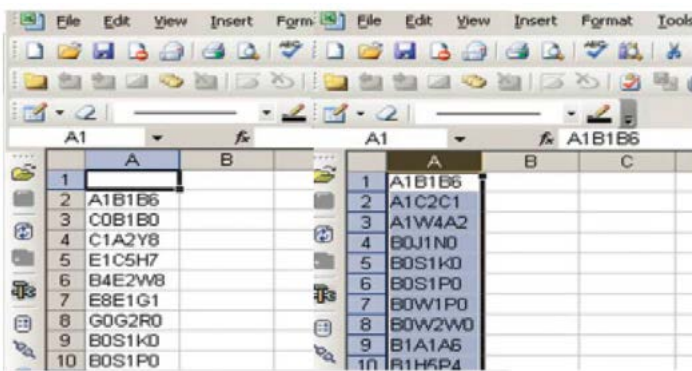

4. Create column heading above your postal codes data (for example, “Pcode”).
5. Select cell “A1”, then select “Data”, “Filter”, “AutoFilter” from the main menu. A button featuring a downward arrow will appear in cell “A1”. This will be used to sort the postal codes by their first letter.

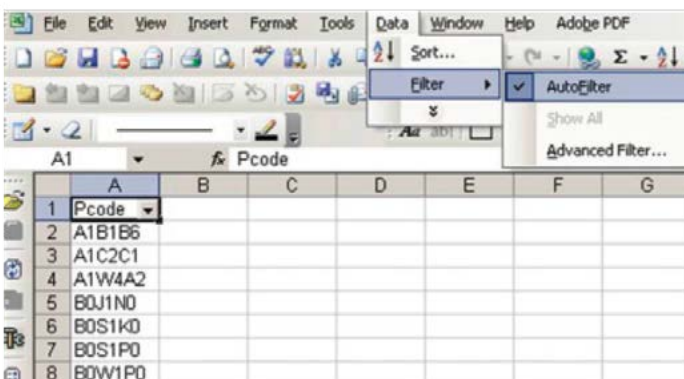

® Microsoft and Excel are registered trademarks of Microsoft.

- Click on the downward arrow and select “Custom...”. In the Custom AutoFilter window, set the filter criteria as, “Show rows where: Pcode equals A*”.

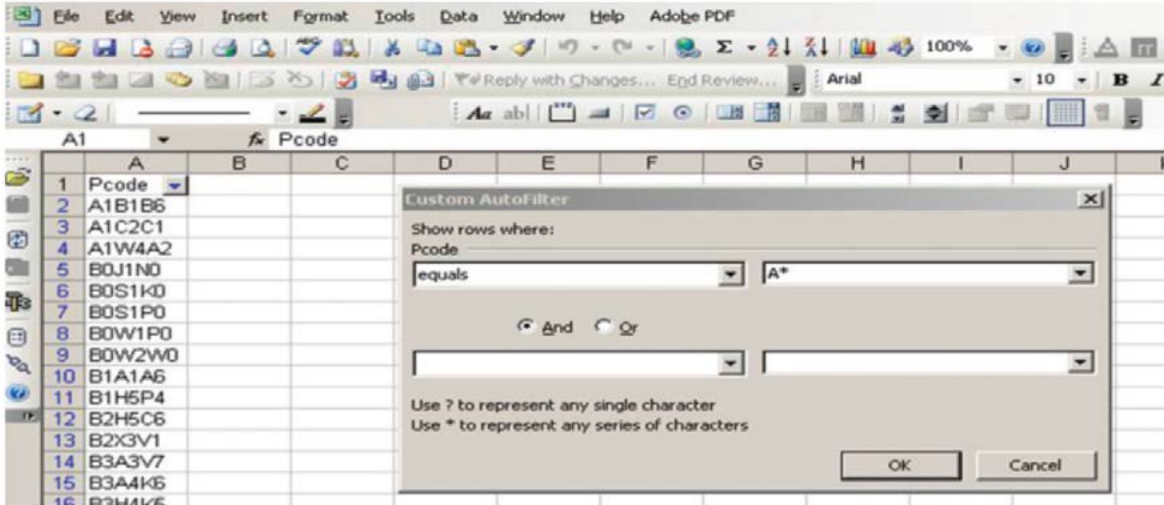

- Select “OK”. The filter will be applied. Only postal codes that start with an “A” will be displayed in column “A”. Highlight the postal codes, then “Copy” and “Paste” them below all the postal codes in column “A”. Follow the same process to filter the postal codes by other alpha characters (B, C, E, G, J, etc.).

	A	B	C	D	E	F	G	H	I
1091									
1092	"A"		"B"		"C"		"E"		"G"
1093	A1B1B6		B0J1N0		C0B1B0		E1C5H7		G0G2R0
1094	A1C2C1		B0S1K0		C1A2Y8		E1V2K3		G0S1Z0
1095	A1W4A2		B0S1P0				E2A2R7		G1L3R9
1096			B0W1P0				E3B7S3		G2J1B7
1097			B0W2W0				E4L3H9		G2K2J1
1098			B1A1A6				E8E1G1		G4R2G8
1099			B1H5P4				E8E1G5		G5L4B6
1100			B2H5C6				E8E2K6		G5M1B4
1101			B2X3V1						G6X2A4
1102			B3A3V7						G9A2G7
1103			B3A4K6						G9H3V4
1104			B3H4K6						

- Once the postal codes have been initially sorted by their first letter, apply filters to each postal codes list to further determine groupings. For example, apply the data AutoFilter to the “B” postal codes column (column “C”, cell “C1092”), then apply the Custom Autofilter criteria that begins with B0*. Repeat this process for the postal codes (B1*, B2*,... B9*), with the NPS grouping parameters applied to determine the groupings for the DF or DCF levels.
- In the example above, since there are not enough items with “A” and “C” postal codes to make FCP groupings, these items will be considered Residue. Further filtering as per the NPS will be required to determine if DF or DCF groupings can be created for items with “B”, “E”, “G” and “H” postal codes. If there are not enough items to create a DF grouping, they will have to be consolidated to the DCF or FCP levels as per the NPS.

Separating mail items by areas of destination

Separating mail items by areas of destination. Begin by separating mail items by their province or district of destination.

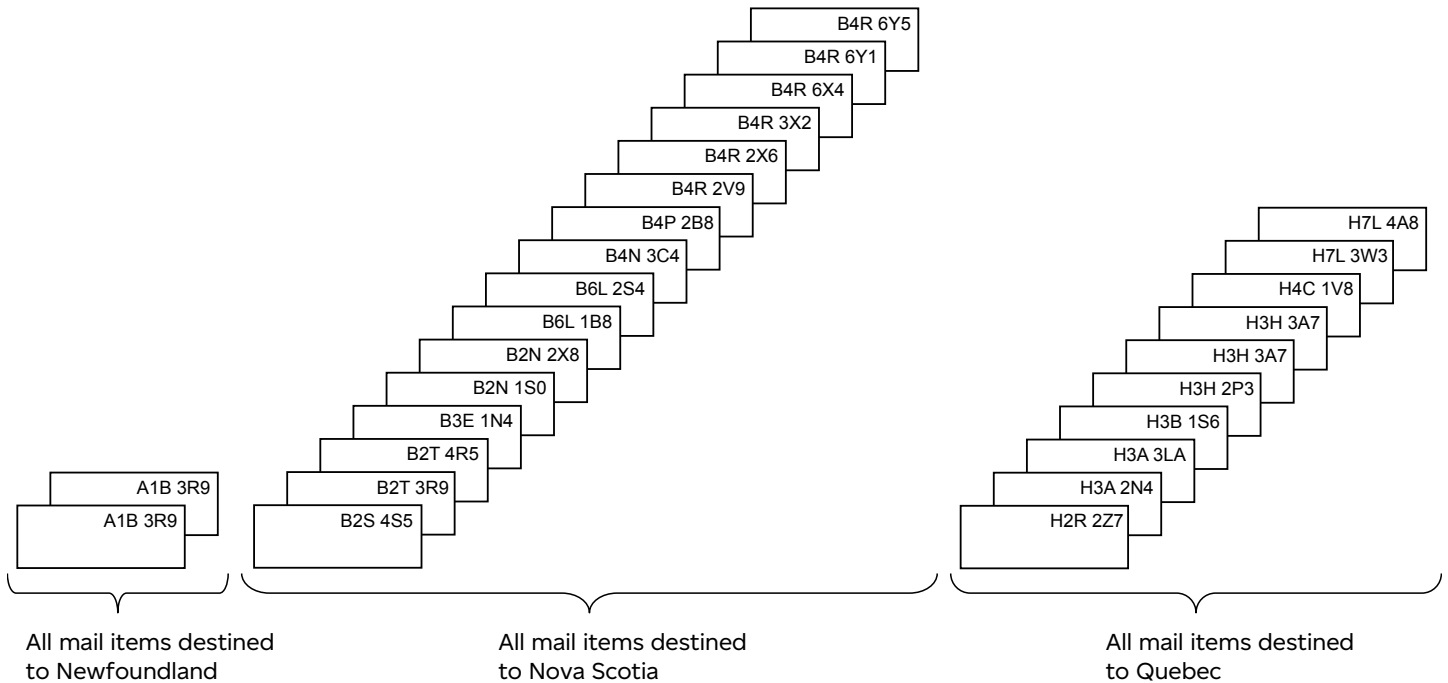

Mail items must be sequenced within each grouping created.

THEN...

If there are not enough items to create an FCP grouping, create Residue grouping; however, if there are enough items to create an FCP grouping, check the NPS if DCF grouping(s) can be created.

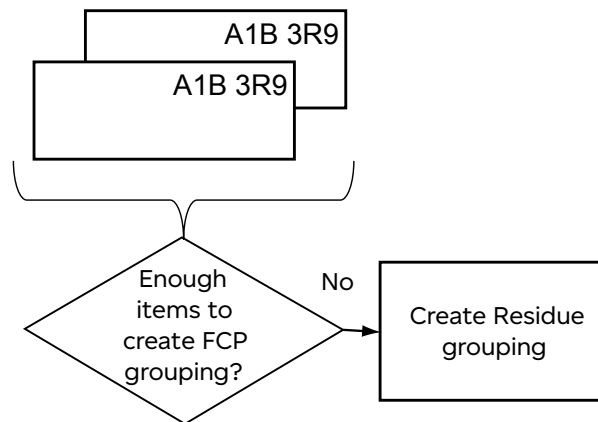

If there are not enough items to create a DCF grouping, create an FCP grouping; however, if there are enough items to create a DCF grouping, check the NPS if DF grouping(s) can be created.

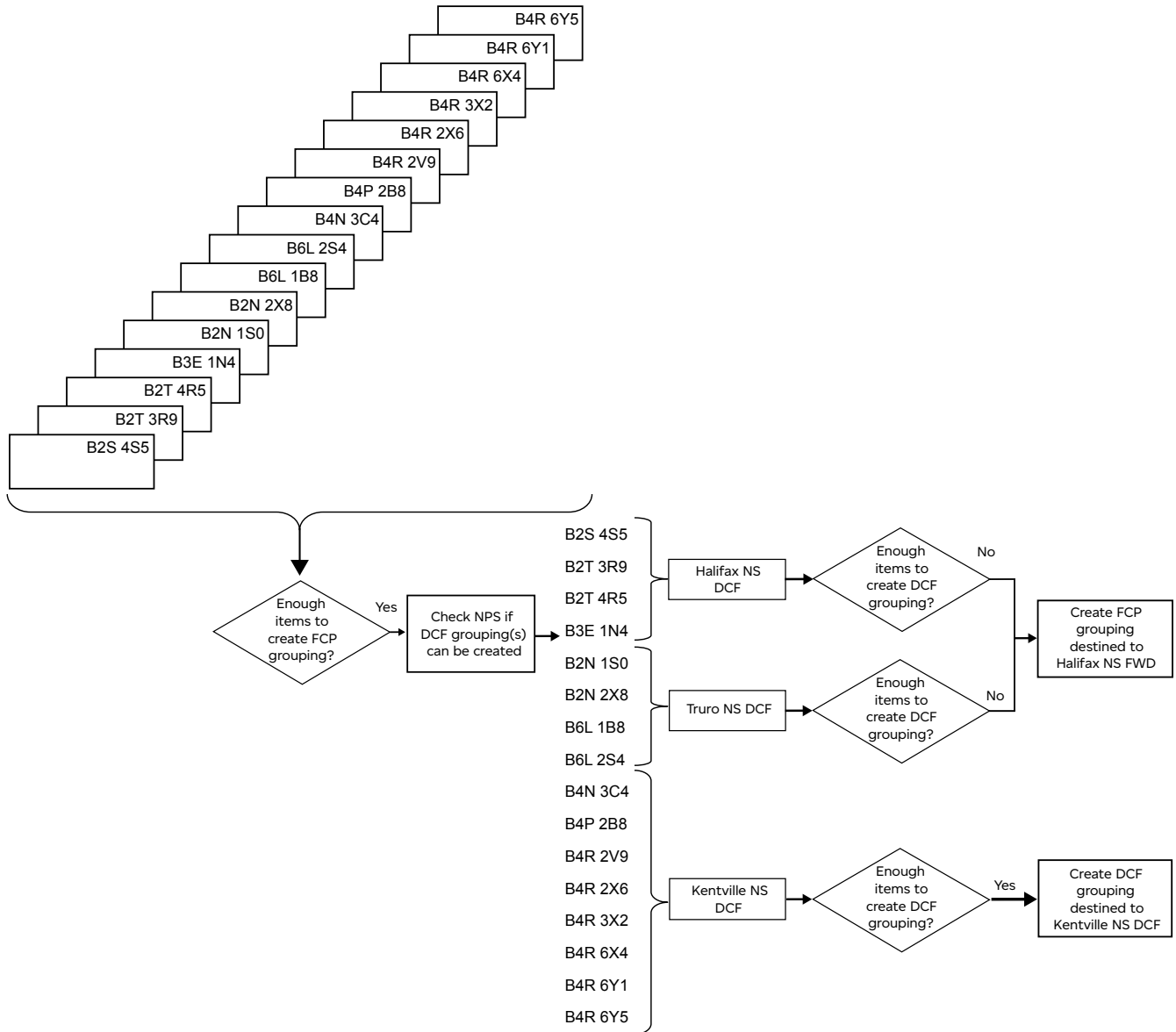

THEN...

If there are not enough items to create a DF grouping, create a DCF grouping or consolidate to FCP or Residue groupings; however, if there are enough items to create a DF grouping, create DF grouping(s).

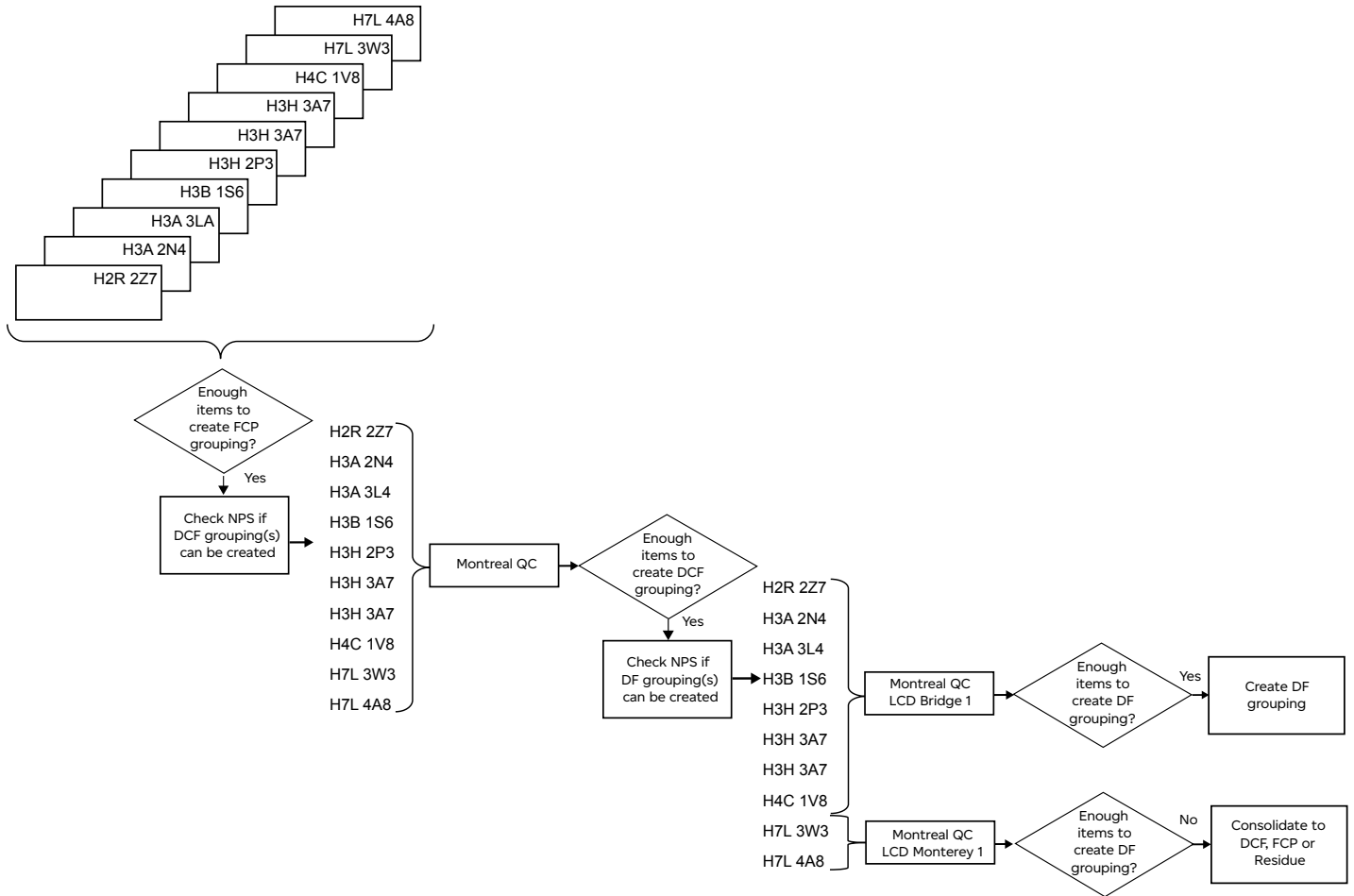

Appendix E: Weighted average weight

A mailing may be comprised of items of varying weights (including items above and below the base weight). In such cases, you may enter information on the Order (Statement of Mailing) using the weighted average weight per item.

Separate average weights can either be calculated by EST 2.0 or manually and entered on the Order for the following weight categories:

Incentive Lettermail

Category	Weight category
Machineable Standard	up to 30 g (1 oz.)
	over 30 g up to 50 g (over 1 oz. up to 1.7 oz.)
Machineable Oversize	up to 100 g (3.5 oz.)
	over 100 g up to 500 g (over 3.5 oz. up to 17.6 oz.)

Example: 5,000 items of Standard mail; 2,500 items weigh 30 g (1 oz.) and 2,500 items weigh 20 g (0.7 oz.). Therefore, the weighted average would be 5,000 at 25 g (0.2 oz.).

Size/item	A Number of items	B Weight per item	C Total weight	D Total (C) divided by total (A) = weighted average weight
Standard	2,500	30 g	75,000 g	N/A
Standard	2,500	20 g	50,000 g	N/A
Total	5,000	N/A	125,000 g	25 g

Publications Mail

Category	Size/Item	Weight category
Machineable	Standard	up to 50 g (1.76 oz.)
	Oversize	up to 100 g (3.5 oz.)
Special Handling	Standard and Oversize	up to 200 g (6 oz.)
	Standard and Oversize	over 200 g up to 1.36 kg (over 6 oz. up to 3 lb.)
Delivery Facility Presort	Standard and Oversize	up to 100 g (3.5 oz.)
	Standard and Oversize	over 100 g up to 1.36 kg (over 3.5 oz. up to 3 lb.)

When you enter the individual weights in the EST 2.0, the application determines the appropriate weight bands. In the Order one line is created for each weight band with the proper quantity and average weight. The Order displays both the actual weight and the calculated average weight. You still have the option to enter an average weight.

Example: A customer has a mailing of 5,000 items of Special Handling. The mailing is comprised of various weights above and below 200 g. In this example, two calculations of average weight must be completed and entered separately on the Order for pricing purposes: one entry for the portion of the mailing up to 200 g and one entry for the portion over 200 g.

Weighted average weight calculation – up to 200 g

Special Handling	A Number of items	B Weight per item	C Total weight	D Total (C) divided by total (A) = weighted average weight
Standard	1,500	30 g	45,000 g	N/A
Standard	500	45 g	22,500 g	N/A
Total	2,000	N/A	67,500 g	33.8 g

Weighted average weight calculation – over 200 g

Special Handling	A Number of items	B Weight per item	C Total weight	D Total (C) divided by total (A) = weighted average weight
Standard	1,000	255 g	255,000 g	N/A
Standard	2,000	260 g	520,000 g	N/A
Total	3,000	N/A	775,000 g	258.3 g